

# Calidad Profesional



**ALYCO**

A collection of various professional tools including wrenches, sockets, and screwdrivers, arranged on a textured surface. The image is semi-transparent and serves as a background for the lower portion of the cover.

Catálogo Tarifa  
**2020**

# Bienvenido al nuevo catálogo de ALYCOTOOLS 2020



#### EXPERIENCIA

Más de 108 años en la compra de materia prima de la máxima calidad, la fabricación y comercialización de productos de forja y herramientas de mano.

#### PERSONAS

Labor y experiencia enfocadas a la satisfacción del cliente y a la innovación de productos y procesos.

#### COMPROMISO

Alto compromiso con las personas, proveedores, clientes, entorno social y el ecosistema global.



#### CATALOGO

Catálogo completo de herramientas profesionales para diversos sectores priorizando calidad, rendimiento y ergonomía.

#### INNOVACION

Innovación continua de productos y procesos, en constante adaptación a las necesidades del cliente.

#### SATISFACCION DEL CLIENTE

Compromiso de satisfacción en la información, calidad y cumplimiento del servicio.



# INDICE GRAFICO

## MONTAJES páginas 8-19



## ALMACENAJE páginas 20-53



## ALICATES páginas 54-79



## LLAVES páginas 80-107



## LLAVES MACHO páginas 108-117



## DESTORNILLADORES Y PUNTAS páginas 118-137



## LLAVES DE VASO páginas 138-165



**PERCUSION páginas 166-181****CORTE Y TALADRADO páginas 182-205****JARDINERIA páginas 206-209****CONSTRUCCION páginas 210-229****FONTANERIA Y MEDICION páginas 230-249****ILUMINACION Y ELECTRICIDAD páginas 250-265****HERRAMIENTA VARIA páginas 266-283****HERRAMIENTA ANTICHISPA páginas 284-297**

# NOVEDADES 2020



Carro de 7 cajones reforzado



Carro de 8 cajones



Arcón metálico de 4 cajones



Mesa de trabajo con 3 cajones



Soporte magnético



Maleta de aluminio



Conjunto de taller de 8 módulos



Mochila de nylon



Bolsa de nylon



Tijera electricista



Bolsa de nylon



Trolley



Cuchillo pelacables



Llave acodada aislada



Llave ajustable de boca reversible



Llave dinamométrica de disparo Slipper



Llave dinamométrica de 1"



Llave de vaso 1/2" bihexagonal



Más medidas en vasos de impacto de 1/2", 3/4" y 1"



Juego de vasos 3/8" aislados



Martillo de bola



Martillo de ajustador



Martillo de uña curva



Cuña para madera



Hacha



Cuchilla  
cerámica



Cutter  
reforzado



Cutter



Cutter de  
seguridad



Rodilleras



Llave  
Stillson



Bocas de  
recambio

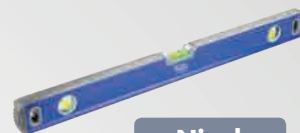

Nivel  
magnético



Foco  
recargable COB



Tiralíneas

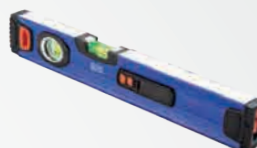

Nivel  
laser



Nivel  
angular



Linterna bifocal  
COB



Linterna  
extrafina



Proyector  
SMD COB



Linterna  
bifocal COB



Linterna de  
bolsillo



Linterna frontal  
recargable



Proyectores LED  
con trípode



Foco SMD  
plegable



Enrollables de  
alta seguridad



Masa  
magnética



Juego de  
2 pinzas



Base  
múltiple



Prolongador  
de cable



Imán de  
esquina



Alicate  
antichispa



Llave de golpe  
antichispa



Maceta  
de cobre

# CERTIFICADOS DE CALIDAD

Validez hasta 08-2020



# COMPROMISO DE SERVICIO



**SERVICIO**

**100% SEGURO**

**100% RAPIDO**



Condiciones vigentes a la fecha 01-01-2020 para la Península Ibérica.



# TARIFA DE PRECIOS 2020

## Condiciones de la tarifa



### PEDIDO MINIMO

No hay cifra de pedido mínimo.



### PRECIOS

Precio venta público (P.V.P.) recomendado. Impuestos no incluidos.



### PORTES

Los cargos de portes correspondientes a los envíos serán **pagados por Alyco**, en caso de pedidos por un importe neto superior a:

1. España peninsular: **100 Euros.**
2. Portugal peninsular: **150 Euros.**
3. Baleares: **300 Euros.**
4. Canarias: **900 Euros.**

El resto de los envíos serán a portes debidos con tarifa plana de **9 Euros**, cuando los portes sean contratados por Alyco, en cuyo caso serán cargados en factura.

En caso de envío por la agencia del cliente a su cuenta, se cobrarán **9 Euros** por gastos de gestión.



### PAGOS

**A los 60 días** de fecha de factura **por recibo domiciliado o transferencia.**



### VIGENCIA DE ESTA TARIFA

Esta tarifa anula cualquier otra edición anterior. Alyco se reserva el derecho de modificar los modelos sin previo aviso. Las especificaciones de este catálogo no constituyen un compromiso contractual.

## Otras condiciones de venta



### COMPROBACION DE ENVIO

Para reclamaciones por faltas de producto comprobar que los cierres de los paquetes no están abiertos antes de firmar el albarán de la agencia de transporte. En caso contrario hacer constar en el albarán la incidencia y **reclamar en menos de 24 horas a Alyco.**



### DEVOLUCION DE LA MERCANCIA

Se aceptarán por error de envío o por defectos atribuibles a Alyco dentro de los 30 días desde la fecha de expedición.



### GARANTIA

Todos los artículos están garantizados contra defectos de materiales o fabricación. Esta garantía cubre exclusivamente el cambio o reparación de las herramientas defectuosas.



### DESCARGA DEL FICHERO DE PRECIOS

Puede descargar el fichero Excel de código, descripción, precio, código de barras y páginas de catálogo en la página **[www.alycotools.com/descargas](http://www.alycotools.com/descargas)**



### DESCARGA DE IMAGENES DE PRODUCTOS

Puede descargar las imágenes de todos nuestros productos, en la página **[www.raizferretera.com](http://www.raizferretera.com)** (solicitar claves e instrucciones)



## 01 Montajes



**Carro con herramientas**

**9**



**Carro con herramientas**

**13**



**Módulo para carro**

**14**



**Caja con herramientas**

**16**



**Bolsa con herramientas**

**17**



**Juego combinado**

**18**



**Maleta con herramientas**

**19**

**Carro de 7 cajones reforzado con herramientas**



**Carro 192825**

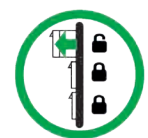
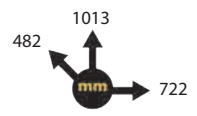

**SISTEMA ANTIVUELCO**



Carro con accesorios

**COMPOSICION COMPLETA**

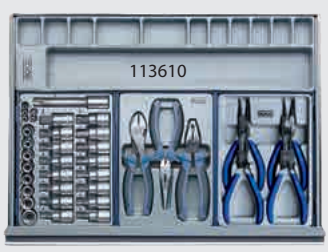

192490 101210 101220



191096 191296 191196

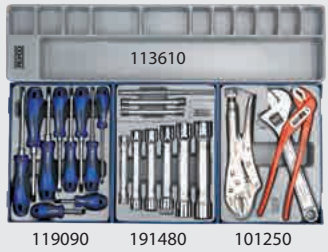

119090 191480 101250

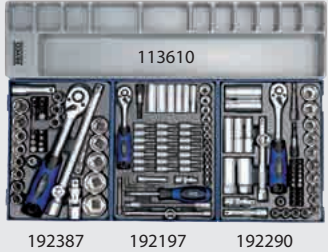

192387 192197 192290



113612



Cerradura centralizada

**COMPOSICION BASICA**



113612



192387 192197 101250

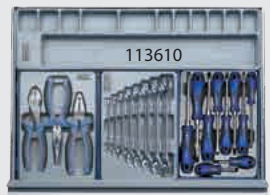

101210 191096 119090

Code	Descripción	Nº Piezas	P.V.P. unid. €
<b>192826</b>	<b>CARRO + COMPOSICION COMPLETA</b>	253	<b>1.620,00</b>
<b>192827</b>	<b>CARRO + COMPOSICION BASICA</b>	141	<b>1.176,00</b>

Características del carro en pág. 21 / Accesorios y recambios en pág. 26-29

Carro de 7 cajones con herramientas



Carro 129725

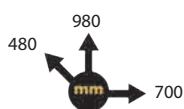

SISTEMA ANTIVUELCO

**Nuevo**



Cerradura centralizada

### COMPOSICION COMPLETA

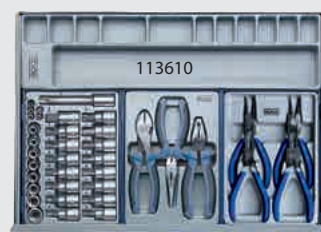

192490 101210 101220



191096 191296 191196



119090 191480 101250



192387 192197 192290



113612

### COMPOSICION BASICA



113612



192387 192197 101250

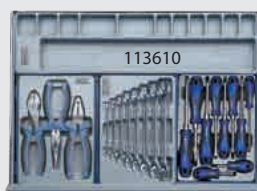

101210 191096 119090

Code	Descripción	Nº Piezas	P.V.P. unid. €
129727	CARRO + COMPOSICION COMPLETA	253	1.468,00
129724	CARRO + COMPOSICION BASICA	141	1.024,00

Características del carro en pág. 22 / Accesorios y recambios en pág. 26-29

**Carro de 7 cajones con herramientas**



Cerradura centralizada



**Carro 192710**

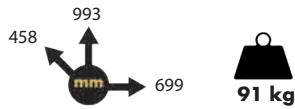

**COMPOSICION COMPLETA**

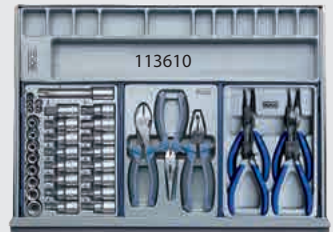

**COMPOSICION BASICA**



113612



192387 192197 101250



101210 191096 119090

Code	Descripción	Nº Piezas	P.V.P. unid. €
<b>192712</b>	<b>CARRO + COMPOSICION COMPLETA</b>	253	<b>1.363,00</b>
<b>192709</b>	<b>CARRO + COMPOSICION BASICA</b>	141	<b>919,00</b>

Características del carro en pág. 23 / Accesorios y recambios en pág. 26-29

## Carro de 8 cajones con herramientas

**Nuevo**



Cerradura centralizada



Carro 129715



### COMPOSICION COMPLETA

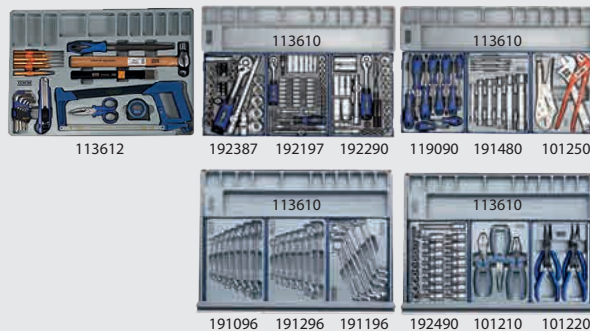

### COMPOSICION BASICA



Code	Descripción	Nº Piezas	P.V.P. unid. €
<b>129716</b>	<b>CARRO + COMPOSICION COMPLETA</b>	253	<b>1.388,00</b>
<b>129714</b>	<b>CARRO + COMPOSICION BASICA</b>	141	<b>944,00</b>

Características del carro en [pág. 24](#) / Accesorios y recambios en [pág. 26-29](#)

## Carro de 5 cajones con herramientas

**Nuevo**



Cerradura centralizada



Carro 129720

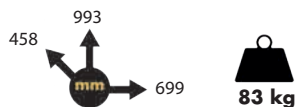

### COMPOSICION BASICA



Code	Nº Piezas	P.V.P. unid. €
<b>129719</b>	137	<b>908,00</b>

Características del carro en [pág. 24](#)  
Accesorios y recambios en [pág. 26-29](#)

**Nuevo**

**Banco de trabajo móvil con herramientas**



Cerradura centralizada



**Banco 192678**



**COMPOSICION COMPLETA**

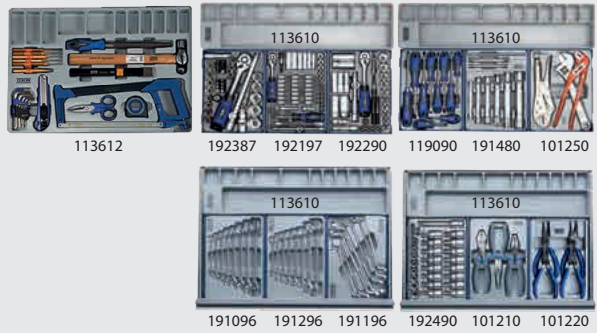

**COMPOSICION BASICA**

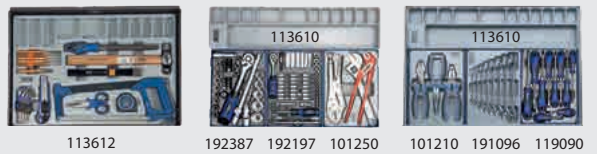

Code	Descripción	Nº Piezas	P.V.P. unid. €
<b>192679</b>	<b>CARRO + COMPOSICION COMPLETA</b>	253	<b>1.803,00</b>
<b>192680</b>	<b>CARRO + COMPOSICION BASICA</b>	141	<b>1.360,00</b>

Características del carro en pág. 22 / Accesorios y recambios en pág. 26-29

**Carro de taller ligero con herramientas**



Cerradura centralizada



**Carro 192780**

Se suministra desmontado

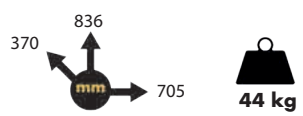

Code	Nº Piezas	P.V.P. unid. €
<b>192782</b>	139	<b>710,00</b>

Características del carro en pág. 24

## Estructura de almacenaje



113612 (113611 bandeja vacía)

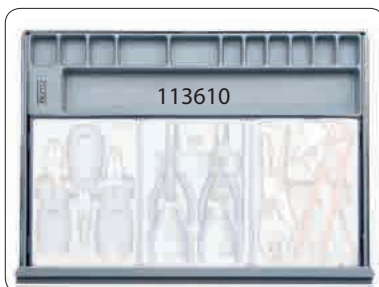

199002



199009

### COMPOSICION 113612

- 1 bandeja vacía 113611
- 1 martillo de bola 30 mm
- 9 llaves Allen 1'5 a 10 mm
- 1 lima de media caña
- 1 cortafío de 250 mm
- 5 botadores cilíndricos 2, 3, 4, 5, 6
- 1 granete 5 mm
- 1 flexómetro 3 m
- 1 cutter 18 mm
- 1 tijera electricista
- 1 arco de sierra

Code	Descripción	Medidas mm	P.V.P. unid. €
<b>113610</b>	<b>BANDEJA PARA CONSUMIBLES</b>	560x140	<b>5,83</b>
<b>199002</b>	<b>CAJA MODULAR VACIA</b>	255x185x48	<b>6,66</b>
<b>199009</b>	<b>MOLDE PARA HERRAMIENTAS</b>	255x185	<b>3,39</b>
<b>113612</b>	<b>BANDEJA ESPECIAL HERRAMIENTAS</b>	560x400x40	<b>102,45</b>
<b>113611</b>	<b>BANDEJA ESPECIAL VACIA</b>	560x400x40	<b>10,00</b>

## Bandejas modulares con herramientas



### JUEGO DE VASOS 1/2"

Code	Nº Piezas	P.V.P. unid. €
<b>192387</b>	39	<b>93,00</b>

### COMPOSICION 1/2" (192387)

- 1 Carraca de 72 dientes
- 16 Vasos: 10 a 20, 22, 24, 27, 30, 32 mm
- 2 Alargaderas: 75, 250 mm
- 1 Adaptador 1/2" M x 3/8" H
- 1 Adaptador vasos de 1/2"
- 1 Junta Universal
- 1 Adaptador puntas de 5/16"
- 16 puntas de 5/16": - Hex.: 8, 10, 12 mm
- Planos: 8, 10, 12 mm - PH2, PH3, PH4
- PZ3, PZ4 - T40, T45, T50, T55, T60



### JUEGO DE VASOS 1/4"

Code	Nº Piezas	P.V.P. unid. €
<b>192197</b>	53	<b>60,00</b>

### COMPOSICION 1/4" (192197)

- 1 Carraca de 72 dientes
- 13 Vasos: 4 a 14 mm
- 6 Vasos largos de 1/4": 6, 7, 8, 10, 12, 13 mm
- 2 Alargaderas: 50, 150 mm
- 1 Atornillador de 150 mm
- 1 Adaptador Vasos 1/4"
- 1 Alargadera flexible de 150 mm
- 1 Junta Universal / 1 Adaptador 3/8" H x 1/4" M
- 1 Adaptador Magnético para puntas de 1/4"
- 21 Vasos con Punta: - Hex.: 3, 4, 5, 6, 7, 8 mm
- Planos: 4, 5, 5, 7 mm - PH1, PH2, PH3
- PZ1, PZ2, PZ3 - T10, T15, T20, T25, T30, T40
- 4 Llaves Allen: 1'27, 1'5, 2, 2'5 mm



### JUEGO DE VASOS 3/8"

Code	Nº Piezas	P.V.P. unid. €
<b>192290</b>	49	<b>80,00</b>

### COMPOSICION 3/8" (192290)

- 1 Carraca de 72 dientes
- 14 Vasos: 8-19, 21, 22 mm
- 5 Vasos largos de 3/8": 8, 10, 13, 17, 19 mm
- 2 Llaves de Bujía: 16, 21 mm
- 2 Alargaderas: 75, 150 mm
- 1 Adaptador para vasos
- 1 Junta Universal / 1 Adaptador 3/8" M x 1/2" H
- 1 Adapt. magnético rápido para puntas de 1/4"
- 1 Adapt. para puntas de 1/4"
- 20 puntas - Hex.: 3, 4, 5, 6, 7, 8 mm
- Planos: 5'5, 7 mm - PH1, PH2, PH3
- PZ1, PZ2, PZ3 - T10, T15, T20, T25, T30, T40



### JUEGO DE VASOS 1/4" + 1/2"

Code	Nº Piezas	P.V.P. unid. €
<b>192490</b>	30	<b>72,00</b>

### COMPOSICION VASOS CON PUNTA (192490)

- 1/2" Torx Hembra: E10, E11, E12, E14, E16, E18, E20, E24
- 1/4" Torx Hembra: E4, E5, E6, E7, E8
- 1/2" Punta Hexagonal: 5, 6, 7, 8, 9, 10, 12, 14 mm
- 1/2" Punta Torx Inviolable: T20, 25, 27, 30, 40, 45, 50, 55
- 1/2" Punta Torx Serie Larga: T70



**Bandejas modulares con herramientas**



Ver composición en la página 57

**JUEGO ALICATES**

Code	Nº Piezas	P.V.P. unid. €
<b>101210</b>	3	<b>38,90</b>



Ver composición en la página 62

**JUEGO ALICATES SEEGER**

Code	Nº Piezas	P.V.P. unid. €
<b>101220</b>	4	<b>70,00</b>



**JUEGO TENAZAS + LLAVE AJUSTABLE**

Code	Nº Piezas	P.V.P. unid. €
<b>101250</b>	3	<b>54,00</b>



Ver composición en la página 82

**JUEGO LLAVES FIJAS**

Code	Nº Piezas	P.V.P. unid. €
<b>191096</b>	8	<b>32,90</b>



Ver composición en la página 84

**JUEGO LLAVES COMBINADAS**

Code	Nº Piezas	P.V.P. unid. €
<b>191296</b>	8	<b>48,93</b>



Ver composición en la página 86

**JUEGO LLAVES ACODADAS**

Code	Nº Piezas	P.V.P. unid. €
<b>191196</b>	7	<b>50,19</b>



Ver composición en la página 96

**JUEGO LLAVES DE TUBO FORJADAS**

Code	Nº Piezas	P.V.P. unid. €
<b>191480</b>	9	<b>107,21</b>



Ver composición en la página 128

**JUEGO DE DESTORNILLADORES**

Code	Nº Piezas	P.V.P. unid. €
<b>119090</b>	10	<b>40,47</b>

## Caja metálica de 5 bandejas con 80 herramientas



Caja 192735



Preparada para candado



Code	Nº Piezas	P.V.P. unid. €
<b>192736</b>	80	<b>350,00</b>

Características de la caja en pág. 40

## Caja metálica de 3 bandejas con 85 herramientas



Caja 192731

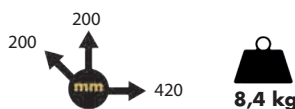

Preparada para candado



Code	Nº Piezas	P.V.P. unid. €
<b>192732</b>	85	<b>199,00</b>

Características de la caja en pág. 40

**Bolsa de nylon con herramientas aisladas**



**Bolsa 196880**

**COMPOSICION AISLADA**

1	101802 Alicates Universal 180 mm	1	101821 Alicates corte diagonal 160 mm	
4	Destornilladores	2	119311 (PH1x100)	
2	Boca recta 119304 (4x100) 119305 (5'5x125)	2	119312 (PH2x100)	

**COMPOSICION NO AISLADA**

1	108015 Tijera electricista	1	108030 Navaja electricista
---	----------------------------	---	----------------------------

Code	Nº Piezas	P.V.P. unid. €
<b>101410</b>	9	<b>91,00</b>

**Bolsa de nylon con herramientas**



**Bolsa 196880**

**COMPOSICION**

1	101202 Alicates Universal 180 mm	1	110302 Alicates corte diagonal 160 mm	
4	Destornilladores	1	Boca plana 119005 (5,5x125)	
1	Boca recta 119024 (4x100)	2	119031 (PH1x100) 119029 (PH2x100)	
1	108015 Tijera electricista	1	108030 Navaja electricista	

Code	Nº Piezas	P.V.P. unid. €
<b>101400</b>	9	<b>71,00</b>

**Bolsa de nylon pequeña con herramientas**



**Bolsa 196882**

**COMPOSICION**

- Tijera 108015
- Destornillador intercambiable 119120
- Alicates universal 101202
- Linterna 3W 190538

Code	Nº Piezas	P.V.P. unid. €
<b>101402</b>	5	<b>46,00</b>

## Juego de herramienta combinada aislada de 98 piezas



Carraca extensible de 1/2" y 1/4" 5° 72 T

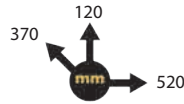

Code	P.V.P. unid. €	
<b>101460</b>	<b>303,31</b>	1

### COMPOSICION AISLADA

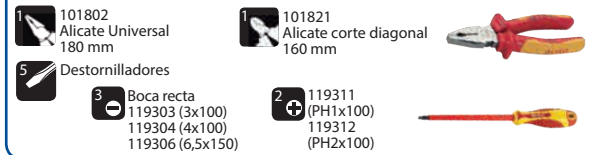

#### Composición 1/2"

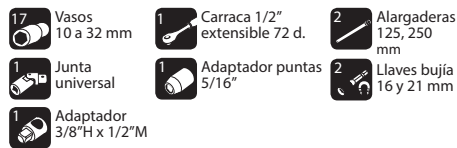

#### Composición 1/4"



#### Composición varios



## Juego de herramienta combinada de 98 piezas



Carraca extensible de 1/2" y 1/4" 5° 72 T

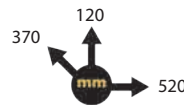

Code	P.V.P. unid. €	
<b>101450</b>	<b>284,78</b>	1

### COMPOSICION NO AISLADA

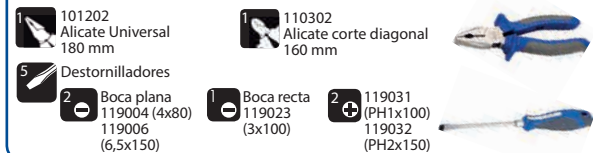

#### Composición 1/2"

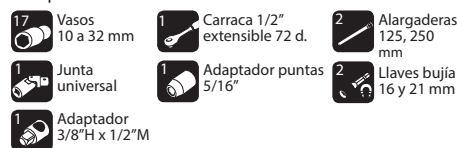

#### Composición 1/4"



#### Composición varios



**Maleta de aluminio reforzada con herramientas**



Cerradura doble



**Maleta 198100**

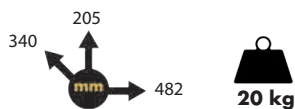

Maleta Maleta + Bolsa

Code	Descripción	Nº Piezas	P.V.P. unid. €
<b>198101</b>	<b>MALETA + COMPOSICIÓN</b>	51	<b>330,00</b>
<b>198106</b>	<b>MALETA + BOLSA + COMPOSICIÓN</b>	52	<b>385,00</b>

Ver características de maleta 198100 en pág. 47 y bolsa 198154 en pág. 49

**Maleta de aluminio de 1 panel con herramientas**



Cerradura doble



**Maleta 198110**

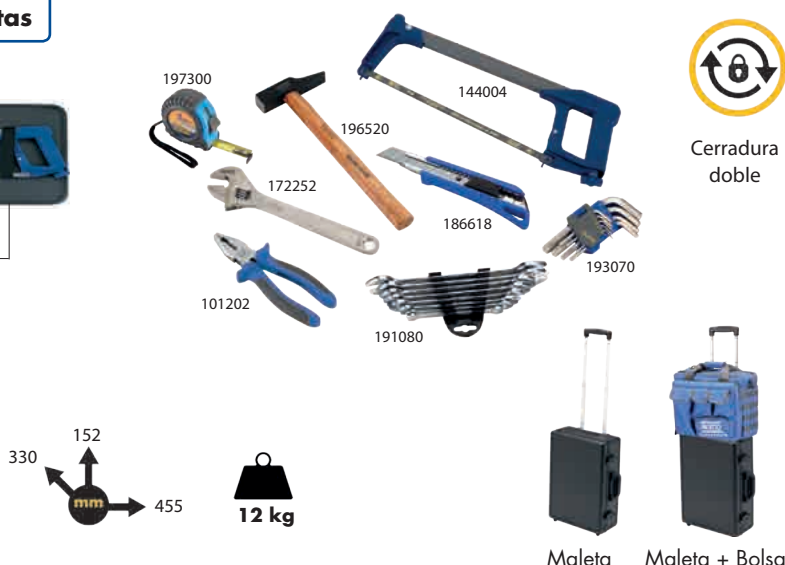

Maleta Maleta + Bolsa

Code	Descripción	Nº Piezas	P.V.P. unid. €
<b>198111</b>	<b>MALETA + COMPOSICIÓN</b>	30	<b>152,00</b>
<b>198116</b>	<b>MALETA + BOLSA + COMPOSICIÓN</b>	31	<b>207,00</b>

Ver características de maleta 198110 en pág. 47 y bolsa 198154 en pág. 49



## 02 Almacenaje



**Carro metálico** 21



**Elemento magnético** 27



**Conjunto de taller** 30



**Mesa de trabajo** 36

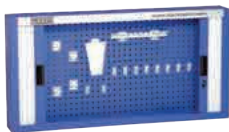

**Armario panel** 38



**Caja metálica** 40



**Carro modular** 42



**Caja de plástico** 44



**Organizador** 45



**Maleta de aluminio** 46



**Bolsa y trolley** 48



**Bolsa de nylon** 52

**Carro metálico reforzado de 7 cajones**



**SISTEMA ANTIVUELCO**  
 Cuando hay un cajón abierto no se puede abrir ningún otro, para evitar el vuelco del carro.



Bandeja Superior Acero Inoxidable

- Chapa de 1 mm de acero tratamiento anti-corrosión
- Freno con posibilidad de bloqueo total en dos de las ruedas. Dos ruedas giratorias y dos fijas
- Cierre de todos los cajones con cerradura centralizada
- Tiradores de los cajones fabricados en aluminio
- Rodamientos a bolas en las guías de los cajones

CAJONES	Medida mm	Peso admisible Kg
5 cajones	570x410x75	<b>25</b>
2 cajones	570x410x155	<b>30</b>

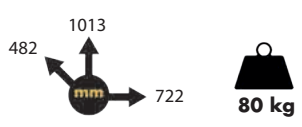

Tras los desplazamientos, pisar el freno



Cerradura centralizada



Carga máxima **400 kg**



Ruedas Ø 5" x 2"

**ACCESORIOS INCLUIDOS:**



Asa reforzada



Bandeja metálica



Portadocumentos metálico



Soporte rollo papel



Papelera metálica



Code	P.V.P. unid. €	
<b>192825</b>	<b>747,00</b>	<b>1</b>

## Carro metálico de 7 cajones

**Nuevo**

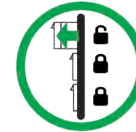

**SISTEMA ANTIVUELCO**  
Cuando hay un cajón abierto no se puede abrir ningún otro, para evitar el vuelco del carro.



Cerradura centralizada

**300 kg**

Carga máxima



Ruedas Ø 5" x 2"

- Chapa de 0,8 mm de acero con tratamiento anti-corrosión
- Bandeja superior en plástico moldeado con alojamientos
- Freno con posibilidad de bloqueo total en dos de las ruedas. Dos ruedas giratorias y dos fijas
- Cierre de todos los cajones con cerradura centralizada
- Tiradores de los cajones fabricados en aluminio
- Rodamientos a bolas en las guías de los cajones



Tras los desplazamientos, pisar el freno

CAJONES	Medida mm	Peso admisible Kg
6 cajones	570x410x75	<b>20</b>
1 cajones	570x410x155	<b>30</b>

Code	P.V.P. unid. €	
<b>129725</b>	<b>595,00</b>	1

## Banco móvil de trabajo

**Nuevo**



Cerradura centralizada

**400 kg**

Carga máxima



Ruedas Ø 5" x 2"

- Chapa de 0,8 mm de acero con tratamiento anti-corrosión
- Caucho protector en la bandeja superior y en la base de los cajones
- Freno con posibilidad de bloqueo total en dos de las ruedas. Dos ruedas giratorias y dos fijas
- Cierre de todos los cajones con cerradura centralizada
- Tiradores de los cajones fabricados en aluminio
- Rodamientos a bolas en las correderas de los cajones



• Tras los desplazamientos, pisar el freno  
• No abrir dos cajones a la vez, por riesgo de vuelco

Code	P.V.P. unid. €	
<b>192678</b>	<b>930,50</b>	1



**Carro metálico de 7 cajones**

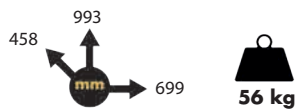

Cerradura centralizada



**300 kg**

Carga máxima



Ruedas Ø 5" x 2"

- Chapa de 0,8 mm de acero con tratamiento anti-corrosión
- Caucho protector en la bandeja superior y en la base de los cajones
- Freno con posibilidad de bloqueo total en dos de las ruedas. Dos ruedas giratorias y dos fijas
- Cierre de todos los cajones con cerradura centralizada
- Tiradores de los cajones fabricados en aluminio
- Rodamientos a bolas en las guías de los cajones



- Tras los desplazamientos, pisar el freno
- No abrir dos cajones a la vez, por riesgo de vuelco

CAJONES	Medida mm	Peso admisible Kg
5 cajones	570x410x75	<b>20</b>
2 cajones	570x410x155	<b>30</b>

Code	P.V.P. unid. €	
<b>192710</b>	<b>490,00</b>	1

**Carro metálico ancho de 7 cajones**

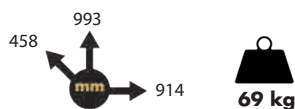

Cerradura centralizada



**350 kg**

Carga máxima



Ruedas Ø 5" x 2"

- Chapa de 0,8 mm de acero con tratamiento anti-corrosión
- Caucho protector en la bandeja superior y en la base de los cajones
- Freno con posibilidad de bloqueo total en dos de las ruedas. Dos ruedas giratorias y dos fijas
- Cierre de todos los cajones con cerradura centralizada
- Tiradores de los cajones fabricados en aluminio
- Rodamientos a bolas en las guías de los cajones



- Tras los desplazamientos, pisar el freno
- No abrir nunca dos cajones a la vez, por riesgo de vuelco

CAJONES	Medida mm	Peso admisible Kg
5 cajones	821x410x75	<b>20</b>
2 cajones	821x410x155	<b>30</b>

Code	P.V.P. unid. €	
<b>192815</b>	<b>697,50</b>	1

## Carro metálico 8 cajones

**Nuevo**



Cerradura centralizada

**300 kg**

Carga máxima



Ruedas Ø 5" x 2"



• Mismas características que el carro 192710, excepto en número de cajones



**Nuevo**



• Tras los desplazamientos, pisar el freno  
• No abrir dos cajones a la vez, por riesgo de vuelco

CAJONES	Medida mm	Peso admisible Kg
7 cajones	570x410x75	20
1 cajón	570x410x155	30

Code	P.V.P. unid. €	
129715	515,00	1

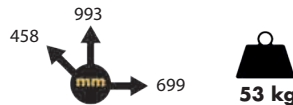

CAJONES	Medida mm	Peso admisible Kg
2 cajones	570x410x75	20
2 cajones	570x410x155	30
1 cajón inferior	570x410x235	40

Code	P.V.P. unid. €	
129720	479,00	1

## Carro de taller ligero con apertura superior



Instrucciones de montaje



Cerradura centralizada

**150 kg**

Carga máxima



Ruedas Ø 4" x 1"

• Tapas superiores correderas  
• Cerradura con llave para cajones y tapa  
• Guías de los cajones con rodamientos a bolas  
• Freno con posibilidad de bloqueo en dos de las ruedas. Dos ruedas fijas y dos giratorias

CAJONES	Medida mm	Peso admisible Kg
Bandeja superior	700x365x170	35
2 cajones	587x325x60	10
Bandeja inferior	700x365x85	35

Code	P.V.P. unid. €	
192780	281,00	1

Se suministra desmontado

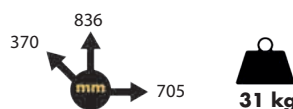

**Carro de taller reforzado**



**200 kg**



Carga máxima

Ruedas Ø 4" x 1"



Instrucciones de montaje

- Estructura reforzada
- Freno con posibilidad de bloqueo en dos de las ruedas.
- Dos ruedas giratorias y dos fijas
- Asa lateral reforzada

Code	P.V.P. unid. €	
<b>192832</b>	<b>192,60</b>	1

Se suministra desmontado

**Carro de taller ligero con 1 cajón**



Cerradura centralizada

**140 kg**

Carga máxima



Ruedas Ø 4" x 1"



- Cajón con guías a rodamiento de bolas
- Freno con posibilidad de bloqueo en dos de las ruedas.
- Dos ruedas giratorias y dos fijas
- Asa lateral reforzada

Code	P.V.P. unid. €	
<b>192727</b>	<b>197,10</b>	1

Se suministra desmontado

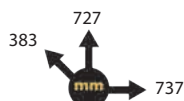

Instrucciones de montaje

**Carro de taller de 3 bandejas**

**100 kg**



Carga máxima

Ruedas Ø 4" x 1"



- Asa para fácil manejo del carro
- Freno con posibilidad de bloqueo en dos de las ruedas.
- Dos ruedas giratorias y dos fijas

Code	P.V.P. unid. €	
<b>192725</b>	<b>103,50</b>	1

Se suministra desmontado

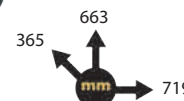

Instrucciones de montaje

## Guías para cajones



**VÁLIDO PARA CARROS  
129715, 129720,  
192710, 192678**

- Guías de rodamiento de bola
- Medidas 400x45 mm
- 1 guía de parte derecha y 1 guía de parte izquierda

Code	P.V.P. unid. €	
<b>190610</b>	<b>14,00</b>	1

**Precio por par de guías**

## Ruedas para carros

Code	Tipo	Medida "	Para carros
190620	FIJA	Ø 4X1	192780, 192832, 192727, 192725
190621	MOVIL CON FRENO	Ø 4X1	192780, 192832, 192727, 192725
190622	FIJA	Ø 5X2	192825, 192725, 192678, 192710, 192815, 129715, 129720
190623	MOVIL CON FRENO	Ø 5X2	192825, 192725, 192678, 192710, 192815, 129715, 129720



190620



190621



190622



190623

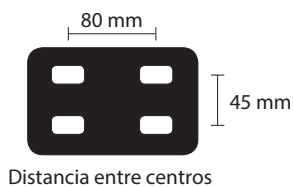

- Estructura metálica
- Ruedas de poliuretano con rodamientos de agujas
- Incluidos 4 tornillos para montaje

Code	Tipo	P.V.P. unid. €	
<b>190620</b>	<b>FIJA</b>	<b>12,00</b>	1
<b>190621</b>	<b>MOVIL</b>	<b>19,00</b>	1
<b>190622</b>	<b>FIJA</b>	<b>22,00</b>	1
<b>190623</b>	<b>MOVIL</b>	<b>31,00</b>	1

## Cerradura para carros con llaves



- Cerradura metálica fácilmente montable
- Conjunto de 2 llaves y bombín

Code	Para carros	P.V.P. unid. €	
<b>190615</b>	192825, 129725, 192678, 192710, 192815, 129715, 129720	<b>7,00</b>	1
<b>190616</b>	Mesa de trabajo 129750, 129755	<b>7,00</b>	1
<b>190617</b>	Mesa de trabajo 192675, 192676, 192677	<b>7,00</b>	1
<b>190618</b>	Arcón 129705	<b>7,00</b>	1
<b>190611</b>	Carrito 192727	<b>7,00</b>	1
<b>190612</b>	192780	<b>7,00</b>	1
<b>190619</b>	Armario de conjunto 192854	<b>7,00</b>	1
<b>190614</b>	Armario 192831, 192851, 192852, 192856	<b>7,00</b>	1

## Divisor para cajones



192699



192604

### POSIBILIDADES DE DIVISORES

Code	Para carro	Piezas
192699	192825 / 129725 192710 / 129715 129720	4 chapas 565x40 mm 6 chapas 403x40 mm
192604	192815	4 chapas 565x40 mm 9 chapas 780x40 mm

• Separadores metálicos. Chapa 1 mm

Code	Nº Piezas	P.V.P. unid. €
<b>192699</b>	10	<b>22,00</b>
<b>192604</b>	13	<b>30,00</b>

## Plato magnético rectangular

ACERO  
INOX



1000  
gauss



Se suministra en blister



- Medida 237x163 mm
- Profundidad plato 28 cm
- 2 Bases magnéticas Ø 80 mm
- Base de PVC para evitar rayado

Code	P.V.P. unid. €	
<b>121510</b>	<b>8,00</b>	1

## Plato magnético redondo

ACERO  
INOX



1000  
gauss



- Diámetro del plato 150 mm
- Profundidad plato 25 cm
- Ø Iman 80 mm
- Base de PVC para evitar rayado

Code	P.V.P. unid. €	
<b>121500</b>	<b>4,50</b>	1

Se suministra en blister

## Plato magnético profundo



800  
gauss



**Nuevo**

- Recipiente de plástico
- Diámetro exterior 109 mm
- Profundidad plato 78 mm
- Ø Iman 60 mm
- Base de PVC para evitar rayado

Code	P.V.P. unid. €	
<b>121502</b>	<b>4,80</b>	1

## Bandeja magnética



**Nuevo**

- Bandeja metálica de 310x110x120 mm
- 4 imanes de alta potencia
- Capacidad de carga 1,20 kg

Code	P.V.P. unid. €	
<b>121560</b>	<b>8,50</b>	1

## Soporte magnético para sprays y destornilladores



**Nuevo**

- Bandeja metálica de 119x300x126 mm
- 8 imanes de alta potencia
- Orificios para 7 destornilladores
- Espacio para 3 sprays de Ø 76 mm
- Capacidad de carga 1,20 kg

Code	P.V.P. unid. €	
<b>121566</b>	<b>12,80</b>	1

## Soporte magnético para destornilladores



**Nuevo**

- Soporte metálico de 240x48x28 mm
- 3 imanes de alta potencia
- Orificios para 9 destornilladores

Code	P.V.P. unid. €	
<b>121562</b>	<b>6,80</b>	1

## Soporte magnético para llaves

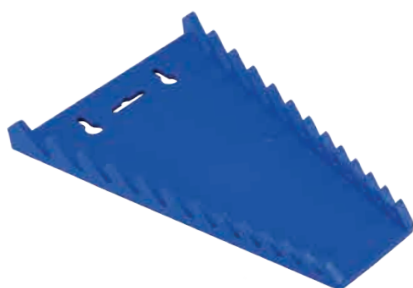

**Nuevo**

- Soporte metálico de 229x150(65)x24 mm
- Imán en la parte posterior
- Orificios para colgar
- Para uso con llaves desde 6 a 24 mm

Code	P.V.P. unid. €	
<b>121564</b>	<b>5,50</b>	1

## Soporte magnético para rollos de papel



**Nuevo**

- Par de soportes metálicos
- Dimensiones: 102x130x83 mm
- Capacidad de 0,64 kg

Code	P.V.P. unid. €	
<b>121568</b>	<b>9,40</b>	1

**Soporte magnético**



121518

121524

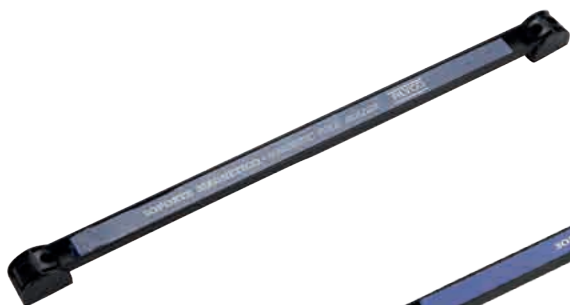

Accesorio para unir soportes magnéticos (se incluyen 2 en 121518)



- Con agujero en cada extremo para sujeción
- Tornillos incluidos
- Para organizar, sujetar y exponer todo tipo de herramientas

Code	L mm	Carga kg	P.V.P. unid. €	
<b>121518</b>	450	13	<b>8,30</b>	1
<b>121524</b>	600	17	<b>9,90</b>	1

Se suministra en blister

**Nuevo**

**Gancho magnético grande**



- Soporte magnético con gancho atornillado
- Ø 64 mm
- Capacidad de carga 11 kg

Code	P.V.P. unid. €	
<b>121572</b>	<b>2,80</b>	1

Se suministra en blister

**Nuevo**

**Juego de 2 ganchos magnéticos**



- Soporte magnético con gancho atornillado
- Ø 50 mm
- Capacidad de carga 6 kg cada uno

Code	P.V.P. unid. €	
<b>121570</b>	<b>2,50</b>	1

Se suministra blister con 2 ganchos

**Nuevo**

**Banda magnética para muñeca**



- Banda regulable con velcro
- Imán de 45x22 mm
- Útil para pequeñas herramientas, clavos, tuercas, tornillos ...

Code	P.V.P. unid. €	
<b>121535</b>	<b>2,60</b>	1

Se suministra en blister

Conjunto de taller de 8 módulos



### COMPOSICIÓN

1 armario alto 192852  
 1 armario alto 192851  
 1 conjunto esquinero 192841 ó 192837  
 4 armarios superiores 192848  
 1 armario base multifunción 192858  
 2 armarios base de 5 cajones 192854  
 1 armario base de 2 puertas 192856  
 4 paneles perforados 192846  
 2 bases de trabajo 192863 ó 192873  
 4 pilares de unión 192865



**Instrucciones  
de montaje**

### COMPLEMENTOS

Baldas de armario  
 Ganchos para panel  
 Accesorios magnéticos  
 Divisores para cajones  
 Cerraduras y llaves  
 Guías para cajones



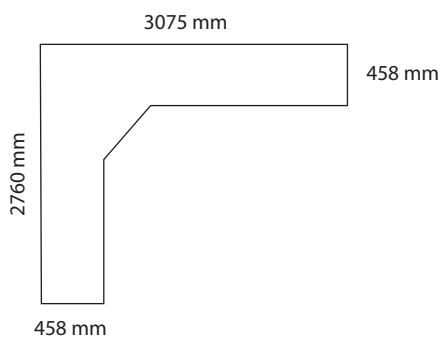

**BASE DE TRABAJO INCLUIDA**

**Madera**



**Acero Inox**



- Espesor de chapa 0,8 mm
- Sistema modular innovador adaptable a sus necesidades
- Montaje rápido y sencillo
- Posibilidad de combinaciones sin límite
- Posibilidad de superficie de trabajo en madera y acero inoxidable
- Los componentes se pueden vender separadamente

Code	Material base	P.V.P. unid. €
<b>192839</b>	<b>MADERA</b>	<b>4.616,00</b>
<b>192838</b>	<b>ACERO INOX</b>	<b>4.758,00</b>

## Conjunto de taller modular 4 módulos



### COMPOSICIÓN

- 1 armario alto 192852
- 3 armarios superiores 192848
- 1 armario base multifunción 192858
- 1 armario base de 5 cajones 192854
- 1 armario base de 2 puertas 192856
- 3 paneles perforados 192846
- 1 base de trabajo 192862 ó 192872
- 3 pilares de unión 192865
- 1 pilar exterior de unión 192864



Instrucciones de montaje

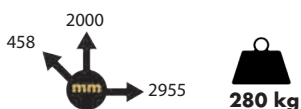

### COMPLEMENTOS

- Baldas de armario
- Ganchos para panel
- Accesorios magnéticos
- Divisores para cajones
- Cerraduras y llaves
- Guías para cajones

- Espesor de chapa 0,8 mm
- Sistema modular innovador adaptable a sus necesidades
- Montaje rápido y sencillo
- Posibilidad de combinaciones sin límite
- Posibilidad de superficie de trabajo en madera y acero inoxidable
- Los componentes se pueden vender separadamente

### BASE DE TRABAJO INCLUIDA

Madera



Acero Inox



Code	Material base	P.V.P. unid. €
192842	MADERA	2.395,00
192843	ACERO INOX	2.440,00

**Conjunto de taller modular 3 módulos**



**COMPOSICIÓN**

- 1 armario alto 192852
- 2 armarios superiores 192848
- 1 armario base de 5 cajones 192854
- 1 armario base de 2 puertas 192856
- 2 paneles perforados 192846
- 1 base de trabajo 192863 ó 192873
- 2 pilares de unión 192865
- 1 pilar exterior de unión 192864



**Instrucciones de montaje**

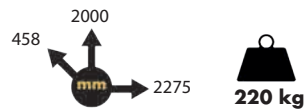

**COMPLEMENTOS**

- Baldas de armario
- Ganchos para panel
- Accesorios magnéticos
- Divisores para cajones
- Cerraduras y llaves
- Guías para cajones

- Espesor de chapa 0,8 mm
- Sistema modular innovador adaptable a sus necesidades
- Montaje rápido y sencillo
- Posibilidad de combinaciones sin límite
- Posibilidad de superficie de trabajo en madera y acero inoxidable
- Los componentes se pueden vender separadamente

**BASE DE TRABAJO INCLUIDA**

**Madera**



**Acero Inox**



Code	Material base	P.V.P. unid. €
<b>192844</b>	<b>MADERA</b>	<b>1.760,00</b>
<b>192845</b>	<b>ACERO INOX</b>	<b>1.790,00</b>

## Armario alto con puerta doble



Cerradura

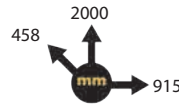

78 kg



Instrucciones de montaje

- Chapa de acero de 0,8 mm
- Incluye 4 baldas

Code	P.V.P. unid. €
------	----------------

**192852 644,00**

**Se suministra desmontado**

Code		P.V.P. unid. €
------	--	----------------

**192853 BALDA 40,00**

## Armario alto con puerta simple



Cerradura

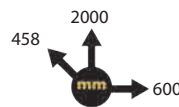

56 kg



Instrucciones de montaje

- Chapa de acero de 0,8 mm
- Incluye 4 baldas

Code	P.V.P. unid. €
------	----------------

**192851 445,00**

**Se suministra desmontado**

Code		P.V.P. unid. €
------	--	----------------

**192849 BALDA 35,00**

## Conjunto esquinero



Cerradura



Instrucciones de montaje

### COMPOSICIÓN

- 1 armario alto
- 1 armario base de 1 puerta
- 2 paneles perforados
- 1 base de trabajo
- 4 pilares

- Chapa de acero de 0,8 mm
- Medidas parte trasera 800x800 mm
- Armarios irregulares de gran capacidad

Code	Material base	P.V.P. unid. €
------	---------------	----------------

**192841 MADERA 942,50**

**192837 ACERO INOX 998,50**

**Se suministra desmontado**

## Conjunto de ganchos para armarios

### COMPOSICIÓN

- 10 ganchos simples
- 2 ganchos dobles
- 2 ganchos en V
- 1 soporte para llaves
- 1 soporte destornilladores

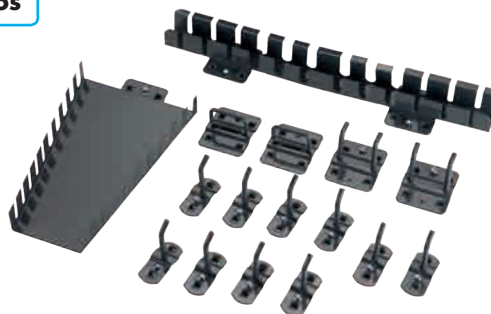

Para cuadrado de panel 10x10 mm

Code	Nº Piezas	P.V.P. unid. €
------	-----------	----------------

**113499 16 32,50**

Para code 192802, 192804, 192806, 192808, 192676 y armarios modulares

## Armario base de 5 cajones



Cerradura



- Estructura de acero de 1 mm
- Chapa de acero de 0,8 mm
- 5 cajones con guías de rodamiento a bolas

Code	P.V.P. unid. €
<b>192854</b>	<b>392,50</b>

## Armario base multifunción

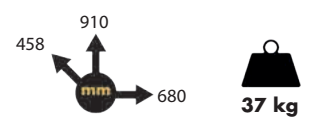

- Estructura de acero de 1 mm
- Con trampilla para cubo de basura
- Con dispositivo para rollo de papel

Code	P.V.P. unid. €
<b>192858</b>	<b>305,60</b>

## Armario superior

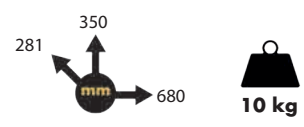

- Estructura en acero de 1 mm
- Puerta con apertura hacia arriba
- Apertura suave por muelles de gas

Code	P.V.P. unid. €
<b>192848</b>	<b>122,70</b>

## Armario base de 2 puertas



Cerradura



- Estructura de acero de 1 mm
- Chapa de acero de 0,8 mm
- Con 2 baldas interiores

Code	P.V.P. unid. €
<b>192856</b>	<b>232,50</b>

## Panel perforado de pared

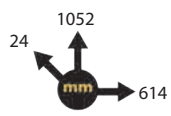
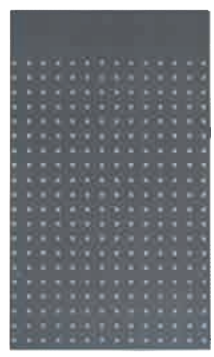

- Chapa en acero perforada
- Cuadrado de panel 10x10 mm
- Ensamblable con pilares

Code	P.V.P. unid. €
<b>192846</b>	<b>88,32</b>

## Pilar

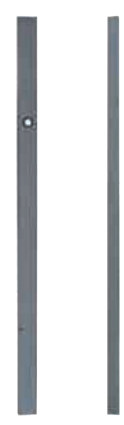

**Nuevo**

- 192865 pilar de unión entre paneles metálicos
- 192864 pilar exterior de unión

Code	L m	P.V.P. unid. €
<b>192865</b>	1	<b>25,00</b>
<b>192864</b>	1	<b>20,00</b>

## Base de trabajo

**Madera**



- Tablero aglomerado de 38 mm
- Lacado especial protector

Code	L m	P.V.P. unid. €
<b>192863</b>	1,42	<b>159,00</b>
<b>192862</b>	2,10	<b>214,00</b>

**Acero inox**



- Placa de 38 mm

Code	L m	P.V.P. unid. €
<b>192873</b>	1,42	<b>185,00</b>
<b>192872</b>	2,10	<b>257,00</b>

## Mesa de trabajo con 2 cajones



Instrucciones de montaje



Cerradura en 2 cajones

**500 kg**

Carga máxima

### PANEL VERTICAL

- Panel en chapa de 1,2 mm
- Zona preparada para la colocación de una luz
- Escuadra de refuerzo en el panel
- Incluye 16 ganchos para colocar herramienta

- Mesa de trabajo en chapa de 2'5 mm
- Funda de caucho protector para la mesa de trabajo
- Balda en la parte inferior de la mesa
- Posibilidad de sujeción al suelo
- Dos cajones con cerradura propia
- Pintado rugoso anticorrosión

Ganchos disponibles ver pág. 34

### INCLUYE:



Funda de caucho protectora



**86 kg**

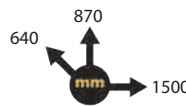

**74 kg**



Instrucciones de montaje

CAJONES	Medida mm	Peso admisible Kg
2 cajones	446x420x100	25

Code	Descripción	P.V.P. unid. €	
192675	MESA SIN PANEL	497,00	1
192676	MESA CON PANEL	626,00	1

Se suministra desmontada

## Mesa de trabajo con 3 cajones



Instrucciones de montaje



Cerradura en 3 cajones

**500 kg**

Carga máxima

CAJONES	Medida mm	Peso admisible Kg
3 cajones	430x450x145	25

- Mesa de trabajo en chapa de 2'5 mm
- Funda de caucho protector para la mesa
- Balda en la parte inferior de la mesa
- Posibilidad de sujeción al suelo

Code	P.V.P. unid. €	
192677	640,00	1

Se suministra desmontada

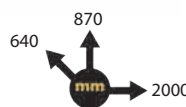

**96 kg**

**Mesa de trabajo con 3 cajones y 2 portones**



Instrucciones de montaje

**Nuevo**

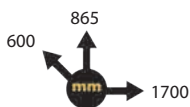

**54 kg**



Cerradura centralizada

**300 kg**

Carga máxima

CAJONES	Medida mm	Peso admisible Kg
3 cajones	444x445x175	<b>30</b>

- Chapa de acero 0,6 mm
- Patas de acero de 2 mm
- 2 cerraduras comunes para cajones y portones
- Encimera de tablero aglomerado de 38 mm
- Estructura modular de montaje rápido
- Apertura completa de los cajones
- Cajones con guías a rodamientos de bolas
- Pies regulables en altura para equilibrado

Code	P.V.P. unid. €
<b>129755</b>	<b>580,00</b>

**Se suministra desmontada**

**Mesa de trabajo con 3 cajones y 1 portón**



Instrucciones de montaje

**Nuevo**

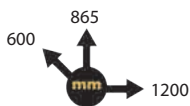

**42 kg**



Cerradura centralizada

**300 kg**

Carga máxima

CAJONES	Medida mm	Peso admisible Kg
3 cajones	444x445x175	<b>30</b>

- Chapa de acero 0,6 mm
- Patas de acero de 2 mm
- 1 cerradura común para cajones y portones
- Encimera de tablero aglomerado de 38 mm
- Estructura modular de montaje rápido
- Apertura completa de los cajones
- Cajones con guías a rodamientos de bolas
- Pies regulables en altura para equilibrado

Code	P.V.P. unid. €
<b>129750</b>	<b>480,00</b>

**Se suministra desmontada**

## Armario con puertas correderas

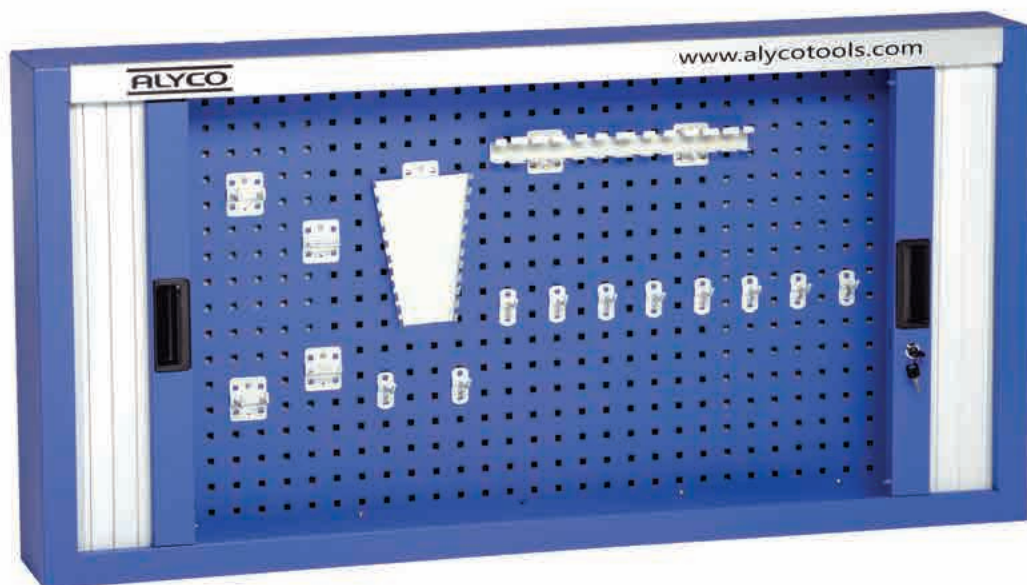

Cerradura

### INCLUYE:



Pack de 16 ganchos **113499**

- Chapa perforada de 1 mm
- Agujeros de panel 10x10 mm
- Persiana con cerradura por llave
- Con orificios atrás para colgar en pared y debajo para colocar sobre la mesa de trabajo

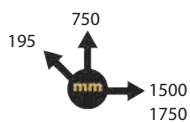

**38 kg**  
**44 kg**

Code	Medida mm	P.V.P. unid. €
<b>192802</b>	1500x750x195	<b>570,00</b>
<b>192804</b>	1750x750x195	<b>645,00</b>

## Panel mural para herramientas

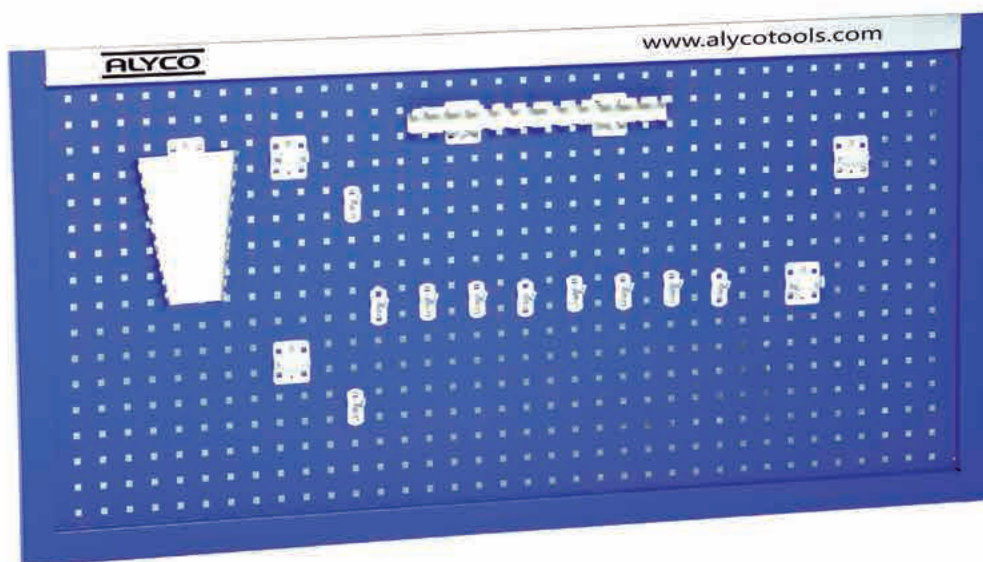

### INCLUYE:



Pack de 16 ganchos **113499**

- Chapa perforada de 1 mm
- Agujeros de panel 10x10 mm
- Preparado para colgar en la pared

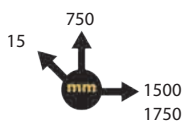

**11 kg**  
**13 kg**

Code	Medida mm	P.V.P. unid. €
<b>192806</b>	1500x750x15	<b>182,00</b>
<b>192808</b>	1750x750x15	<b>214,00</b>



**Nuevo**

## Arcón metálico de 4 cajones

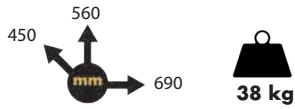

Combinable con carros



Cerradura centralizada

**90 kg**

Carga máxima

CAJONES	Medida mm	Peso admisible Kg
4 cajones	670x400x48	<b>5</b>

- Tapa plegable para cierre y protección de cajones
- Tapa con sistema de apertura con muelles de gas
- Caucho protector en la base de los cajones
- Asa metálica en los laterales

Code	P.V.P. unid. €	
<b>129705</b>	<b>320,40</b>	1

## Baúl para construcción



No incluye herramientas

**192793**



**192792**



- Espesor de chapa: 192792 de 1 mm, 192793 de 1,2 mm
- Presentación pintado rugoso
- Baúl 192793 incluye bandeja metálica interior

Code	Medida mm	Carga máx. kg	P.V.P. unid. €
<b>192792</b>	580 x 280 x 287	40	<b>92,50</b>
<b>192793</b>	685 x 355 x 332	50	<b>149,00</b>

## Conjunto de 2 baules



**COMPOSICION**  
**192792 + 192793**

Code	Medida mm	P.V.P. unid. €
<b>192794</b>	685 x 355 x 332	<b>224,00</b>

## Caja de herramientas metálica, 5 bandejas

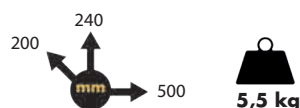

Preparado para candado

**28 kg**

Carga máxima



- Espesor de chapa 0,6 mm
- 4 bandejas de 500x95x50 mm
- 1 bandeja base de 500x200x125 mm
- Pintado electrostático a dos colores. Secado en horno
- Asas abatibles

Code	P.V.P. unid. €	
<b>192735</b>	<b>43,00</b>	1

## Caja de herramientas metálica, 3 bandejas

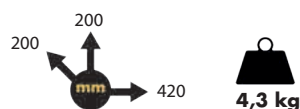

Preparado para candado

**18 kg**

Carga máxima



- Espesor de chapa 0,6 mm
- 2 bandejas de 420x95x50 mm
- 1 bandeja base de 420x200x125 mm
- Pintado electrostático a dos colores. Secado en horno
- Asas abatibles

Code	P.V.P. unid. €	
<b>192731</b>	<b>35,00</b>	1

## Caja de herramientas metálica, 1 bandeja

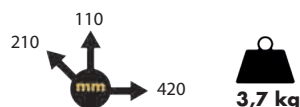

Preparado para candado

**8 kg**

Carga máxima

- Espesor de chapa 0,6 mm
- 1 bandeja base de 420x210x110 mm
- Pintado electrostático a dos colores. Secado en horno
- Asas abatibles

Code	P.V.P. unid. €	
<b>192733</b>	<b>24,00</b>	1

**Caja metálica reforzada**



183352



Preparado para candado



1,5 kg

**15 kg**

Carga máxima



183354



Preparado para candado



2 kg

**18 kg**

Carga máxima



183356



Preparado para candado



3,3 kg

**22 kg**

Carga máxima

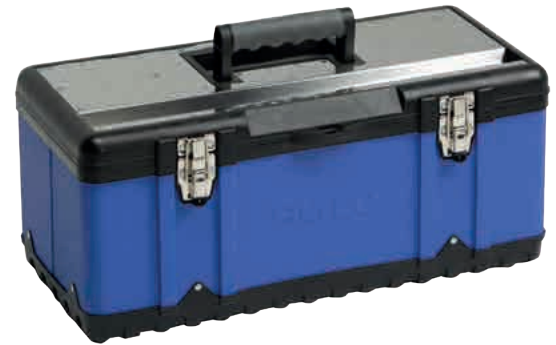

- Caja metálica con refuerzos de plástico
- Chapa plegada de 0,6 mm
- Asa móvil ergonómica
- Cierres metálicos
- Bandeja de plástico extraíble
- Bisagra con pasador metálico
- Protectores antichoque

Code	Medida mm	P.V.P. unid. €	
<b>183352</b>	395x180x170	<b>20,70</b>	1
<b>183354</b>	470x238x203	<b>29,66</b>	1
<b>183356</b>	582x298x255	<b>44,50</b>	1

**Conjunto de cajas metálicas**



**COMPOSICION**  
183352 + 183354 + 183356

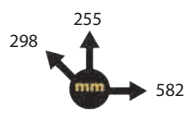

6,9 kg

Code	P.V.P. unid. €	
<b>183350</b>	<b>83,80</b>	1

## Carro metálico modular reforzado



Preparado para candado

**50 kg**

Carga máxima

Espesor de chapa 0,8 mm

Guías de rodamientos a bolas

Módulos fijados por cierres metálicos

Ruedas de goma reforzadas de 5"

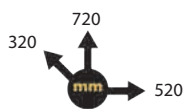

Asa extensible telescópica en aluminio



Asa reforzada de aluminio



### DIMENSIONES

1 caja metálica	580x280x220 mm
1 caja metálica	490x250x220 mm
1 baúl inferior	430x250x430 mm

Code	P.V.P. unid. €	
<b>183310</b>	<b>169,00</b>	1

## Carro metálico modular



Preparado para candado

**50 kg**

Carga máxima

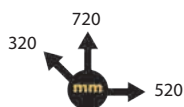

- Carro compuesto por 3 módulos
- Chapa metálica de 0,8 mm
- Módulos fijados por cierres metálicos
- Guías de rodamientos a bolas
- Asa extensible telescópica en aluminio
- Ruedas de goma de 5"

Code	P.V.P. unid. €	
<b>183300</b>	<b>159,00</b>	1

## Baúl de plástico + Caja de plástico



Preparado para candado

**20 kg**

Carga máxima



No incluye herramientas

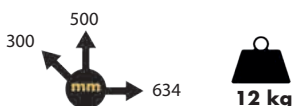

### DIMENSIONES

1 baúl inferior	634x300x279 mm
1 caja plástico	508x256x223 mm

- Carro compuesto por baúl de plástico + caja de plástico con asa de aluminio y cierres metálicos
- Ambos módulos con bandeja interior de plástico
- Caja fijada al baúl de plástico mediante cierres metálicos
- Caja con asa de aluminio y organizador de plástico transparente en la parte superior
- Asa extensible telescópica
- Ruedas de goma de gran tamaño

Code	P.V.P. unid. €	
<b>192796</b>	<b>124,76</b>	1

## Carro de plástico modular



Preparado para candado

**20 kg**

Carga máxima



No incluye herramientas



- Carro modular en plástico de gran resistencia
- Compartimento de carga + 3 cajones + caja de plástico con bandeja interior
- Posibilidad de desmontar en 3 módulos
- Asa extensible telescópica
- Ruedas de goma de gran tamaño

Code	P.V.P. unid. €	
<b>192795</b>	<b>90,82</b>	1

## Baúl de plástico 4 en 1



No incluye herramientas

- Bandeja superior de plástico para herramientas
- Bandeja inferior de plástico para herramientas
- Tapa de plástico con alojamientos recubiertos
- Asa metálica extensible
- Compartimento de carga de gran volumen
- Ruedas de goma para su transporte más fácil

Code	P.V.P. unid. €	
<b>192759</b>	<b>75,06</b>	1

## Caja de plástico con bandejas extraíbles



No incluye herramientas



Cajas extraíbles



192821



192822



192823



192824



Preparado para candado

Cada caja incluye:

- Bandeja de plástico extraíble con divisiones
- Cajas compartimentadas. Dos cajas extraíbles de plástico situadas en la tapa de cada caja
- Asa de plástico ergonómica recubierta de caucho

Code	Medida mm	Capacidad de carga (kg)	P.V.P. unid. €
<b>192821</b>	606x310x300	10	<b>27,40</b>
<b>192822</b>	508x250x240	8	<b>19,60</b>
<b>192823</b>	432x220x180	5	<b>12,20</b>
<b>192824</b>	355x180x140	3	<b>7,10</b>

## Conjunto de 4 cajas de plástico

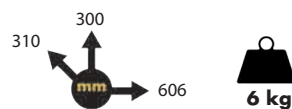

**COMPOSICION**  
192821 + 192822  
192823 + 192824

Code	P.V.P. unid. €	
<b>192765</b>	<b>63,00</b>	1

## Conjunto de 3 cajas de plástico

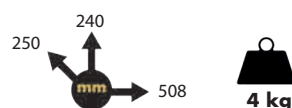

**COMPOSICION**  
192822 + 192823 + 192824

Code	P.V.P. unid. €	
<b>192829</b>	<b>36,00</b>	1

**Caja de plástico reforzada**



Preparado para candado

**8 kg**

Carga máxima



- Asa móvil de aluminio ergonómica
- Cierres metálicos
- Bandeja de plástico extraíble
- Bisagra con pasador metálico
- Protectores antichoque

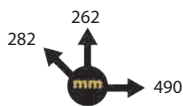

Code	P.V.P. unid. €	
<b>183370</b>	<b>29,90</b>	1

**Caja para consumibles**



Se pueden apilar hasta 7 cajas

- 4 cajones con 4 compartimentos cada uno
- Compartimento superior con tapa de plástico
- Asa de plástico

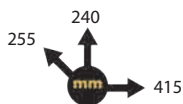

Code	P.V.P. unid. €	
<b>183360</b>	<b>30,40</b>	6

**Organizador doble para consumibles**



No incluye consumibles



- Caja de doble cara con múltiples divisiones en cada una de ellas
- Posibilidad de modificar la estructura interna del organizador moviendo los divisores interiores de plástico
- Con cierres para cada tapa
- Cubiertas transparentes de policarbonato

Code	Medida mm	P.V.P. unid. €	
<b>192766</b>	320x260x80	<b>9,88</b>	5
<b>192768</b>	380x290x80	<b>12,72</b>	5

## Organizador para consumibles



Diseño especial de la tapa que organiza las cajas al ser cerradas

- Asa ergonómica y bimaterial
- Doble cierre lateral de la caja

Code	Compartimentos	P.V.P. unid. €	
<b>192763</b>	8	<b>21,93</b>	5
<b>192762</b>	19	<b>16,87</b>	5
<b>192760</b>	15	<b>8,51</b>	5

No incluye consumibles

## Maleta de aluminio trolley de 4 ruedas



**15 kg**

Carga máxima



Asa telescópica ajustable



Maleta

Maleta+bolsa  
198154

- Estructura metálica con paneles de aluminio
- 2 paneles para herramientas con elásticos para sujeción
- Sistema de sujeción de la bandeja en vertical

Code	Descripción	Medida mm	P.V.P. unid. €
<b>198121</b>	<b>MALETA</b>	455x330x200	<b>140,00</b>
<b>198122</b>	<b>MALETA + BOLSA</b>	1000x330x200	<b>196,00</b>



**Maleta de aluminio reforzada**

Portadocumentos con cierre de cremallera

Bandejas reforzadas para herramientas

Base modular reforzada en plástico ABS. 5 separadores

Ruedas para el transporte

Refuerzos de aluminio



Bandejas con elásticos y bolsillos para la sujeción de herramientas

2 bandejas para herramientas



Cerradura doble

**20 kg**

Carga máxima

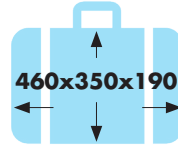

medidas interiores (mm)

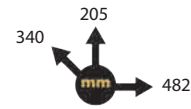

**6 kg**

Asa extensible



Maleta

Maleta+bolsa  
198154

Code	Descripción	Medida mm	P.V.P. unid. €
<b>198100</b>	<b>MALETA</b>	482x340x205	<b>148,00</b>
<b>198105</b>	<b>MALETA + BOLSA</b>	800x340x205	<b>204,00</b>

**Maleta de aluminio de 1 bandeja**



medidas interiores (mm)



Cerradura doble

**15 kg**

Carga máxima

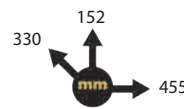

**3,8 kg**

Asa extensible



Maleta

Maleta+bolsa  
198154

- Bandeja para herramientas con elásticos para sujeción
- Sistema de sujeción de la bandeja en vertical
- Base modular con 5 separadores
- Asa extensible y ruedas para transporte

Code	Descripción	Medida mm	P.V.P. unid. €
<b>198110</b>	<b>MALETA</b>	455x330x152	<b>69,00</b>
<b>198115</b>	<b>MALETA + BOLSA</b>	770x330x152	<b>125,00</b>

## Bolsa de nylon con asa metálica

Polyester 600D

Asa metálica con recubrimiento de goma



Cinta para hombro con refuerzo de goma en la zona de contacto con el hombro

Zona exterior de la bolsa con diferentes tipos de bolsillos



**45 kg**

Carga máxima



Zona diseñada para artículos de formas diversas y tamaño reducido. Cierre con cremallera.



Zona diseñada para artículos de mayor tamaño (herramienta eléctrica, baterías, pinturas, etc.) Zona portadocumentos cubierta. Cierre con cremallera.

Code	P.V.P. unid. €	
<b>198160</b>	<b>79,00</b>	1

No incluye herramientas

## Bolsa de nylon con ruedas

Polyester 600D

Asa de nylon reforzada y acolchada



Soportes de plástico en la base para apoyar en el suelo

Zonas frontales y laterales con bolsillos de diferentes tamaños

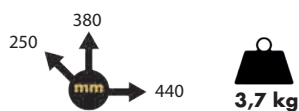

**25 kg**

Carga máxima

Cierre de la bolsa mediante cremallera

Zona interior con bolsillos de diferentes tamaños



Boca reforzada para mantenerse abierta durante el trabajo



Asa de aluminio extensible

Code	P.V.P. unid. €	
<b>198150</b>	<b>67,00</b>	1

No incluye herramientas

**Nuevo**

**Bolsa de nylon con trolley**

Polyester 600D

**20 kg**

Carga máxima

Apertura superior rígida y ancha para fácil acceso



Asas reforzadas acolchadas

Asa telescópica



Herramientas no incluidas

Correa ajustable acolchada para hombro

- Fabricada en nylon resistente
- Costura resistente con borde reforzado
- 6 bolsillos exteriores y 8 interiores
- Cremallera de nylon con apertura fácil
- Asa telescópica y ruedas integradas
- Base rígida de plástico impermeable
- Lazos laterales ajustables para transporte de herramientas largas
- Clip metálico exterior para flexómetro

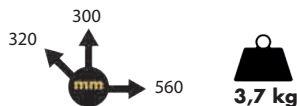

Code	P.V.P. unid. €	
<b>198132</b>	<b>76,50</b>	1

**Bolsa de nylon para portátil y herramientas**

Polyester 600D

**30 kg**

Carga máxima

Alojamiento para ordenador de hasta 12"



Cinta para hombro con refuerzo de goma en la zona de contacto con el hombro

Alojamientos interiores para diversas herramientas

4 bolsillos exteriores

Zona exterior de la bolsa con diferentes tipos de bolsillos

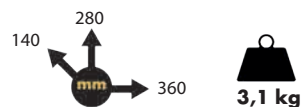

Code	P.V.P. unid. €	
<b>198154</b>	<b>58,00</b>	1

No incluye herramientas

## Mochila de nylon con panel interior

Polyester 600D

Asa de nylon reforzada y acolchada

30 kg

Carga máxima

Zona interior con bolsillos de diferentes tamaños

Cierre de la bolsa mediante cremallera

Panel rígido con 56 alojamientos

Cinta reflectora

Base reforzada de plástico duro para apoyar en el suelo

Zonas frontales y laterales con bolsillos de diferentes tamaños

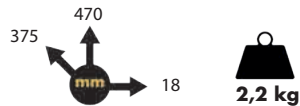

Code	P.V.P. unid. €	
198152	69,50	1

No incluye herramientas

## Trolley de nylon

Polyester 600D

Asa telescópica con 2 posiciones de extensión

20 kg

Carga máxima

Preparado para candado

Gran bolsillo interior apto para ordenador

Departamento superior para herramientas pequeñas y documentos

2 lazos laterales ajustables para transporte de herramientas largas

Panel interior extraíble con múltiples compartimentos

2 líneas de lazos frontales

- Fabricada en nylon resistente
- Cremallera de nylon con apertura fácil
- Base rígida de plástico impermeable

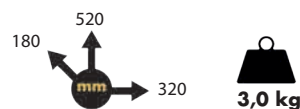

Code	P.V.P. unid. €	
198135	99,00	1

No incluye herramientas

**Nuevo**

**Mochila de nylon**

Polyester 600D



Asa de nylon reforzada y acolchada

Tiras de hombro ajustables y acolchadas

3 bolsillos frontales y 2 laterales

**15 kg**

Carga máxima

Herramientas no incluidas

**Nuevo**



Compartimento para ordenador

Compartimento para documentación

10 bolsillos de diferentes tamaños

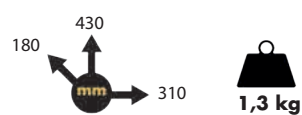

- Fabricada en nylon resistente
- Cremallera de nylon con apertura fácil
- Base rígida de plástico impermeable

Code	P.V.P. unid. €	
<b>198134</b>	<b>48,00</b>	1

**Bolsa de nylon**

Polyester 600D



Asas reforzadas con cierre plástico

Correa ajustable acolchada para hombro

**20 kg**

Carga máxima

**Nuevo**

Apertura superior rígida y ancha para fácil acceso



Herramientas no incluidas



- Fabricada en nylon resistente
- Costura resistente con borde reforzado
- 10 bolsillos exteriores y 10 interiores
- Panel rígido interior extraíble para reforzar el fondo
- Cremallera de nylon con apertura fácil
- Base de plástico impermeable
- Clip metálico exterior para flexómetro

Code	P.V.P. unid. €	
<b>198130</b>	<b>49,80</b>	1

**Bolsa de nylon**

Polyester 600D



Asas reforzadas acolchadas

Correa ajustable acolchada para hombro

**15 kg**

Carga máxima

**Nuevo**

Apertura superior rígida y ancha para fácil acceso



Herramientas no incluidas

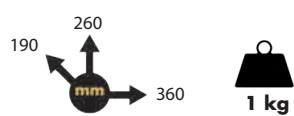

- Fabricada en nylon resistente
- Costura resistente con borde reforzado
- 6 bolsillos exteriores y 6 interiores
- Cremallera de nylon con apertura fácil
- Base de plástico impermeable
- Clip metálico exterior para flexómetro

Code	P.V.P. unid. €	
<b>198125</b>	<b>28,00</b>	1

## Bolsa de nylon

Polyester  
600D

Zona exterior  
con diferentes  
tipos de bolsillos



Alojamientos interiores  
para diversas herramientas

Cierre principal  
con velcro

Cinta para hombro acolchada



Posibilidad de sujeción  
al hombro y la cintura

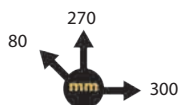

0,7 kg

Code	P.V.P. unid. €	
196860	30,50	1

## Bolsa nylon para cinturón

Refuerzo de nylon acolchado

Polyester  
600D

Bolsillo de gran tamaño

Cinturón de nylon  
ajustable con  
cierre rápido

Bolsillo acolchado  
para material delicado



Posibilidad de sujeción a bolsillo y cinturón

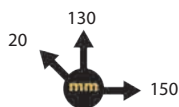

0,3 kg

Code	P.V.P. unid. €	
196850	9,10	1

## Bolsa de nylon para construcción

Polyester  
600D

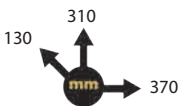

0,5 kg

- Tejido de nylon con refuerzos interiores
- Cinturón de nylon ajustable
- Cierre rápido

Code	P.V.P. unid. €	
196872	22,20	1

**Bolsa de nylon para herramienta electroportátil**

Polyester  
600D

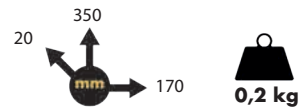

- Cinturón de nylon ajustable con cierre rápido
- Correa con cierre rápido para la sujeción de la herramienta electroportátil

Code	P.V.P. unid. €	
<b>196852</b>	<b>11,30</b>	1

**Bolsa de nylon**



196880



196882

- Fabricada en nylon con refuerzos interiores
- Cinturón de nylon ajustable
- Cierre rápido

Code	Medida mm	P.V.P. unid. €
<b>196880</b>	240x240x55	<b>15,90</b>
<b>196882</b>	170x240x55	<b>14,50</b>

**Bolsa de nylon individual**

Polyester  
600D

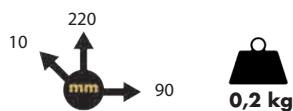

Posibilidad de sujeción al bolsillo y al cinturón

Code	P.V.P. unid. €	
<b>196848</b>	<b>4,50</b>	1



## 03 Alicates y cortantes



**Alicate de alta potencia** 55



**Alicate de corte y manipulación** 56



**Alicate de corte** 57



**Tenacilla** 58



**Alicate aislado** 59



**Alicate para arandelas** 62



**Tenaza grip** 63



**Mini alicate** 64



**Tenaza rusa** 66



**Cortabulón** 68



**Cortacables** 69



**Pelacables** 70



**Prensaterminales** 72



**Tijera** 74



**Navaja** 76



**Tijera cortachapas** 79



**Alicate universal de alta potencia**

DIN 5746

**Alta potencia**

ACERO CR-V

Filo de corte templado por inducción hasta HRC 62

Mango bimaterial ergonómico más grueso



Presentación pulido y lacado

**45% MENOR ESFUERZO**

CAPACIDAD DE CORTE ALAMBRE	
	Ø mm
	101206/ 101208/ 101209
○	<b>4/5/6</b>
◐	<b>2,8/3,5/4</b>
◑	<b>1,8/2,4/2,8</b>
●	<b>1,6/2/2,4</b>

Code	L mm	L "	P.V.P. unid. €	
<b>101206</b>	180	7	<b>17,42</b>	6
<b>101208</b>	200	8	<b>22,00</b>	5
<b>101209</b>	225	9	<b>23,00</b>	5

Se suministra con colgador

**PRINCIPIO DE ALTA POTENCIA**

Reducción del esfuerzo hasta un **45% tanto en las operaciones de corte como en las de manipulación (sujetar, doblar, estirar).**

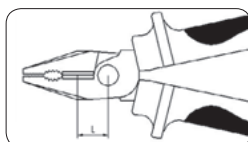

Distancia menor entre el eje de giro y el filo de corte debido a la unión excéntrica del remache.

**DISTANCIA EJE-FILO ALICATE UNIVERSAL**

L mm	Alta potencia	Standard
	<b>14</b>	<b>20</b>

**Alicate de corte diagonal**

DIN 5749

**Alta potencia**

ACERO CR-V



CAPACIDAD DE CORTE	
Alambre	Ø mm
	110304 110305
○	<b>4</b>
◐	<b>3</b>
◑	<b>2</b>
●	<b>1,6</b>

Code	L mm	L "	P.V.P. unid. €	
<b>110304</b>	160	6	<b>17,50</b>	6
<b>110305</b>	180	7	<b>21,00</b>	5

Se suministra con colgador

**Alicate de corte diagonal reforzado**

DIN 5749

**Alta potencia**

ACERO CR-V



CAPACIDAD DE CORTE	
Alambre	Ø mm
	101312
○	<b>5</b>
◐	<b>3,5</b>
◑	<b>2,4</b>
●	<b>2</b>

Code	L mm	L "	P.V.P. unid. €	
<b>101312</b>	200	8	<b>22,00</b>	5

Se suministra con colgador

**Alicate de puntas semirredondas recto con corte**

DIN 5745

**Alta potencia**

ACERO CR-V



Code	L mm	L "	P.V.P. unid. €	
<b>101303</b>	160	6	<b>17,50</b>	6
<b>101304</b>	200	8	<b>21,00</b>	5

Se suministra con colgador

ALAMBRE DE CORTE: ○ Blando / ◐ Semiduro / ◑ Duro / ● Cuerda piano

## Alicate universal

DIN  
5746

ACERO  
CR-V



### CAPACIDAD DE CORTE

	Ø mm 101201/ 101202/ 101203
○	4/4/4
◐	2,8/3/3
◑	1,8/2/2
●	1,4/1,6/1,6

- Filos de corte templados por inducción
- Terminación pulido y lacado (antióxido)
- Mangos bimateriales y ergonómicos

Code	L mm	L "	P.V.P. unid. €	
<b>101200</b>	130	5	<b>10,50</b>	6
<b>101201</b>	160	6	<b>11,50</b>	6
<b>101202</b>	180	7	<b>12,50</b>	6
<b>101203</b>	200	8	<b>13,50</b>	6

Se suministra con colgador

## Alicate de puntas semirredondas con corte

DIN  
5745

ACERO  
CR-V



Code	L mm	L "	P.V.P. unid. €	
<b>101300</b>	140	5,5	<b>11,50</b>	6
<b>101301</b>	160	6	<b>11,90</b>	6
<b>101302</b>	200	8	<b>13,80</b>	6

Se suministra con colgador

## Alicate de puntas semirredondas boca curva

DIN  
5745

ACERO  
CR-V



Code	L mm	L "	P.V.P. unid. €	
<b>101310</b>	200	8	<b>14,80</b>	6

Se suministra con colgador

## Alicate de bocas planas

DIN  
5745

ACERO  
CR-V



Code	L mm	L "	P.V.P. unid. €	
<b>102201</b>	160	6	<b>11,50</b>	6

Se suministra con colgador

## Alicate de puntas redondas

DIN  
5745

ACERO  
CR-V



Code	L mm	L "	P.V.P. unid. €	
<b>104101</b>	160	6	<b>12,50</b>	6

Se suministra con colgador

## Alicate pelacables

ACERO  
CR-V



- Con tornillo para regular al diámetro del cable

Code	L mm	L "	P.V.P. unid. €	
<b>107101</b>	160	6	<b>17,28</b>	6

Se suministra con colgador

ALAMBRE DE CORTE: ○ Blando / ◐ Semiduro / ◑ Duro / ● Cuerda piano

**Alicate de corte diagonal**

DIN  
5749

ACERO  
CR-V

**CAPACIDAD DE CORTE**

Alambre	Ø mm
	110302 110303
○	4
◐	3
◑	2
●	1,6



- Filos de corte templados por inducción
- Terminación pulido y lacado (antioxido)
- Mangos bimateriales y ergonómicos

Code	L mm	L "	P.V.P. unid. €	
<b>110301</b>	130	5,5	<b>11,00</b>	6
<b>110302</b>	160	6	<b>11,50</b>	6
<b>110303</b>	180	8	<b>12,50</b>	6

Se suministra con colgador

**Alicate de corte diagonal reforzado**

DIN  
5749

ACERO  
CR-V

**CAPACIDAD DE CORTE**

Alambre	Ø mm
	110310/ 110311
○	5
◐	3,5
◑	2,4
●	2



Code	L mm	L "	P.V.P. unid. €	
<b>110309</b>	160	6	<b>12,50</b>	6
<b>110310</b>	180	7	<b>13,50</b>	6
<b>110311</b>	200	8	<b>15,00</b>	6

Se suministra con colgador

**Juego de alicates en caja de plástico**

**Alta potencia**



Medida caja: 255x185x48 mm

**COMPOSICION** 101206 / 110305 / 101304

Code	Nº Piezas	P.V.P. unid. €	
<b>101217</b>	3	<b>58,50</b>	1

**Alicate de corte frontal**

DIN  
5748

ACERO  
CR-V

**CAPACIDAD DE CORTE**

Alambre	Ø mm
	111100 /111101
○	4/5
◐	3/3,5
◑	2/2,4
●	1,6/2



Code	L mm	L "	P.V.P. unid. €	
<b>111100</b>	160	6	<b>14,00</b>	6
<b>111101</b>	200	8	<b>16,80</b>	6

Se suministra con colgador

**Juego de alicates en caja de plástico**



Medida caja: 255x185x48 mm

**COMPOSICION** 101202 / 110303 / 101302

Code	Nº Piezas	P.V.P. unid. €	
<b>101210</b>	3	<b>38,90</b>	1

**ALAMBRE DE CORTE:** ○ Blando / ◐ Semiduro / ◑ Duro / ● Cuerda piano

## Tenacilla de ajuste automático

ACERO  
CR-V-MO



**Ajuste con una sola mano  
sin pulsar ningún botón**

- Dentado de las mordazas templado (60 HRC)
- Grosor de las bocas 12 mm. Permite una gran fuerza de apriete (muy superior a las tenacillas estándar)
- Terminación: pavonado, bocas pulidas.
- Mangos recubiertos en PVC

Code	L mm	L "	Capac. max ∅ mm	P.V.P. unid. €	
<b>115140</b>	240	9,5	42	<b>28,00</b>	6

Se suministra con colgador

## Tenacilla de ajuste rápido

ACERO  
CR-V



- Dentado templado por alta frecuencia (HRC 55-60)
- Terminación: pavonado y bocas pulidas
- Mangos recubiertos de material rugoso



Valores para 115125

Code	L mm	L "	Capac. max ∅ mm	Profundidad bocas mm	P.V.P. unid. €	
<b>115115</b>	150	6	28	26	<b>21,50</b>	6
<b>115120</b>	180	7	37	32	<b>24,00</b>	6
<b>115125</b>	240	9,5	49	38	<b>26,00</b>	6
<b>115130</b>	300	12	68	47	<b>37,00</b>	5
<b>115135</b>	400	16	95	64	<b>67,00</b>	3

Se suministra con colgador (excepto 115135)

## Tenaza pico de loro

DIN  
8976

ACERO  
CR-V



- Cremallera mecanizada
- Terminación cromado

Code	L mm	L "	Capac. max ∅ mm	P.V.P. unid. €	
<b>111199</b>	200	8	35	<b>17,00</b>	6
<b>111200</b>	250	10	50	<b>19,50</b>	6
<b>111201</b>	300	12	50	<b>28,90</b>	6

Se suministra con colgador

## Tenacilla de canal

DIN  
8976

ACERO  
CR-V



- Apertura en 7 posiciones
- Articulación machihembrada
- Bocas templadas
- Terminación pavonado

Code	L mm	L "	Capac. max ∅ mm	P.V.P. unid. €	
<b>115105</b>	250	10	36	<b>25,90</b>	6

Se suministra con colgador

**Alicate universal de alta potencia aislado**

DIN  
5746  
EN  
60900

**Alta potencia**

Marcado indeleble en cumplimiento de la norma EN 60900

ACERO  
CR-V

Mangos recubiertos de material especial aislante



**Certificado VDE**



**CAPACIDAD DE CORTE**

	Ø mm
	101804/ 101805
○	4/5
◐	2,8/3,5
◑	1,8/2,4
●	1,6/2



**NORMA EN 60900**

Trabajos en tensión de hasta 1000 V en Corriente Alterna ó 1500 V en Corriente Continua

Code	L mm	L "	P.V.P. unid. €	
<b>101804</b>	180	7	<b>23,84</b>	6
<b>101805</b>	200	8	<b>26,21</b>	5

Se suministra con colgador

**Alicate de corte diagonal aislado**

DIN  
5749  
EN  
60900

**Alta potencia**

ACERO  
CR-V



**CAPACIDAD DE CORTE**

Alambre	Ø mm
	101823 101824
○	4
◐	3
◑	2
●	1,6



Code	L mm	L "	P.V.P. unid. €	
<b>101823</b>	160	6	<b>22,26</b>	6
<b>101824</b>	180	7	<b>23,95</b>	5

Se suministra con colgador

**Alicate de puntas semirredondas aislado**

DIN  
5745  
EN  
60900

**Alta potencia**

ACERO  
CR-V



Code	L mm	L "	P.V.P. unid. €	
<b>101812</b>	160	6	<b>24,22</b>	6
<b>101813</b>	200	8	<b>26,66</b>	5

Se suministra con colgador

**Juego de alicates aislados**

**Alta potencia**



Medida caja: 255x185x48 mm



**COMPOSICION** 101804 / 101824 / 101813

Code	Nº Piezas	P.V.P. unid. €	
<b>101862</b>	3	<b>74,91</b>	1

## Alicate universal aislado

DIN  
5746  
EN  
60900

ACERO  
CR-V



### CAPACIDAD CORTE DE ALAMBRE

	Ø mm
	101801/ 101802/ 101803
○	4/4/4
◐	2,8/3/3
◑	1,8/2/2
●	1,4/1,6/1,6



Code	L mm	L "	P.V.P. unid. €	
<b>101801</b>	160	6	<b>19,73</b>	6
<b>101802</b>	180	7	<b>21,16</b>	6
<b>101803</b>	200	8	<b>23,26</b>	5

Se suministra con colgador

## Alicate de corte diagonal aislado

DIN  
5749  
EN  
60900

ACERO  
CR-V



Code	L mm	L "	P.V.P. unid. €	
<b>101821</b>	160	6	<b>19,73</b>	6
<b>101822</b>	180	7	<b>21,24</b>	5

Se suministra con colgador

## Alicate de corte diagonal reforzado aislado

DIN  
5749  
EN  
60900

ACERO  
CR-V



Code	L mm	L "	P.V.P. unid. €	
<b>101825</b>	180	7	<b>22,78</b>	6
<b>101826</b>	200	8	<b>25,52</b>	6

Se suministra con colgador

## Alicate puntas semirredondas aislado

DIN  
5745  
EN  
60900

ACERO  
CR-V



Code	L mm	L "	P.V.P. unid. €	
<b>101810</b>	160	6	<b>21,48</b>	6
<b>101811</b>	200	8	<b>23,64</b>	6

Se suministra con colgador

## Alicate puntas semirredondas curvo aislado

DIN  
5745  
EN  
60900

ACERO  
CR-V



Code	L mm	L "	P.V.P. unid. €	
<b>101815</b>	200	8	<b>25,49</b>	6

Se suministra con colgador

**Alicate de bocas planas aislado**

DIN  
5745  
EN  
60900

ACERO  
CR-V



Code	L mm	L "	P.V.P. unid. €	
<b>101835</b>	160	6	<b>20,32</b>	6

Se suministra con colgador

**Alicate pelacables aislado**

EN  
60900

ACERO  
CR-V



Code	L mm	L "	P.V.P. unid. €	
<b>101840</b>	160	6	<b>29,50</b>	6

Se suministra con colgador

**Alicate cortacables aislado**

EN  
60900

ACERO  
CR-V



**CAPACIDAD DE CORTE**

Code	Cable Ø mm
101848	<b>13,5</b>

- Forma especial de los fillos de corte para cables
- Terminación cabeza pulida
- Con tope mecánico
- Mangos bimateriales y ergonómicos



No válido para cortar alambre de Acero o conductores de Cobre trenzado

**Juego de alicates aislados**



**COMPOSICION** 101802 / 101822 / 101811

Code	Nº Piezas	P.V.P. unid. €	
<b>101860</b>	3	<b>67,00</b>	1

Medida caja: 255x185x48 mm

**Alicate de puntas redondas aislado**

DIN  
5745  
EN  
60900

ACERO  
CR-V



Code	L mm	L "	P.V.P. unid. €	
<b>101830</b>	160	6	<b>19,49</b>	6

Se suministra con colgador

**Tenacilla de canal aislada**

EN  
60900

ACERO  
CR-V



Code	L mm	L "	P.V.P. unid. €	
<b>101845</b>	240	9,5	<b>30,18</b>	6

Se suministra con colgador

## Alicate para arandelas Seeger

DIN 5254

ACERO CR-V

EXTERIORES BOCA RECTA



Code	Ø mm	L mm	P.V.P. unid. €	
<b>106202</b>	10 a 25	140	<b>15,48</b>	6
<b>106203</b>	19 a 60	180	<b>17,18</b>	6
<b>106204</b>	40 a 100	220	<b>19,58</b>	6
<b>106220</b>	85 a 165	300	<b>29,00</b>	6

Se suministra con colgador

DIN 5254

ACERO CR-V

EXTERIORES BOCA CURVA



Code	Ø mm	L mm	P.V.P. unid. €	
<b>106206</b>	10 a 25	140	<b>15,68</b>	6
<b>106207</b>	19 a 60	180	<b>17,70</b>	6
<b>106208</b>	40 a 100	220	<b>19,72</b>	6
<b>106225</b>	85 a 165	300	<b>29,50</b>	6

Se suministra con colgador

DIN 5256

ACERO CR-V

INTERIORES BOCA RECTA



Code	Ø mm	L mm	P.V.P. unid. €	
<b>106209</b>	12 a 25	140	<b>15,15</b>	6
<b>106210</b>	19 a 60	180	<b>17,26</b>	6
<b>106211</b>	40 a 100	220	<b>19,30</b>	6
<b>106230</b>	85 a 165	300	<b>29,00</b>	6

Se suministra con colgador

DIN 5256

ACERO CR-V

INTERIORES BOCA CURVA



Code	Ø mm	L mm	P.V.P. unid. €	
<b>106212</b>	12 a 25	140	<b>15,15</b>	6
<b>106213</b>	19 a 60	180	<b>17,84</b>	6
<b>106214</b>	40 a 100	220	<b>20,01</b>	6
<b>106235</b>	85 a 165	300	<b>29,50</b>	6

Se suministra con colgador

## Juego Alicates para arandelas, caja de plástico



Medida caja: 255x185x48 mm

### COMPOSICION

**101218** 106202 / 106206 / 106209 / 106212 (L 140 mm)

**101220** 106203 / 106207 / 106210 / 106213 (L 180 mm)

Code	Nº Piezas	P.V.P. unid. €	
<b>101218</b>	4	<b>61,46</b>	1
<b>101220</b>	4	<b>70,00</b>	1

## Juego Alicates para arandelas, bolsa nylon

L 220 MM



### COMPOSICION 106204 / 106208 / 106211 / 106214

Code	Nº Piezas	P.V.P. unid. €	
<b>101222</b>	4	<b>78,60</b>	1



**Tenaza Grip con bocas curvas con corte**

ACERO CR-V

Bocas forjadas y endurecidas por inducción

Tuerca moleteada de fijación para la regulación a la apertura deseada

Palanca de desbloqueo rápido

Terminación: bocas pulidas y niquelado

Bocas curvas con corta-alambres

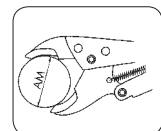

AM: apertura máxima

Code	L mm	L "	AM mm	P.V.P. unid. €	
<b>109101</b>	135	5,5	30	<b>9,60</b>	3
<b>109102</b>	190	7,5	42	<b>13,69</b>	3
<b>109103</b>	235	9	63	<b>15,70</b>	3

Se suministra en blister

**Tenaza Grip con bocas rectas**

ACERO CR-V

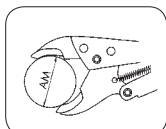

AM: apertura máxima

Code	L mm	L "	AM mm	P.V.P. unid. €	
<b>109104</b>	190	7,5	42	<b>13,82</b>	3
<b>109105</b>	235	9	63	<b>15,84</b>	3

Se suministra en blister

**Tenaza Grip de cadena**

ACERO CR-V



Capacidad máxima: Ø 160 mm

Code	L mm	L "	P.V.P. unid. €	
<b>109009</b>	250	10	<b>30,00</b>	1

Se suministra en blister

**Tenaza Grip tipo C**

ACERO CR-V



Code	L mm	L "	P.V.P. unid. €	
<b>109007</b>	300	12	<b>19,81</b>	1

Se suministra en blister

**Tenaza Grip para soldador**

ACERO CR-V



Code	L mm	L "	P.V.P. unid. €	
<b>109015</b>	300	12	<b>18,00</b>	1

Se suministra en blister

## Minialiccate de precisión de corte diagonal

ACERO  
CR-V



Tipo de corte biselado para una mayor capacidad de corte y vida del filo cortante

## Minialiccate de precisión universal



Code	L mm	L "	P.V.P. unid. €	
<b>113185</b>	115	4,5	<b>13,10</b>	12

Se suministra con colgador

## Minialiccate de precisión de bocas planas



Code	L mm	L "	P.V.P. unid. €	
<b>113165</b>	130	5	<b>13,10</b>	12

Se suministra con colgador

## Minialiccate de precisión de puntas semirredondas con corte



Code	L mm	L "	P.V.P. unid. €	
<b>113155</b>	140	5,5	<b>13,10</b>	12

Se suministra con colgador



## MANGOS DISIPATIVOS DE ELECTRICIDAD ESTÁTICA

Mangos recubiertos de material especial que disipan la electricidad estática generada al trabajar en aparatos eléctricos como electrodomésticos, ordenadores, circuitos electrónicos...

- Filos de corte endurecidos a 55-60 HRC
- Temple total del alicate
- Terminación pulido y lacado (antióxido)
- Mangos bimateriales antideslizantes
- Muelle para una utilización más ergonómica

Code	L mm	L "	P.V.P. unid. €	
<b>113175</b>	115	4,5	<b>13,10</b>	12

Se suministra con colgador

## Minialiccate de precisión de corte frontal



Code	L mm	L "	P.V.P. unid. €	
<b>113180</b>	115	4,5	<b>13,10</b>	12

Se suministra con colgador

## Minialiccate de precisión de bocas redondas



Code	L mm	L "	P.V.P. unid. €	
<b>113170</b>	130	5	<b>13,10</b>	12

Se suministra con colgador



**Minialicate de precisión de puntas semirredondas**



• Boca interior lisa



Code	L mm	L "	P.V.P. unid. €	
<b>113160</b>	150	6	<b>13,10</b>	12

Se suministra con colgador

**Minialicate para electrónica de corte diagonal**



• Ángulo de corte muy preciso debido a la técnica de fabricación



**21°**  
Ángulo corte

Code	L mm	L "	P.V.P. unid. €	
<b>113192</b>	125	5	<b>13,10</b>	12

Se suministra con colgador



**45°**  
Ángulo corte

Code	L mm	L "	P.V.P. unid. €	
<b>113194</b>	125	5	<b>13,10</b>	12

Se suministra con colgador

**Juego de minialicates**



Medida caja: 255x185x48 mm

**COMPOSICION** 113160 / 113175 / 113185 / 113180

Code	Nº Piezas	P.V.P. unid. €	
<b>113190</b>	4	<b>52,40</b>	1

**Pinza de precisión**

**ACERO INOX**



• Acabado antideslizante  
• Antimagnético, antiácido

Code	L mm	L "	P.V.P. unid. €	
<b>113142</b>	120	5	<b>5,50</b>	6

**Juego de alicates ESD y destornilladores de precisión**



Medida bolsa cerrada: 220x150x40 mm

**COMPOSICION**  
 113160 - 113175 - 113180  
 1,5x50 - 2x50 - 2,5x50  
 PH00x50 - PH0x50 - PH1x50

Code	Nº Piezas	P.V.P. unid. €	
<b>113195</b>	9	<b>56,09</b>	1

**ACERO INOX**



Code	L mm	L "	P.V.P. unid. €	
<b>113144</b>	120	5	<b>4,50</b>	6

## Tenaza de alta potencia

ACERO  
CR-V

### CAPACIDAD DE CORTE

Acero	Ø mm
114010	
○	6
◐	4,5
●	2,5



- Filos de corte endurecidos a HRC 58÷62
- Cuerpo templado a HRC 45
- Terminación pavonado

### PRINCIPIO DE ALTA POTENCIA

Distancia menor entre el eje de giro y el filo de corte.

Reducción del esfuerzo hasta un 50%



### DISTANCIA EJE-FILO TENAZA

L	Alta potencia	Standard
mm	20,5	30

Code	L mm	L "	P.V.P. unid. €	
<b>114010</b>	300	12	<b>24,00</b>	6

Se suministra con colgador

## Tenaza Rusa

DIN  
9242

ACERO  
CR-V



### CAPACIDAD DE CORTE

Acero	Ø mm
○	4
◐	3
●	2

- Filos de corte endurecidos por inducción
- Cabeza Pulida
- Terminación pavonado

Code	L mm	L "	P.V.P. unid. €	
<b>114005</b>	225	9	<b>10,76</b>	6
<b>114006</b>	250	10	<b>11,59</b>	6
<b>114007</b>	280	11	<b>12,55</b>	6
<b>114008</b>	300	12	<b>14,17</b>	6

Se suministra con colgador

## Tenaza Rusa, mangos plastificados

DIN  
9242

ACERO  
CR-V



Code	L mm	L "	P.V.P. unid. €	
<b>114015</b>	225	9	<b>11,49</b>	6
<b>114016</b>	250	10	<b>12,27</b>	6
<b>114017</b>	280	11	<b>13,18</b>	6
<b>114018</b>	300	12	<b>14,74</b>	6

Se suministra con colgador

## Tenaza de arrancar

DIN  
9243

ACERO  
CR-V



- Filos de corte endurecidos por inducción
- Cabeza Pulida
- Terminación pavonado

Code	L mm	L "	P.V.P. unid. €	
<b>114001</b>	160	6	<b>12,68</b>	6
<b>114002</b>	180	7	<b>15,12</b>	6
<b>114003</b>	200	8	<b>16,26</b>	6

Se suministra con colgador

**Alicate de corte diagonal articulado**

ACERO  
CR-V-MO

**CAPACIDAD DE CORTE**

Alambre	Ø mm
○	6
◐	5
◑	4
●	3,6



- Filos de corte templados 63 HRC
- Articulación que permite una gran capacidad de corte con el mínimo esfuerzo
- Tope mecánico
- Mangos bimateriales y ergonómicos
- Terminación pavonado

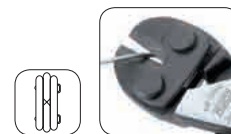

Code	L mm	L "	P.V.P. unid. €	
<b>110320</b>	200	8	<b>32,91</b>	5

Se suministra con colgador

**Alicate de corte diagonal articulado 35°**

ACERO  
CR-V-MO

**CAPACIDAD DE CORTE**

Alambre	Ø mm
○	6
◐	5
◑	4
●	3,6



Especial para corte al RAS debido a la inclinación de 35° de la cabeza

- Mismas características y capacidad de corte que 110320

Code	L mm	L "	P.V.P. unid. €	
<b>110322</b>	200	8	<b>37,25</b>	5

Se suministra con colgador

**Cortaalambrs para una mano**

ACERO  
CR-V

**CAPACIDAD DE CORTE**

Alambre	Ø mm
◐	3
◑	2
●	1,6



**PARA CORTE DE ACERO**

- Corte por cizalla
- Con muelle y tope de seguridad
- Mangos plastificados en PVC

Code	L mm	L "	P.V.P. unid. €	
<b>123200</b>	180	7	<b>25,11</b>	1

Se suministra en blister

**Cortaalambrs para dos manos**

ACERO  
CR-V

**CAPACIDAD DE CORTE**

Alambre	Ø mm
◐	14
◑	12
●	10



**PARA CORTE DE ACERO**

- Bocas forjadas intercambiables
- Corte por cizalla
- Mangos de aluminio inyectado. Muy ligeros
- Elastómero antideslizante en los mangos

Code	L mm	L "	P.V.P. unid. €	
<b>123210</b>	600	24	<b>205,92</b>	1

**CUCHILLA DE RECAMBIO**

<b>123215</b>	para code 123210		<b>124,25</b>	1
---------------	------------------	--	---------------	---

## Cortabulón-doblador de barras

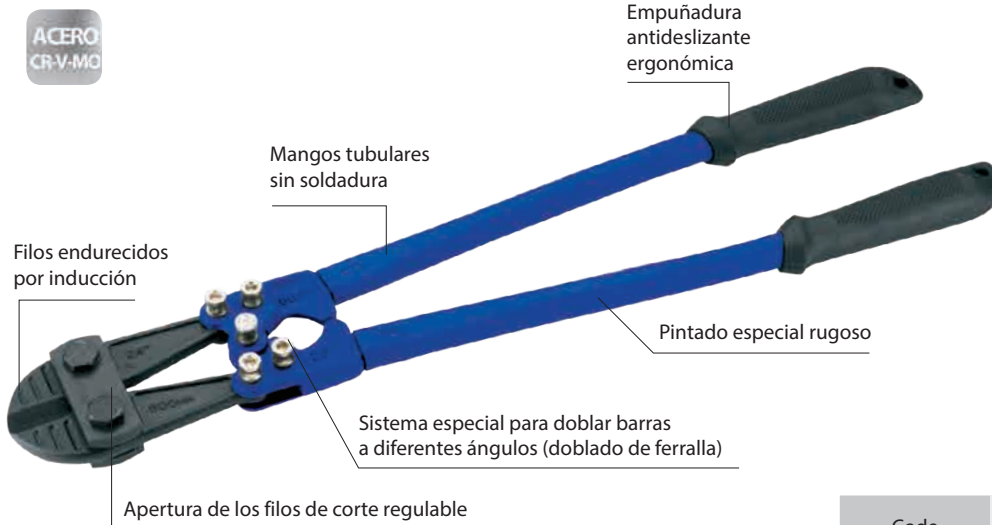

### MODO EMPLEO DOBLADOR BARRAS

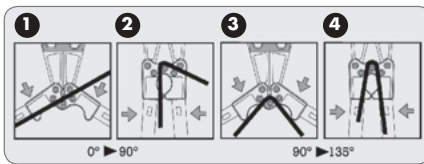

### REGULACION DE FILOS DE CORTE

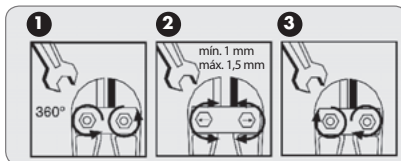

## Cortabulón de filos intercambiables

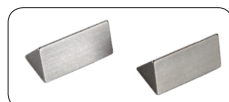
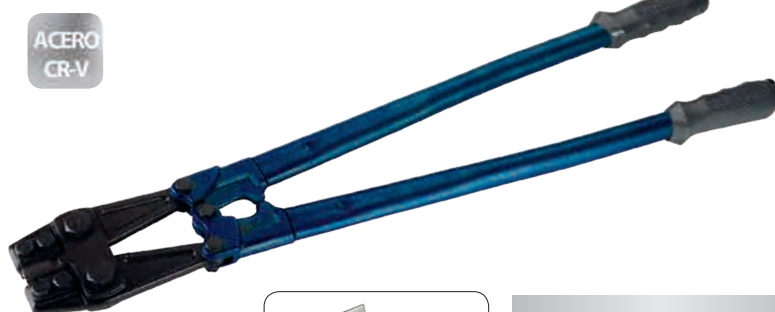

Cuchilla de recambio con 3 filos de corte útiles

### CAPACIDAD DE CORTE

Code	Acero 15 HRC	Acero 40 HRC
123036	13	10
123038	13	10

### CAPACIDAD DE CORTE-DOBLADO

Code	Corte acero Ø mm		Doblado Ø mm
	15 HRC	40 HRC	
123010	7	4	-
123031	8	5	6
123032	10	6	8
123033	13	7	9
123034	16	8	12



Code	L mm	L "	P.V.P. unid. €	
<b>123010</b>	350	14	<b>40,17</b>	1
<b>123031</b>	450	18	<b>55,00</b>	1
<b>123032</b>	600	24	<b>64,52</b>	1
<b>123033</b>	750	30	<b>86,08</b>	1
<b>123034</b>	900	36	<b>106,81</b>	1

### CUCHILLA DE RECAMBIO

<b>123110</b>	para code 123010	<b>26,39</b>	1
<b>123111</b>	para code 123031	<b>32,67</b>	1
<b>123112</b>	para code 123032	<b>40,16</b>	1
<b>123113</b>	para code 123033	<b>51,20</b>	1
<b>123114</b>	para code 123034	<b>58,99</b>	1

### EXPOSITOR

Code	Nº Piezas	P.V.P. unid. €
<b>123120</b>	7	<b>513,24</b>

**COMPOSICION** 123031 (2) / 123032 (2)  
123033 (2) / 123034 (1)

- Bocas forjadas en Acero
- Filos de corte intercambiables en Acero al Cr-V dureza 56-61 HRC
- Mangos tubulares sin soldadura
- Elastómero antideslizante en los mangos

Code	L mm	L "	P.V.P. unid. €	
<b>123036</b>	600	24	<b>68,25</b>	1
<b>123038</b>	900	36	<b>112,91</b>	1
<b>123037</b>	para 123036/123038		<b>27,85</b>	1

### CUCHILLA DE RECAMBIO

**Alicate cortacable**

ACERO  
CR-V

**Alta potencia**

CAPACIDAD DE CORTE	
Code	Cable Ø mm
108052	13,5



**40% MENOR ESFUERZO**



No válido para cortar alambre de Acero o conductores de Cobre trenzado

- Filo de corte templado por inducción
- Forma especial de los fillos de corte. Modelo Japonés.
- Con tope mecánico
- Mangos ergonómicos bimeriales

Code	L mm	L "	P.V.P. unid. €	
<b>108052</b>	240	10	<b>45,00</b>	1

Se suministra con colgador

**Cortacables automático**

ACERO  
CR-V

CAPACIDAD DE CORTE	
Code	Cable Ø mm
108046	9,5
108048	13,5



No válido para cortar alambre de Acero o conductores de Cobre trenzado

- Cuerpo templado 40-48 HRC. Fillos de corte templados por inducción a 58-63 HRC
- Forma especial de los fillos. Corte limpio sin deformaciones ni aplastamiento del cable

Code	L mm	L "	P.V.P. unid. €	
<b>108046</b>	170	7	<b>44,99</b>	2
<b>108048</b>	230	9	<b>53,21</b>	2

Se suministra con colgador

**Cortacables para cobre y aluminio de dos manos**

ACERO  
CR-V

CAPACIDAD DE CORTE	
Cable	Ø mm
Cobre	18
Alum	26



No válido para cortar alambre de Acero o conductores de Cobre trenzado

- Cortacables para cables de aluminio/cobre sin armar
- Con tope mecánico
- Mangos tubulares de aluminio con fundas ergonómicas

Code	L mm	L "	P.V.P. unid. €	
<b>108055</b>	600	24	<b>142,00</b>	1

**Cortacables de carraca**

ACERO  
CR-V

CAPACIDAD DE CORTE	
Cable de alta tensión	Ø mm
3KV CV 150x3C	46
6KV CV 100x3C	52

CAPACIDAD DE CORTE	
Cable normal	Ø mm
400 mm <sup>2</sup>	52

**MCM 750**



**PARA CORTE DE CABLE DE COBRE Y ALUMINIO**

**Nuevo**



No válido para cortar alambre de Acero o conductores de Cobre trenzado

- Filo de corte templado por inducción
- Corte limpio sin deformación y aplastamiento
- Cómodo manejo con una sola mano por el efecto carraca
- Con tope mecánico
- Mangos ergonómicos bimeriales

Code	L mm	L "	P.V.P. unid. €	
<b>108057</b>	280	11	<b>248,00</b>	1

## Pelacables automático de precisión



### PELADO EN UN MOVIMIENTO

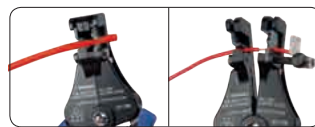

Colocar el cable entre las cuchillas

Con tope longitud para rabajos repetitivos

Pelacables	Min	Max
Ø mm	0,5	3,2
Sección mm <sup>2</sup>	0,2	8
AWG	24	8

Code	L mm	L "	P.V.P. unid. €	
<b>108392</b>	170	7	<b>31,40</b>	1

Se suministra en blister

## Pelacables automático



Pelacables	Min	Max
Ø mm	0,5	2,6
Sección mm <sup>2</sup>	0,2	6
AWG	24	10



Pelado longitudinal ajustable de 8 a 20 mm



Precisión de pelado para cables de 0,2 a 6 mm<sup>2</sup>



Cortables Ø máx. 2 mm

Code	L mm	L "	P.V.P. unid. €	
<b>108390</b>	180	7	<b>25,89</b>	1

Se suministra en blister

## Alicate pelacables multifunción



- ENGASTADOR
- Aisladas 0,5 - 6 mm<sup>2</sup>
- No aisladas 5 - 6 mm<sup>2</sup>
- Autoignición 7 - 8 mm



Tornillo de precisión para pelar cables muy finos

Pelacables	Min	Max
Ø mm	0,2	3,6
Sección mm <sup>2</sup>	0,05	10
AWG	30	14

Code	L mm	L "	P.V.P. unid. €	
<b>108370</b>	210	8	<b>26,00</b>	1

Se suministra en blister

## Pelamangueras



INCLUYE:



- Uña extractora exterior
- Tornillo para ajuste de la profundidad de corte

Code	L mm	Ø Pelado	P.V.P. unid. €	
<b>108080</b>	190	8-28	<b>19,00</b>	1

### CUCHILLA DE RECAMBIO

<b>108081</b>	para code 108080		<b>5,12</b>	1
---------------	------------------	--	-------------	---

Se suministra en blister



- Palanca de giro de 90° de la cuchilla. Corte longitudinal
- Regulación de profundidad de corte por giro de la cabeza

Code	L mm	Ø Pelado	P.V.P. unid. €	
<b>108085</b>	140	8-28	<b>22,72</b>	1

### CUCHILLA DE RECAMBIO

<b>108086</b>	para code 108085		<b>6,30</b>	1
---------------	------------------	--	-------------	---

Se suministra en blister



**Engastador de carraca para conectores de red**

CON FUNCION DE CARRACA



PARA CONECTORES  
**RJ11 6P4C**  
**RJ12 6P6C**  
**RJ45 8P8C**

**4 FUNCIONES DIFERENTES**



Pelacables planos



Pelacables redondos



Corte de cables de red



Engastado de los conectores

- Cuerpo metálico tratado térmicamente
- Con mecanismo de carraca para más fácil utilización
- Mangos bicomponentes

Code	L mm	P.V.P. unid. €	
<b>108375</b>	200	<b>69,00</b>	1

Se suministra en blister

**Engastador para conectores de red**

Mango ergonómico recubierto de PVC

Engastador



Base de goma antideslizante y ergonómica

PARA CONECTORES  
**RJ11 6P4C**  
**RJ12 6P6C**  
**RJ45 8P8C**

**FUNCIONES**

- Pelacables
- Engastador
- Cortacables

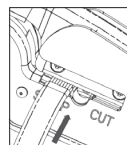

Cable plano

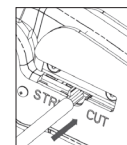

Cable redondo

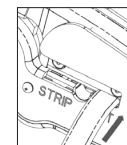

Cortacables

Code	L mm	P.V.P. unid. €	
<b>108377</b>	140	<b>48,00</b>	1

Se suministra en blister

**Pelacables fibra óptica**

Mangos bicomponentes

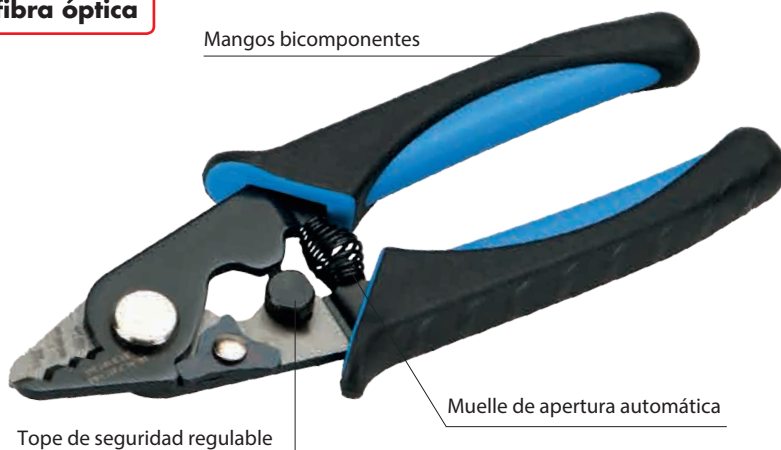

Tope de seguridad regulable

Muelle de apertura automática

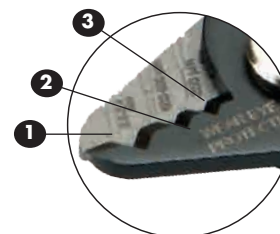

Muesca doble en "V". Cada muesca se utiliza para cada recubrimiento del cable

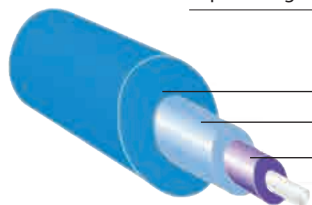

- 1 Recubrimiento exterior 2-3 mm
- 2 Aislante interior 600-900 µm
- 3 Funda acrílica 125-250 µm
- 4 Núcleo fibra óptica

Code	L mm	P.V.P. unid. €	
<b>108075</b>	150	<b>22,54</b>	1

Se suministra en blister

## Prensa-terminales aislados de carraca



### PARA TERMINALES AISLADAS 0,5 - 6 mm<sup>2</sup>



Incluida cabeza 108356

- Cabezas intercambiables tratadas térmicamente
- Mecanismo para ajuste de la fuerza de prensado
- Mecanismo de carraca para una utilización más cómoda
- Palanca de soltado. No permite abrir la herramienta hasta finalizar el engastado si no se acciona esta palanca

Code	L mm	P.V.P. unid. €	
<b>108355</b>	250	<b>75,00</b>	1

Se suministra en blister

## Prensa-terminales no aislados de carraca



### PARA TERMINALES NO AISLADAS 0,5 - 6 mm<sup>2</sup>



Incluida cabeza 108361

- Mismas características que 108355

Code	L mm	P.V.P. unid. €	
<b>108360</b>	250	<b>63,00</b>	1

Se suministra en blister

## Cabezas intercambiables para prensa-terminales

- Fácil acoplamiento al alicate mediante dos tornillos
- Válidas para code 108355 y 108360

Code	P.V.P. unid. €	
<b>108356</b>	<b>24,88</b>	1
<b>108361</b>	<b>24,88</b>	1
<b>108364</b>	<b>24,88</b>	1
<b>108366</b>	<b>24,88</b>	1
<b>108367</b>	<b>24,88</b>	1
<b>108368</b>	<b>24,88</b>	1
<b>108369</b>	<b>24,88</b>	1

Terminales aisladas  
0,5-6 mm<sup>2</sup>



108356

Terminales no aisladas  
0,5-6 mm<sup>2</sup>



108361

Terminales tubulares  
0,5-6 mm<sup>2</sup>



108368

Terminales tubulares  
6-16 mm<sup>2</sup>



108369

Terminales de barril  
0,5-6 mm<sup>2</sup>



108364

Terminales coaxial BNC/TNC  
RG-58/RG-59/62



108366

Terminales coaxial CATV  
RG-59/RG-6



108367

## Juego prensa-terminales



Medida caja: 290 x 230 x 55 mm



### COMPOSICION

- 1 Alicata prensa-terminales
- 7 cabezas intercambiables 108356 (montada), 108361, 108364, 108366, 108367, 108368, 108369
- 1 Llave allen
- 2 Tornillos de recambio

Code	Nº piezas	P.V.P. unid. €	
<b>108352</b>	11	<b>143,92</b>	1

## Pelacables coaxial



Portacuchillas con cuchillas preajustadas

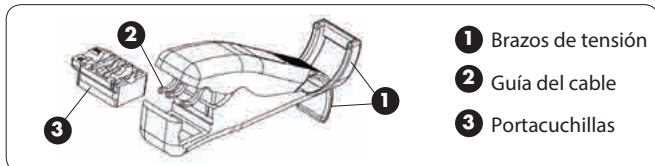

- 1 Brazos de tensión
- 2 Guía del cable
- 3 Portacuchillas



Diseño especial para pelar cables de antena en una sola operación (RG6 - RG59)

### INSTRUCCIONES DE USO

1. Presionar ambos brazos de tensión e introducir el cable
2. Mantener el cable presionado con una mano a las cuchillas y con la otra girar la herramienta alrededor del cable 3 veces (el número de vueltas puede variar dependiendo del tipo de cable)

- Longitud de pelado del cable preajustado en el portacuchillas de plástico
- Cuerpo fabricado en nylon de alta calidad

Code	L mm	P.V.P. unid. €	
108380	150	17,49	1

Se suministra en blister

## Alicate para terminales aisladas-no aisladas

PARA TERMINALES AISLADAS

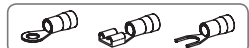

PARA TERMINALES NO AISLADAS

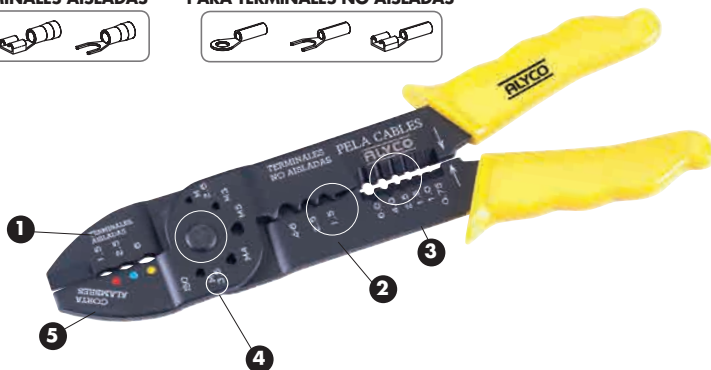

- 1 Engastado de terminales aislados (0,5-6 mm<sup>2</sup>)
- 2 Engastado de terminales no aislados (0,5-6 mm<sup>2</sup>)
- 3 Pelacables (0,5-6 mm<sup>2</sup>)
- 4 Cortatornillos sin rebaba de M2,5 a M5
- 5 Corte de alambre

Code	L mm	P.V.P. unid. €	
108002	250	12,00	4

Se suministra en blister

## Alicate para terminales no aisladas

PARA TERMINALES NO AISLADAS  
0,5 - 6 mm<sup>2</sup>

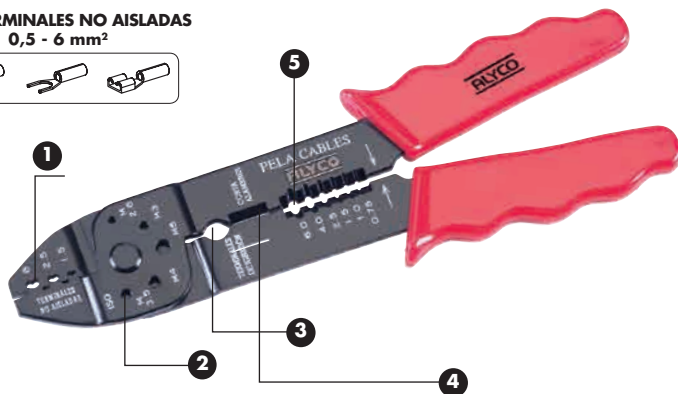

- 1 Prensa terminales no aisladas (0,75-6mm<sup>2</sup>)
- 2 Cortador de tornillos entre M2'5 y M5
- 3 Para utilizar con terminales de ignición
- 4 Cortaalambre
- 5 Pelacables (0,75-6mm<sup>2</sup>)

Code	L mm	P.V.P. unid. €	
108003	250	8,50	4

Se suministra en blister

## Juego alicate para terminales



Medida caja: 375 x 275 x 55 mm



### COMPOSICION



alicate tijera tester terminales

### TERMINALES AISLADAS



Code	Nº piezas	P.V.P. unid. €	
108006	147	50,82	1

## Tijera electricista reforzada

**Nuevo**

ACERO  
INOX

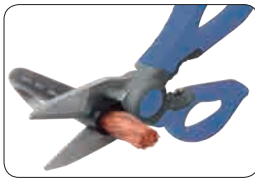

Muesca pelacables

### CAPACIDAD DE CORTE

Cable Ø mm	Sección mm <sup>2</sup>
15	70

Engastador

Mango en TPR  
(goma termoplástica)

Estructura metálica  
en todo el mango



Pelacables 1,5-2,5 mm<sup>2</sup>

Filos de corte templados  
y microdentados

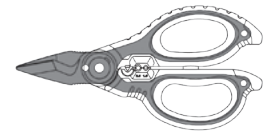

Tijera no aislada. No utilizar en circuitos eléctricos sometidos a tensión

**Gran ergonomía de los mangos que permite una gran capacidad de corte con un mínimo esfuerzo. Ideal para trabajos repetitivos**

FILO DE 40 MM

Code	L mm	L "	P.V.P. unid. €	
<b>108220</b>	160	6 1/2	<b>16,90</b>	12

Se suministra en blister

## Tijera electricista reforzada con funda

**Nuevo**



Orificio para fijación de la tijera

### COMPOSICION

- 1 Tijera 108220
- 1 funda con clip y ranura de cinturón

Code	P.V.P. unid. €	
<b>108225</b>	<b>17,90</b>	12

Se suministra en blister

## Kit para electricista reforzado

**Nuevo**



### COMPOSICION

- 1 Tijera 108220
- 1 Cuchillo 108230
- 1 Bolsa de nylon

• Bolsa de nylon reforzada en las uniones  
• Tira en la parte superior ranurada para acoplar a cinturón

Code	P.V.P. unid. €	
<b>108235</b>	<b>29,10</b>	6

Se suministra en blister

**Tijera multiusos para electricista**

ACERO INOX

FILO DE 50 MM



Tijera no aislada. No utilizar en circuitos eléctricos sometidos a tensión

- Filos de corte dentados
- Mangos ergonómicos en Nylon de gran resistencia y elastómero blando
- Muesca pelacables

Code	L mm	L "	P.V.P. unid. €	
<b>108015</b>	145	5,5	<b>10,11</b>	12
EXPOSITOR				
<b>108040</b>	24 tijeras		<b>242,58</b>	1

**Tijera para electricista con funda**



Orificio para fijación de la tijera

Code	Tipo	P.V.P. unid. €	
<b>108215</b>	Tijera+ funda	<b>12,81</b>	12
<b>108210</b>	Funda	<b>3,39</b>	12

Se suministra en blister

**Kit para electricista**



**COMPOSICION**

- 1 Tijera 108015
- 1 Navaja 108030
- 1 Bolsa de cuero

- Bolsa de cuero reforzada con remaches en las uniones
- Tira en la parte superior ranurada para acoplar a cinturón

Code	P.V.P. unid. €	
<b>108020</b>	<b>19,59</b>	6

Se suministra en blister

**Tijera para electricista aislada**

EN 60900

FILO DE 45 MM

ACERO INOX



**NORMA EN 60900**

Herramientas aisladas utilizadas para trabajos en tensiones de hasta 1000V en Corriente Alterna ó 1500 V en Corriente Continua

Certificado VDE



- Mangos bicomponentes en material aislado
- Filos de corte templados HRC 51 ÷ 53
- Muecas para pelar cables

Code	L mm	P.V.P. unid. €	
<b>108315</b>	165	<b>22,00</b>	6

Se suministra en blister

## Tijera para electricista reforzada

ACERO INOX

FILO DE 60 MM



Tijera no aislada. No utilizar en circuitos eléctricos sometidos a tensión

- Filos de corte dentados con muesca pelacables
- Muelle de apertura automática y seguro

Code	L mm	P.V.P. unid. €	
<b>108035</b>	210	<b>16,16</b>	6

Se suministra en blister

## Tijera reforzada de corte oblicuo

ACERO INOX

FILO DE 100 MM



Tijera no aislada. No utilizar en circuitos eléctricos sometidos a tensión

- Filos de corte endurecidos y dentados
- Muelle de apertura automática y seguro

Code	L mm	P.V.P. unid. €	
<b>108125</b>	250	<b>17,13</b>	6

Se suministra en blister

## Tijera multiuso

ACERO INOX



Code	L mm	P.V.P. unid. €	
<b>108330</b>	150	<b>13,03</b>	6
<b>108335</b>	200	<b>15,98</b>	6
<b>108340</b>	250	<b>20,78</b>	6

Se suministra en blister

## Tijera doméstica

ACERO INOX

FILO DE 50 MM



- Filos microdentados • Gran muesca para sujeción
- Hendidura para partir objetos • Abre botellas

Code	L mm	P.V.P. unid. €	
<b>108350</b>	220	<b>20,96</b>	6

Se suministra en funda

## Cuchillo pelacables

ACERO INOX

### CAPACIDAD DE CORTE

Cable Ø mm	Sección mm <sup>2</sup>
<b>30</b>	<b>120</b>



FILO DE CORTE 50 MM



Instrucciones de uso

### MODO DE USO

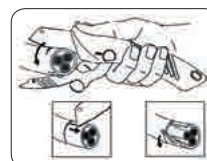

Protector plástico de la hoja para evitar cortes accidentales, apoyar el cable a la hora de cortar y utilizar como pelacables

Code	L mm	P.V.P. unid. €	
<b>108230</b>	200	<b>9,95</b>	12

Se suministra en blister

**Nuevo**

**Navaja para electricista**

ACERO  
INOX

FILO DE CORTE  
65 MM



Navaja no aislada. No utilizar en circuitos eléctricos sometidos a tensión

- Hoja de 2,5 mm de espesor
- Filo de corte liso y dentado
- Doble muesca para pelar cables
- Mango ergonómico bimaterral

Code	L abierta mm	L cerrada mm	P.V.P. unid. €	
<b>108032</b>	210	120	<b>12,47</b>	12
<b>EXPOSITOR</b>				
<b>108034</b>	24 unidades		<b>299,27</b>	1

Se suministra en blister

**Navaja en bolsa de nylon**

ACERO  
INOX

FILO DE CORTE  
85 MM



Clip metálico



Bolsa de nylon

- Cuerpo de Aluminio con refuerzo interior metálico
- Zona de contacto con la mano recubierta de madera. Forma ergonómica
- Clip metálico en la parte posterior
- Sistema de bloqueo de la hoja en posición abierta
- Se suministra en bolsa de nylon individual

Code	L mm abierto	L mm cerrado	P.V.P. unid. €	
<b>101270</b>	205	120	<b>13,90</b>	6

Se suministra en blister y expositor

**Navaja de mango de aluminio**

ACERO  
INOX

FILO DE CORTE  
85 MM



Clip metálico

- Hoja en Acero inoxidable templado
- Mango de aluminio anodizado y plástico duro antideslizante
- Sistema de bloqueo de la hoja en posición abierta

Code	L mm abierto	L mm cerrado	P.V.P. unid. €	
<b>101272</b>	190	115	<b>11,80</b>	6

Se suministra en blister

## Navaja para electricista de doble hoja

ACERO  
INOX

FILO DE CORTE  
60 MM



Navaja no aislada. No utilizar en circuitos eléctricos sometidos a tensión

Code	L abierta mm	L cerrada mm	P.V.P. unid. €	
<b>101276</b>	210	110	<b>10,70</b>	6

Se suministra en blister

## Navaja para electricista mango madera

ACERO  
INOX

FILO DE CORTE  
60 MM



Navaja no aislada. No utilizar en circuitos eléctricos sometidos a tensión

Code	L abierta mm	L cerrada mm	P.V.P. unid. €	
<b>101274</b>	210	110	<b>8,47</b>	6

Se suministra en blister

## Cuchillo para electricista

ACERO  
INOX

FILO DE CORTE  
45 MM



Cuchillo no aislado. No utilizar en circuitos eléctricos sometidos a tensión

- Hoja de 2,5 mm de espesor pulida
- Filo de corte endurecido a 57 - 60 HRC
- Mango fabricado en nylon de gran resistencia
- Con protector de plástico

Code	L mm	P.V.P. unid. €	
<b>108030</b>	155	<b>6,44</b>	12

## Cuchillo pelamangueras aislado para electricista

EN  
60900

FILO DE CORTE  
40 MM

ACERO  
CR-V



Certificado VDE



- Mango recubierto de material aislante con tope de seguridad
- Doble filo de corte, curvo y recto
- La uña no daña al conductor

Code	L mm	P.V.P. unid. €	
<b>108095</b>	200	<b>19,00</b>	6

Se suministra en blister

## Cuchillo aislado para electricista

EN  
60900

FILO DE CORTE  
50 MM

ACERO  
CR-V



- Mango recubierto de material aislante con tope de seguridad

Code	L mm	P.V.P. unid. €	
<b>108090</b>	200	<b>14,00</b>	6

Se suministra en blister



**Tijera cortachapas articulada corte recto**

ACERO  
CR-V



**CAPACIDAD DE CORTE**

Chapa	Grosor mm
Cobre	1,5
Acero laminado	1,2
Acero HRC30	1



- Bocas forjadas
- Muelle de brazos que automatiza la apertura
- Filos dentados endurecidos, antideslizantes
- Sistema articulado que multiplica el esfuerzo
- Cierre de seguridad
- Mangos ergonómicos bimateriales

Code	L mm	L "	P.V.P. unid. €	
<b>108100</b>	250	10	<b>16,31</b>	6

Se suministra en blister

**Tijera cortachapas corte recto boca larga**

ACERO  
CR-V



Code	L mm	L "	P.V.P. unid. €	
<b>108105</b>	300	12	<b>17,30</b>	6

Se suministra en blister

**Tijera cortachapas acodada corte a izquierda**

ACERO  
CR-V

REFORZADA



Code	L mm	L "	P.V.P. unid. €	
<b>108110</b>	250	10	<b>18,61</b>	6

Se suministra en blister

**Tijera cortachapas acodada corte a derecha**

ACERO  
CR-V

REFORZADA



Code	L mm	L "	P.V.P. unid. €	
<b>108120</b>	250	10	<b>18,61</b>	6

Se suministra en blister

**Tijera para chapa modelo Madrid**



- Bocas forjadas en Acero
- Con tope superior
- Presentación pintado, bocas pulidas

Code	L mm	L "	P.V.P. unid. €	
<b>108300</b>	250	10	<b>16,93</b>	6
<b>108302</b>	300	12	<b>23,47</b>	6

Se suministra en blister



## 04 Llaves



Llave fija de dos bocas 81



Llave combinada 83



Llave de estrella acodada 85



Llave de estrella plana 87



Llave aislada 88



Llave fija de una boca 90



Llave de golpe 91



Llave acodada con carraca 92



Llave combinada con carraca 93



Llave combinada con carraca 94



Llave de tubo 96



Llave de pipa 98



Llave para ruedas 99



Llave ajustable 100



Llave articulada 104



Llave dinamométrica 105

**Llave fija de 2 bocas**

**DIN**  
3110

**ACERO**  
CR-V

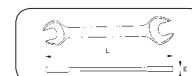

- Acodado de 30° para acceso a lugares difíciles
- Bocas con chaflán para un fácil encaje en la tuerca
- Cromado satinado mate y cabezas pulidas

Code	mm	L mm	E mm	P.V.P. unid. €	
191004	4x5	105	3,2	2,75	10
191005	6x7	122	3,2	2,85	10
191010	8x9	140	3,5	2,96	10
191015	10x11	156	4,5	3,10	10
191012	10x13	172	5,1	3,67	10
191020	12x13	172	5	3,81	10
191028	13x17	188	5,6	4,72	10
191025	14x15	188	5,5	4,05	10
191030	16x17	204	6	4,79	10
191033	17x19	220	6,5	5,19	10
191035	18x19	220	6,5	5,24	10
191038	19x22	234	7,2	6,14	5
191040	20x22	234	7,5	6,44	5
191045	21x23	247	7,5	6,65	5
191047	22x24	247	7,5	6,81	5
191050	24x26	266	8,5	7,81	5
191055	24x27	266	8,5	8,00	5
191060	25x28	285	8,5	8,89	5
191065	27x29	300	9,5	10,29	5
191070	30x32	302	9,5	12,07	5
191072	32x36	320	10	19,92	5
191073	34x36	320	10	20,91	5
191075	36x41	380	12,2	23,30	4
191076	41x46	415	14,7	34,53	2
191077	46x50	465	15,7	43,15	2



Code	"	L mm	E mm	P.V.P. unid. €	
190002	1/4"x5/16"	122	3,3	2,85	1
190004	5/16"x3/8"	140	3,6	2,96	1
190006	3/8"x7/16"	156	4,6	3,10	1
190008	7/16"x1/2"	172	5,1	3,81	1
190010	1/2"x9/16"	180	5,1	4,05	1
190012	9/16"x5/8"	188	5,6	4,27	1
190014	5/8"x11/16"	204	6,1	4,79	1
190016	11/16"x3/4"	220	6,5	5,24	1
190018	3/4"x7/8"	234	7,2	5,57	1
190020	13/16"x7/8"	247	7,5	6,66	1
190022	15/16"x1"	266	8,2	7,81	1
190024	1"x1-1/8"	285	8,4	8,89	1
190026	1-1/8"x1-5/16"	302	9,1	11,07	1
190028	1-1/16"x1-1/4"	302	9,1	12,07	1
190030	1-7/16"x1-5/8"	380	12,2	23,27	1

**Juego de Llaves fijas, soporte plástico**



**COMPOSICION**

6x7, 8x9, 10x11, 12x13, 14x15, 16x17, 18x19, 20x22 mm

Code	Nº Piezas	P.V.P. unid. €	
191091	8	33,01	2

## Juego de Llaves fijas, caja cartón



### COMPOSICION

**191082:** 8x9, 10x11, 12x13, 14x15, 16x17, 18x19 mm  
**191080:** 6x7, 8x9, 10x11, 12x13, 14x15, 16x17, 18x19, 20x22 mm

Code	Nº Piezas	P.V.P. unid. €	
<b>191082</b>	6	<b>23,95</b>	2
<b>191080</b>	8	<b>32,94</b>	2

## Juego de Llaves fijas, bolsa de nylon



### COMPOSICION

**191081:** 6x7, 8x9, 10x11, 12x13, 14x15, 16x17, 18x19, 20x22 mm  
**190040:** 1/4"x5/16" • 5/16"x3/8" • 3/8"x7/16" • 1/2"x9/16" • 9/16"x5/8" • 5/8"x11/16" • 11/16"x3/4" • 3/4"x7/8"

Code	Nº Piezas	P.V.P. unid. €	
<b>191081</b>	8	<b>33,01</b>	2
<b>190040</b>	8	<b>34,05</b>	2



### COMPOSICION

**191086:** 6x7, 8x9, 10x11, 12x13, 14x15, 16x17, 18x19, 20x22, 21x23, 24x27, 25x28, 30x32 mm  
**190045:** 1/4"x5/16" • 5/16"x3/8" • 3/8"x7/16" • 1/2"x9/16" • 9/16"x5/8" • 5/8"x11/16" • 11/16"x3/4" • 3/4"x7/8" • 13/16"x7/8" • 15/16"x1" • 1"x1-1/8" • 1-1/16"x1-1/4"

Code	Nº Piezas	P.V.P. unid. €	
<b>191086</b>	12	<b>69,01</b>	2
<b>190045</b>	12	<b>70,05</b>	2



## Juego de Llaves fijas, soporte plástico



Medida caja: 255x185x48 mm

### COMPOSICION

6x7, 8x9, 10x11, 12x13, 14x15, 16x17, 18x19, 20x22, 21x23, 24x27, 25x28, 30x32 mm

Code	Nº Piezas	P.V.P. unid. €	
<b>191085</b>	12	<b>69,01</b>	2

## Juego de Llaves fijas, caja plástico

### COMPOSICION

6x7, 8x9, 10x11, 12x13, 14x15, 16x17, 18x19, 20x22 mm

Code	Nº Piezas	P.V.P. unid. €	
<b>191096</b>	8	<b>32,90</b>	2

**Llave combinada**

DIN  
3113

ACERO  
CR-V



Aristas redondeadas

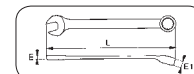

• Cromado satinado mate y cabezas pulidas

Code	mm	L mm	E mm	E1 mm	P.V.P. unid. €	
191203	6	110	3,6	5	3,75	10
191206	7	110	3,6	5,5	3,80	10
191209	8	120	4,1	6	3,85	10
191212	9	130	4,1	6,5	4,50	10
191215	10	140	4,6	7	4,55	10
191218	11	150	5	7	4,99	10
191221	12	160	5,1	7,5	5,26	10
191224	13	170	5,5	8	5,58	10
191227	14	180	5,8	8,5	5,76	5
191230	15	190	6	9	5,96	5
191233	16	200	6,2	9,5	6,38	5
191236	17	210	6,5	10	6,80	5
191239	18	220	6,7	10,5	7,19	5
191242	19	230	7,3	11	8,14	5
191245	20	240	7,5	11,5	8,28	5
191248	21	250	7,8	12	9,36	5
191251	22	260	8	12,5	9,50	5
191254	23	260	8	12,5	10,14	5
191257	24	280	8,5	13,5	10,58	5
191260	25	295	8,8	14	11,40	5
191263	26	295	8,8	14	13,89	5
191266	27	310	9	15	14,98	5
191269	28	340	9,5	16,5	15,94	5
191272	29	340	9,5	16,5	16,09	5
191275	30	340	9,5	16,5	16,33	5
191278	32	360	9,7	17,5	18,27	5
191279	34	380	11,5	18	20,58	2
191281	36	410	13	18,2	30,32	2
191282	41	460	15,5	20	37,66	2
191283	46	500	16,2	21	48,09	2
191284	50	540	17,2	22,6	55,85	2



Code	"	L mm	E mm	E1 mm	P.V.P. unid. €	
190100	1/4"	100	3,7	4,5	3,75	1
190102	5/16"	120	4,1	5,5	3,85	1
190104	11/32"	130	4,1	6	4,50	1
190106	3/8"	140	4,6	6,5	4,55	1
190108	7/16"	150	4,7	6,5	4,99	1
190110	1/2"	170	5,5	7,5	5,58	1
190112	9/16"	180	5,6	8	5,76	1
190114	5/8"	200	5,8	9	6,38	1
190116	11/16"	210	6,3	9,5	7,19	1
190118	3/4"	230	7,1	10,4	8,14	1
190120	13/16"	250	7,5	11,4	9,36	1
190122	7/8"	260	8	11,9	9,50	1
190124	15/16"	280	8,2	12,9	10,58	1
190126	1"	295	8,7	13,4	11,40	1
190128	1-1/16"	310	8,9	14,4	14,98	1
190130	1-1/8"	340	10	15,9	15,95	1
190132	1-1/4"	360	10,8	16,9	18,27	1

**Juego de Llaves combinadas, soporte plástico**

**COMPOSICION**

8, 10, 11, 12, 13, 14, 17, 19 mm

Code	Nº Piezas	P.V.P. unid. €	
191291	8	48,12	2



## Juego de Llaves combinadas, caja cartón



### COMPOSICION

8, 10, 11, 12, 13, 14, 17, 19 mm

Code	Nº Piezas	P.V.P. unid. €	
<b>191280</b>	8	<b>47,90</b>	2

## Juego de Llaves combinadas, bolsa de nylon



### COMPOSICION

todas las medidas entre 6 y 32 mm

Code	Nº Piezas	P.V.P. unid. €	
<b>191286</b>	26	<b>235,29</b>	1



### COMPOSICION

**190140:** 1/4" • 5/16" • 3/8" • 7/16" • 1/2" • 9/16" • 5/8" • 11/16"  
**190145:** 3/8" • 7/16" • 1/2" • 9/16" • 5/8" • 11/16" • 3/4" • 13/16" • 7/8" • 15/16" • 1" • 1-1/16"

Code	Nº Piezas	P.V.P. unid. €	
<b>190140</b>	8	<b>49,90</b>	1
<b>190145</b>	12	<b>98,40</b>	1

## Juego de Llaves combinadas, soporte plástico



Medida caja: 255x185x48 mm

### COMPOSICION

8, 9, 10, 11, 12, 13, 14, 15, 16, 17, 18, 19 mm

Code	Nº Piezas	P.V.P. unid. €	
<b>191285</b>	12	<b>71,35</b>	2

### COMPOSICION

8, 10, 11, 12, 13, 14, 17, 19 mm

Code	Nº Piezas	P.V.P. unid. €	
<b>191296</b>	8	<b>48,93</b>	2

**Llave de estrella acodada**

**DIN**  
838

**ACERO**  
CR-V



Aristas redondeadas

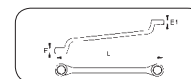

• Cromado satinado mate y cabezas pulidas

Code	mm	L mm	E mm	E1 mm	P.V.P. unid. €	
191105	6x7	170	5,5	6,2	5,41	10
191110	8x9	182	6,5	7,4	5,92	10
191115	10x11	197	8	8,5	6,32	10
191120	12x13	212	9	9,5	6,68	10
191128	13x17	245	9	11	7,25	10
191125	14x15	227	10	10,5	8,42	10
191130	16x17	245	11	11,5	8,62	10
191133	17x19	265	11,4	11,9	9,89	10
191135	18x19	265	12	12,5	9,96	10
191138	19x22	288	12,4	12,9	11,50	5
191140	20x22	287	13	13,5	11,50	5
191145	21x23	310	13	14	12,97	5
191148	22x24	310	13	14	13,32	5
191150	24x26	330	14,5	15	16,11	5
191155	24x27	330	14,5	15	16,11	5
191160	25x28	350	15	15,5	18,71	5
191165	27x29	360	16	16,5	19,86	5
191170	30x32	372	16	17	22,66	5
191172	32x36	415	16,5	17,8	35,27	2
191175	36x41	460	17,3	19,2	42,12	2
191177	46x50	526	20	22,5	68,54	2



Code	"	L mm	E mm	E1 mm	P.V.P. unid. €	
190050	1/4"x5/16"	170	4,9	5,6	5,41	1
190052	5/16"x3/8"	190	6	7,4	5,92	1
190054	3/8"x7/16"	197	7,4	7,9	6,32	1
190056	7/16"x1/2"	213	8,4	8,9	6,68	1
190058	1/2"x9/16"	228	9,4	9,9	7,25	1
190060	9/16"x5/8"	246	10,4	10,9	8,10	1
190062	5/8"x11/16"	246	10,4	10,9	8,62	1
190064	11/16"x3/4"	265	11,4	11,9	9,96	1
190066	3/4"x7/8"	288	12,4	12,9	10,82	1
190068	13/16"x7/8"	288	12,4	12,9	11,49	1
190070	13/16"x15/16"	310	13,1	13,7	12,97	1
190072	15/16"x1"	330	13,7	14,3	16,11	1
190074	1"x1-1/8"	348	14,2	14,7	18,71	1
190076	1-1/16"x1-1/4"	372	15	16	19,86	1
190078	1-1/8"x1-1/4"	372	14,8	15,8	20,66	1

**Juego de Llaves fijas, soporte plástico**



**COMPOSICION**

**191182:** 8x9, 10x11, 12x13, 14x15, 16x17, 18x19 mm  
**191180:** 6x7, 8x9, 10x11, 12x13, 14x15, 16x17, 18x19, 20x22 mm

Code	Nº Piezas	P.V.P. unid. €	
191182	6	44,77	2
191180	8	61,69	2

## Juego Llaves acodadas, bolsa de nylon



### COMPOSICION

**191181:** 6x7, 8x9, 10x11, 12x13, 14x15, 16x17, 18x19, 20x22 mm

**190090:** 1/4"x5/16" • 5/16"x3/8" • 3/8"x7/16" • 7/16"x1/2" • 1/2"x9/16" • 5/8"x11/16" • 3/4"x7/8" • 11/16"x3/4"

Code	Nº Piezas	P.V.P. unid. €	
<b>191181</b>	8	<b>61,99</b>	1
<b>190090</b>	8	<b>61,02</b>	1



### COMPOSICION

**191185:** 6x7, 8x9, 10x11, 12x13, 14x15, 16x17, 18x19, 20x22, 21x23, 24x27, 25x28, 30x32 mm

**190095:** 1/4"x5/16" • 5/16"x3/8" • 3/8"x7/16" • 7/16"x1/2" • 1/2"x9/16" • 9/16"x5/8" • 5/8"x11/16" • 3/4"x7/8" • 13/16"x7/8" • 15/16"x1" • 1-1/16"x1-1/4" • 1-1/8"x1-1/4"

Code	Nº Piezas	P.V.P. unid. €	
<b>191185</b>	12	<b>132,24</b>	1
<b>190095</b>	12	<b>127,27</b>	1



## Juego de Llaves acodadas, soporte plástico



### COMPOSICION

6x7, 8x9, 10x11, 12x13, 14x15, 16x17, 18x19, 20x22 mm

Code	Nº Piezas	P.V.P. unid. €	
<b>191190</b>	8	<b>62,07</b>	2

## Juego de Llaves acodadas, caja plástica

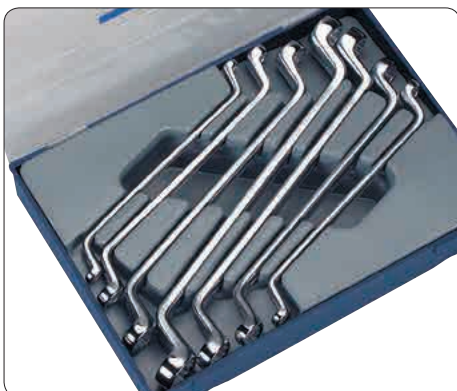

Medida caja: 255x185x48 mm



### COMPOSICION

6x7, 8x9, 10x11, 12x13, 14x15, 16x17, 18x19 mm

Code	Nº Piezas	P.V.P. unid. €	
<b>191196</b>	7	<b>50,19</b>	2



**Llave de estrella plana**

**DIN**  
837

**ACERO**  
CR-V



Aristas redondeadas

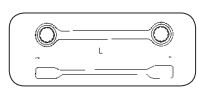
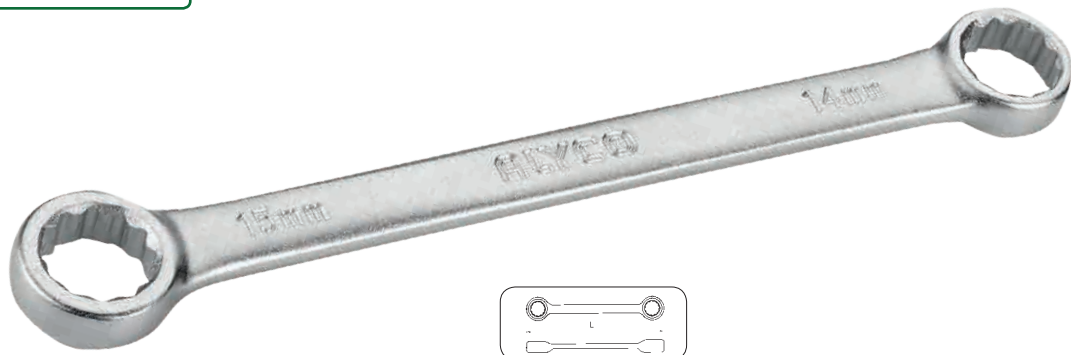

• Cromado satinado mate y cabezas pulidas

Code	Ø mm	L mm	P.V.P. unid. €	
<b>191305</b>	6x7	120	<b>6,02</b>	10
<b>191310</b>	8x9	135	<b>6,66</b>	10
<b>191315</b>	10x11	155	<b>6,81</b>	10
<b>191320</b>	12x13	165	<b>7,39</b>	10
<b>191325</b>	14x15	180	<b>8,22</b>	10
<b>191330</b>	16x17	210	<b>9,28</b>	10
<b>191335</b>	18x19	225	<b>10,14</b>	10

Code	Ø mm	L mm	P.V.P. unid. €	
<b>191340</b>	20x22	240	<b>12,03</b>	5
<b>191345</b>	21x23	255	<b>14,36</b>	5
<b>191350</b>	24x26	270	<b>15,78</b>	5
<b>191355</b>	25x28	280	<b>17,67</b>	5
<b>191357</b>	27x29	310	<b>19,13</b>	5
<b>191360</b>	30x32	330	<b>20,55</b>	5

**Juego de llaves de estrella planas, soporte plástico**



**COMPOSICION**  
6x7, 8x9, 10x11, 12x13, 14x15, 16x17, 18x19, 20x22 mm

Code	Nº Piezas	P.V.P. unid. €	
<b>191398</b>	8	<b>68,25</b>	2

**Juego de llaves de estrella planas, caja plástica**



Medida caja: 255x185x48 mm

**COMPOSICION**  
6x7, 8x9, 10x11, 12x13, 14x15, 16x17, 18x19, 20x22 mm

Code	Nº Piezas	P.V.P. unid. €	
<b>191396</b>	8	<b>66,57</b>	2

**Juego de Llaves de estrella planas, bolsa de nylon**



**COMPOSICION**  
6x7, 8x9, 10x11, 12x13, 14x15, 16x17, 18x19, 20x22, 21x23, 24x26, 25x28, 30x32 mm

Code	Nº Piezas	P.V.P. unid. €	
<b>191397</b>	12	<b>134,93</b>	1

## Llave de una boca aislada

EN  
60900

ACERO  
CR-V



Certificado VDE

### NORMA EN 60900

Herramientas aisladas utilizadas para trabajos en tensiones de hasta 1000 V en Corriente Alterna ó 1500 V en Corriente Continua



Code	mm	L mm	P.V.P. unid. €	
190157	7	88	12,89	1
190158	8	104	12,89	1
190159	9	104	14,15	1
190160	10	114	14,23	1
190161	11	124	14,84	1
190162	12	124	14,84	1
190163	13	154	16,33	1
190164	14	154	16,33	1

Code	mm	L mm	P.V.P. unid. €	
<b>Nuevo</b> 190165	15	170	17,20	1
190166	16	170	17,90	1
190167	17	170	19,41	1
190168	18	180	19,98	1
190169	19	180	20,75	1
190171	21	202	24,06	1
190172	22	202	26,87	1
190174	24	237	29,93	1

## Juego de Llaves de una boca aisladas, bolsa nylon



**Nuevo**

### COMPOSICION

8, 10, 13, 17, 19 mm

Code	Nº Piezas	P.V.P. unid. €	
190180	5	83,61	1

## Juego de Llaves de una boca aisladas, bolsa nylon



**Nuevo**

### COMPOSICION

8, 10, 11, 12, 13, 14, 15, 16, 17, 19 mm

Code	Nº Piezas	P.V.P. unid. €	
190182	10	164,72	1

**Llave estrella acodada aislada**

EN 60900

ACERO CR-V

**Nuevo**



Mango ergonómico recubierto de material antideslizante

Ángulo de la cabeza de 75 grados

**Certificado VDE**

**NORMA EN 60900**

Herramientas aisladas utilizadas para trabajos en tensiones de hasta 1000 V en Corriente Alterna ó 1500 V en Corriente Continua



Code	Ø mm	L mm	P.V.P. unid. €	
<b>190657</b>	7	149	<b>18,92</b>	1
<b>190658</b>	8	164	<b>19,20</b>	1
<b>190659</b>	9	164	<b>19,20</b>	1
<b>190660</b>	10	174	<b>19,92</b>	1
<b>190661</b>	11	184	<b>20,76</b>	1
<b>190662</b>	12	184	<b>20,76</b>	1
<b>190663</b>	13	205	<b>22,64</b>	1
<b>190664</b>	14	205	<b>22,64</b>	1

Code	Ø mm	L mm	P.V.P. unid. €	
<b>190665</b>	15	216	<b>24,00</b>	1
<b>190666</b>	16	221	<b>25,20</b>	1
<b>190667</b>	17	221	<b>25,20</b>	1
<b>190668</b>	18	237	<b>29,08</b>	1
<b>190669</b>	19	237	<b>29,08</b>	1
<b>190671</b>	21	257	<b>31,96</b>	1
<b>190672</b>	22	257	<b>31,96</b>	1
<b>190674</b>	24	284	<b>38,40</b>	1

**Juego de Llaves acodadas aisladas, bolsa nylon**

**Nuevo**



**COMPOSICION**  
8, 10, 13, 17, 19 mm

Code	Nº Piezas	P.V.P. unid. €	
<b>190675</b>	5	<b>116,04</b>	1

**Juego de Llaves acodadas aisladas, bolsa nylon**

**Nuevo**



**COMPOSICION**  
8, 10, 11, 12, 13, 14, 15, 16, 17, 19 mm

Code	Nº Piezas	P.V.P. unid. €	
<b>190676</b>	10	<b>229,40</b>	1

## Llave de carraca aislada

EN  
60900

ACERO  
CR-V



Mango ergonómico recubierto de material antideslizante

Certificado VDE

### NORMA EN 60900

Herramientas aisladas utilizadas para trabajos en tensiones de hasta 1000 V en Corriente Alterna ó 1500 V en Corriente Continua



Code	mm	L mm	P.V.P. unid. €	
190477	7	151	26,10	1
190478	8	167	27,12	1
190479	9	167	27,12	1
190480	10	178	27,73	1
190481	11	189	28,83	1
190482	12	189	28,83	1
190483	13	210	30,62	1
190484	14	210	30,62	1

Code	mm	L mm	P.V.P. unid. €	
190486	16	228	34,62	1
190487	17	228	34,62	1
190488	18	243	37,51	1
190489	19	243	37,51	1
190491	21	264	52,40	1
190492	22	264	52,40	1
190494	24	295	58,92	1

## Juego de Llaves de carraca aislada, bolsa nylon



Nuevo

### COMPOSICION

8, 10, 13, 17, 19 mm

Code	Nº Piezas	P.V.P. unid. €	
190495	5	157,60	1

## Llave fija de una boca

DIN  
894



• Acabado pavonado

Code	mm	L mm	Grosor mm	P.V.P. unid. €	
190917	17	170	6	2,49	1
190919	19	170	6	3,20	1
190922	22	193	8	3,50	1
190924	24	213	9	4,05	1
190927	27	240	9,5	4,91	1
190930	30	253	11	5,66	1
190932	32	277	11,5	6,39	1
190934	34	290	12	7,15	1
190936	36	309	12,5	9,50	1
190941	41	346	14	13,19	1

Code	mm	L mm	Grosor mm	P.V.P. unid. €	
190946	46	380	15,5	16,00	1
190950	50	415	15,5	18,68	1
190955	55	456	16,5	32,50	1
190960	60	498	17,5	33,00	1
190965	65	520	18,5	38,00	1
190970	70	560	18,5	47,00	1
190975	75	630	20,5	51,32	1
190980	80	630	21,5	59,51	1
190985	85	680	22	72,45	1

**Llave de estrella plana de golpe**

**DIN**  
7444



Aristas redondeadas

Modo de empleo

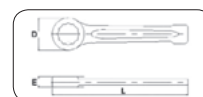
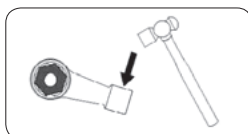

- Estrella 12 puntas
- Acabado pavonado

Code	mm	L mm	D mm	E mm	P.V.P. unid. €	
<b>191370</b>	24	168	43,4	14,8	<b>14,31</b>	1
<b>191371</b>	27	180	46	16	<b>15,83</b>	1
<b>191372</b>	30	190	51,5	17	<b>18,75</b>	1
<b>191373</b>	32	190	54	17	<b>20,16</b>	1
<b>191374</b>	36	205	58,5	18,5	<b>23,31</b>	1
<b>191375</b>	38	228	64,6	20,1	<b>28,85</b>	1
<b>191376</b>	41	230	65	20	<b>31,65</b>	1
<b>191377</b>	46	240	73,5	22	<b>34,54</b>	1
<b>191378</b>	50	253	78,5	24	<b>40,89</b>	1
<b>191379</b>	55	266	85	25	<b>51,06</b>	1

Code	mm	L mm	D mm	E mm	P.V.P. unid. €	
<b>191381</b>	60	280	92	26	<b>59,79</b>	1
<b>191382</b>	65	300	102	30	<b>70,19</b>	1
<b>191383</b>	70	330	110	33	<b>91,65</b>	1
<b>191384</b>	75	330	110	33	<b>94,76</b>	1
<b>191385</b>	80	340	118	34	<b>124,78</b>	1
<b>191386</b>	85	355	130	36	<b>154,96</b>	1
<b>191387</b>	90	390	142	39	<b>175,74</b>	1
<b>191388</b>	95	390	142	39	<b>187,85</b>	1
<b>191389</b>	100	420	155	43	<b>278,67</b>	1

**Llave fija de golpe**

**DIN**  
133



Modo de empleo

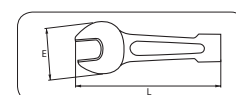
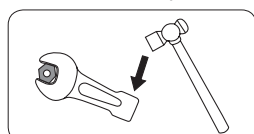

- Acabado pavonado

Code	mm	L mm	E mm	P.V.P. unid. €	
<b>190824</b>	24	177	52,5	<b>14,36</b>	1
<b>190827</b>	27	180	56	<b>15,86</b>	1
<b>190830</b>	30	190	62	<b>18,59</b>	1
<b>190832</b>	32	190	62	<b>20,20</b>	1
<b>190836</b>	36	215	74	<b>23,55</b>	1
<b>190838</b>	38	215	74	<b>28,72</b>	1
<b>190841</b>	41	235	86	<b>31,24</b>	1
<b>190846</b>	46	255	96	<b>34,61</b>	1
<b>190850</b>	50	275	105	<b>40,76</b>	1
<b>190855</b>	55	300	115	<b>50,88</b>	1
<b>190860</b>	60	320	126	<b>59,75</b>	1
<b>190865</b>	65	343	138	<b>69,53</b>	1
<b>190870</b>	70	375	154	<b>91,67</b>	1
<b>190875</b>	75	375	154	<b>94,66</b>	1
<b>190880</b>	80	400	174	<b>123,31</b>	1
<b>190885</b>	85	400	174	<b>155,49</b>	1

## Llave acodada con carraca reversible

ACERO  
CR-V

Ambas bocas  
acodadas  
y reversibles



Carraca  
72 dientes



Acodado de 15° en la cabeza

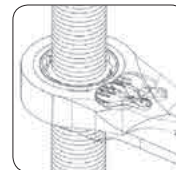

Sistema de carraca que permite trabajar a lo largo de los espárragos y varillas roscadas sin necesidad de retirar la llave

Adaptadores acoplables en pie de página

Code	mm	L mm	P.V.P. unid. €	
<b>191600</b>	8x9	128	<b>17,87</b>	5
<b>191605</b>	10x11	150	<b>19,14</b>	5
<b>191610</b>	12x13	170	<b>20,33</b>	5
<b>191615</b>	14x15	190	<b>22,34</b>	5
<b>191620</b>	16x18	230	<b>25,56</b>	5
<b>191625</b>	17x19	230	<b>27,78</b>	5

## Juego de Llaves acodadas con carraca, soporte de plástico



**Nuevo**

### COMPOSICION

8x9, 10x11, 12,x13, 14x15, 16x18, 17x19 mm.

Code	Nº Piezas	P.V.P. unid. €	
<b>191627</b>	6	<b>135,28</b>	1

## Juego de Llaves acodadas con carraca, caja plástica



Medida caja: 255x185x48 mm

### COMPOSICION

8x9, 10x11, 12x13, 14x15, 16x18, 17x19 mm  
3 adaptadores para vasos de 1/2" 191882, 1/4" 191880, 3/8" 191881

Code	Nº Piezas	P.V.P. unid. €	
<b>191650</b>	9	<b>148,00</b>	1

## Adaptadores para vasos y puntas



191882

191881

191880

191885

Code	Para	Con llave mm	P.V.P. unid. €	
<b>191880</b>	Vasos 1/4"	10	<b>4,98</b>	5
<b>191881</b>	Vasos 3/8"	13	<b>5,53</b>	5
<b>191882</b>	Vasos 1/2"	19	<b>6,46</b>	5
<b>191885</b>	Puntas 1/4"	10	<b>1,88</b>	5

**Llave combinada con carraca reversible**

ACERO  
CR-V



**Adaptadores acoplables en página anterior**

- Acodado de 15° en la cabeza
- Carraca reversible de 72 dientes
- Cromado satinado mate y cabezas pulidas

Code	mm	L mm	P.V.P. unid. €	
191805	8	136	11,89	5
191810	9	143	11,95	5
191815	10	159	12,00	5
191820	11	168	12,34	5
191825	12	174	13,19	5
191830	13	180	14,50	5
191835	14	190	15,43	5

Code	mm	L mm	P.V.P. unid. €	
191840	15	200	15,81	5
191845	16	216	16,72	5
191850	17	233	17,57	5
191855	18	239	18,88	5
191860	19	248	19,37	5
191862	21	284	22,08	5
191864	22	284	23,37	5

Code	mm	L mm	P.V.P. unid. €	
<b>Nuevo</b> 191865	23	285	25,46	5
191866	24	324	26,17	5
<b>Nuevo</b> 191891	26	325	30,59	5
191868	27	359	36,74	5
<b>Nuevo</b> 191869	28	359	41,57	5
191870	30	425	44,88	5
191872	32	425	48,52	5

**Juego de Llaves combinadas con carraca, soporte plástico**



**Nuevo**

**COMPOSICION**  
8, 10, 13, 17, 19 mm

Code	Nº Piezas	P.V.P. unid. €	
191874	5	75,33	1

**Juego de Llaves L combinadas con carraca, soporte plástico**



Detalle 191876

**COMPOSICION**  
191876: 8, 10, 11, 12, 13, 14, 17, 19 mm  
191877: 8, 9, 10, 11, 12, 13, 14, 15, 16, 17, 18, 19 mm

Code	Nº Piezas	P.V.P. unid. €	
191876	8	116,29	1
<b>Nuevo</b> 191877	12	167,70	1

## Llave combinada flexible con carraca

ACERO  
CR-V

Carraca  
72 dientes



Cromado satinado  
mate y cabezas pulidas

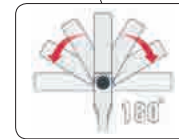

Cabeza flexible.  
Posibilidad de girar  
la cabeza a cualquier  
ángulo en un  
intervalo de 180°

Ver adaptadores en pág. 92

Code	mm	L mm	P.V.P. unid. €	
<b>191905</b>	8	136	<b>14,00</b>	5
<b>Nuevo 191907</b>	9	143	<b>14,50</b>	5
<b>191910</b>	10	159	<b>15,44</b>	5
<b>191915</b>	11	168	<b>15,86</b>	5
<b>191920</b>	12	174	<b>16,50</b>	5
<b>191925</b>	13	180	<b>17,00</b>	5
<b>Nuevo 191926</b>	14	193	<b>17,50</b>	5
<b>Nuevo 191927</b>	15	200	<b>18,00</b>	5
<b>Nuevo 191928</b>	16	216	<b>19,00</b>	5

Code	mm	L mm	P.V.P. unid. €	
<b>191930</b>	17	233	<b>20,00</b>	5
<b>Nuevo 191932</b>	18	239	<b>21,00</b>	5
<b>191935</b>	19	248	<b>24,90</b>	5
<b>Nuevo 191937</b>	21	285	<b>26,90</b>	5
<b>Nuevo 191939</b>	22	285	<b>26,90</b>	5
<b>Nuevo 191941</b>	24	325	<b>32,03</b>	5
<b>Nuevo 191943</b>	27	359	<b>45,71</b>	5
<b>Nuevo 191945</b>	30	425	<b>55,98</b>	5
<b>Nuevo 191947</b>	32	425	<b>55,98</b>	5

## Juego de Llaves combinadas flexibles con carraca



### COMPOSICION

8, 10, 13, 17, 19 mm

Code	Nº Piezas	P.V.P. unid. €	
<b>191950</b>	5	<b>91,34</b>	1

## Juego de Llaves combinadas flexibles con carraca



191952



191951



Detalle 191951

### COMPOSICION

**191951:** 8, 10, 11, 12, 13, 14, 17, 19 mm

**191952:** 8, 9, 10, 11, 12, 13, 14, 15, 16, 17, 18, 19 mm

Code	Nº Piezas	P.V.P. unid. €	
<b>191951</b>	8	<b>141,20</b>	1
<b>Nuevo 191952</b>	12	<b>199,20</b>	1



**Llave con carraca reversible 4 en 1**

ACERO  
CR-V

Carraca  
72 dientes



Terminación satinado mate



Cada boca se puede utilizar con dos medidas de tuerca diferentes

Code	boca1 mm	boca2 mm	L mm	P.V.P. unid. €	
<b>191630</b>	8x10	12x13	160	<b>19,03</b>	2
<b>191632</b>	9x11	14x15	180	<b>22,27</b>	2
<b>191634</b>	16x17	18x19	225	<b>23,61</b>	2
<b>191636</b>	10x13	17x19	225	<b>23,61</b>	2

**Juego de Llaves con carraca 4 en 1, bolsa de nylon**

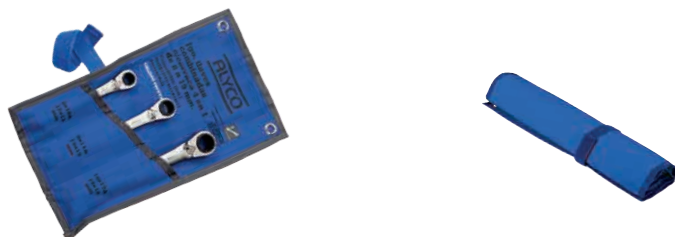

**COMPOSICION**

191630, 191632, 191634

Code	Nº Piezas	P.V.P. unid. €	
<b>191640</b>	3	<b>65,53</b>	1

**Llave de Vaso articulada**

ACERO  
CR-V



Aristas redondeadas



- Vaso con boca de 12 caras
- Terminación cromado
- Posibilidad de giro del vaso en 180°

Code	mm	L mm	D1 mm	D2 mm	P.V.P. unid. €	
<b>191652</b>	6x7	182	9,5	11	<b>10,86</b>	2
<b>191654</b>	8x9	182	13	14	<b>10,86</b>	2
<b>191656</b>	10x11	198	15	16	<b>11,18</b>	2
<b>191658</b>	12x13	220	18	19	<b>13,29</b>	2
<b>191660</b>	14x15	240	20	22	<b>14,93</b>	2
<b>191662</b>	16x17	260	24	24	<b>17,09</b>	2
<b>191664</b>	18x19	275	26	26	<b>19,86</b>	2
<b>191666</b>	20x22	302	28	31	<b>25,04</b>	2
<b>191668</b>	21x23	307	29	33	<b>26,14</b>	2
<b>191670</b>	24x27	333	33	36,6	<b>28,94</b>	2
<b>191672</b>	30x32	349	39,7	41,7	<b>33,26</b>	2

**Juego de Llaves de Vaso articuladas, bolsa de nylon**



**COMPOSICION**

6x7, 8x9, 10x11, 12x13, 14x15, 16x17, 18x19, 20x22 mm

Code	Nº Piezas	P.V.P. unid. €	
<b>191675</b>	8	<b>123,12</b>	1

## Llave de Tubo hexagonal forjada

ACERO  
CR-V

Terminación:  
• Cabezas pulidas  
• Cromado satinado



Code	mm	L mm	D mm	D1 mm	P.V.P. unid. €	
191405	6x7	105	10	11	8,85	10
191410	8x9	110	12,5	13,5	8,98	10
191415	10x11	120	15	16	9,47	10
191420	12x13	140	17,5	19	11,11	10
191425	14x15	145	20	21,5	12,35	10
191430	16x17	155	22,5	24	14,47	10
191435	18x19	165	25,5	26	17,34	10

Code	mm	L mm	D mm	D1 mm	P.V.P. unid. €	
191440	20x22	175	28	30	19,79	5
191445	21x23	185	29	31	22,03	5
191450	24x26	195	32,5	36,5	23,57	5
191452	24x27	195	32,5	36,5	23,57	5
191455	25x28	205	34	37	26,44	5
191457	27x29	210	36	39	30,54	5
191460	30x32	210	40	42,5	34,70	5

Se suministra con colgador

## Juego de Llaves de Tubo forjadas, soporte plástico



### COMPOSICION

6x7, 8x9, 10x11, 12x13, 14x15, 16x17, 18x19 + volvedor

Code	Nº Piezas	P.V.P. unid. €	
191485	8	84,87	1

## Juego de Llaves de Tubo forjadas, módulo



Medida caja: 255x185x48 mm

### COMPOSICION

6x7, 8x9, 10x11, 12x13, 14x15, 16x17, 18x19, 20x22 + volvedor

Code	Nº Piezas	P.V.P. unid. €	
191480	9	107,21	1

## Juego de Llaves de Tubo forjadas, bolsa de nylon



### COMPOSICION

6x7, 8x9, 10x11, 12x13, 14x15, 16x17, 18x19, 20x22 mm + volvedor

Code	Nº Piezas	P.V.P. unid. €	
191470	9	107,04	1



### COMPOSICION

6x7, 8x9, 10x11, 12x13, 14x15, 16x17, 18x19, 20x22, 21x23, 24x27, 25x28, 30x32 mm + dos volvedores

Code	Nº Piezas	P.V.P. unid. €	
191475	14	220,87	1

**Llave de Tubo estampada**

**DIN**  
896

**ACERO**  
CR-V

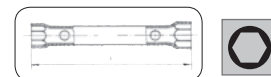

- Cuerpo redondo y cabeza hexagonal para giro con llave
- Acabado satinado mate
- Agujero para accionamiento con volvedor

Code	mm	L mm	P.V.P. unid. €	
<b>191505</b>	6x7	110	<b>2,89</b>	10
<b>191510</b>	8x9	110	<b>3,02</b>	10
<b>191515</b>	10x11	120	<b>3,48</b>	10
<b>191520</b>	12x13	140	<b>4,15</b>	10
<b>191525</b>	14x15	140	<b>4,46</b>	10
<b>191530</b>	16x17	150	<b>4,82</b>	10
<b>191535</b>	18x19	160	<b>6,08</b>	10
<b>191540</b>	20x22	170	<b>7,74</b>	5

Code	mm	L mm	P.V.P. unid. €	
<b>191545</b>	21x23	170	<b>8,08</b>	5
<b>191550</b>	24x26	190	<b>10,89</b>	5
<b>191552</b>	24x27	190	<b>10,89</b>	5
<b>191555</b>	25x28	190	<b>11,80</b>	5
<b>191557</b>	27x29	195	<b>11,93</b>	5
<b>191560</b>	30x32	210	<b>12,14</b>	5
<b>191565</b>	36x41	210	<b>16,30</b>	5

Se suministra con colgador

**Juego de Llaves de Tubo estampadas, bolsa de nylon**



**COMPOSICION**

6x7, 8x9, 10x11, 12x13, 14x15, 16x17, 18x19, 20x22 mm + volvedor

Code	Nº Piezas	P.V.P. unid. €	
<b>191570</b>	9	<b>39,82</b>	1



**COMPOSICION**

6x7, 8x9, 10x11, 12x13, 14x15, 16x17, 18x19, 20x22, 21x23, 24x27, 25x28, 30x32 mm + dos volvedores

Code	Nº Piezas	P.V.P. unid. €	
<b>191575</b>	14	<b>82,03</b>	1

**Llave de cabina**



- 5-6-8 mm
- 9 mm
- ⊕ Punta PH2
- △ 9 mm
- Adapt. 1/4"
- ⊖ Plana 4,5 mm

Code	Medida mm	P.V.P. unid. €	
<b>191990</b>	60	<b>13,90</b>	6

Se suministra en blister

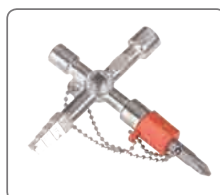

Ambas llaves de cabina incluyen un adaptador de plástico para puntas



- 5-7-8 mm
- ◄ 4-10 mm
- ⊕ Punta PH2
- △ 10 mm
- Adapt. 1/4"
- ⊖ Plana 4,5 mm

Code	Medida mm	P.V.P. unid. €	
<b>191995</b>	70	<b>13,90</b>	6

Se suministra en blister

## Llave de Pipa

DIN  
691

ACERO  
CR-V

Agujero pasante

**BOCAS 6x6 CARAS**



Terminación satinado mate

Llave especial para trabajos pesados de grandes esfuerzos

Bocas pulidas

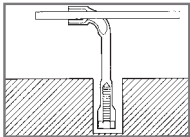

Permite utilizar barras para aprietes más fuertes

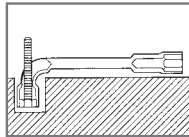

Permite atar tuercas sobre espárragos pasantes

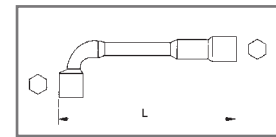

Code	mm	L mm	P.V.P. unid. €	
175001	6	105	7,62	5
175002	7	105	7,86	5
175003	8	115	8,69	5
175004	9	122	9,20	5
175005	10	130	9,73	5
175006	11	136	9,81	5
175007	12	145	10,48	5
175008	13	152	11,26	5
175009	14	160	11,99	5
175010	15	170	13,16	5
175011	16	178	14,38	5
175012	17	187	15,14	5
175013	18	195	16,11	5
175014	19	205	16,56	5

Code	mm	L mm	P.V.P. unid. €	
175015	20	212	18,07	5
175016	21	225	20,16	5
175017	22	225	21,58	5
175018	23	240	23,28	5
175019	24	250	23,61	1
175020	25	270	24,38	1
175021	26	270	31,04	1
175022	27	280	31,78	1
175023	28	290	33,08	1
175024	29	300	36,24	1
175025	30	310	41,25	1
175026	32	330	42,62	1
175027	36	355	57,51	1

## Juego de llaves de Pipa



### COMPOSICION

10, 11, 12, 13, 17, 19 mm

Code	Nº Piezas	P.V.P. unid. €	
175030	6	73,26	1

## Desmontador

ACERO  
CR-V

**Para desmontado de neumáticos**

- Terminación cromado
- Curvado para facilitar el desmontaje



Code	L mm	A mm	P.V.P. unid. €	
118050	215	16	4,50	1
118052	350	24	9,06	1
118054	500	28	16,50	1

## Llave para ruedas

ACERO  
CR-V



- Mango moleteado
- Terminación satinado mate

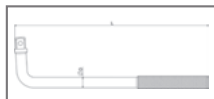

Code	"	L mm	L "	Ø mm	P.V.P. unid. €	
<b>191492</b>	1/2	300	12	14	<b>11,00</b>	1
<b>191494</b>	3/4	300	12	20	<b>19,56</b>	1
<b>191496</b>	3/4	450	18	20	<b>28,80</b>	1

## Llave en cruz

ACERO  
CR-V

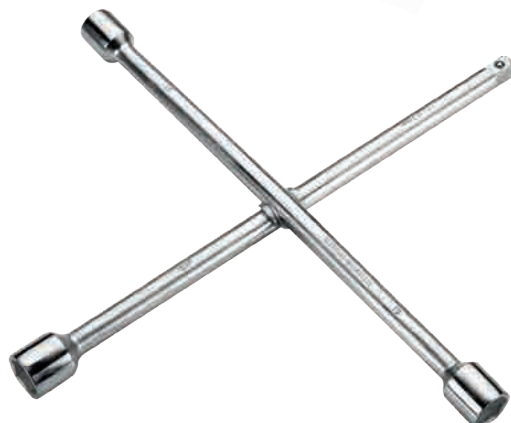

### TAMAÑO DE BOCAS

Code	ØA mm	ØB mm	ØC mm	D "
191498	17	19	22	1/2
191499	24	27	32	3/4

- Templado a 45 ÷ 50 HRC
- Terminación satinado mate y bocas pulidas
- Soldadura reforzada. Preparada para trabajos pesados

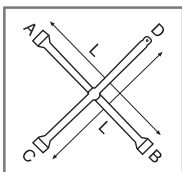

Code	L mm	L "	P.V.P. unid. €	
<b>191498</b>	375	15	<b>24,95</b>	1
<b>191499</b>	625	25	<b>73,87</b>	1

## Llave magnética para bujías con mango en T

ACERO  
CR-V



Con cuadradillo de 3/8" para accionar con llave de carraca

- Presentación cromado
- Vaso magnético y hexagonal
- Fijación del vaso a diferentes ángulos



Code	Ø mm	L mm	S mm	D mm	P.V.P. unid. €	
<b>191695</b>	16	300	200	22	<b>21,61</b>	1
<b>191697</b>	21	300	200	28	<b>22,44</b>	1

## Llave de Vaso con mango en T

DIN  
3112

ACERO  
CR-V



Con cuadradillo de 3/8" para accionar con llave de carraca

- Vaso de 6 caras
- Presentación cromado
- Con articulación universal para poder ser inclinado a diferentes ángulos

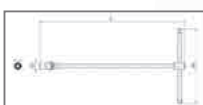

Articulación universal

Code	Ø mm	L mm	S mm	D mm	P.V.P. unid. €	
<b>191682</b>	8	390	200	12,5	<b>19,86</b>	1
<b>191684</b>	10	500	200	15	<b>21,05</b>	1
<b>191686</b>	12	500	200	17,5	<b>21,05</b>	1
<b>191688</b>	13	500	200	18	<b>21,05</b>	1
<b>191690</b>	17	500	200	24	<b>22,06</b>	1
<b>191692</b>	19	500	200	26	<b>23,47</b>	1

## Llave Ajustable de moleta lateral

DIN  
3117

ACERO  
CR-V



Perfil más estrecho de la cabeza para acceder a lugares reducidos



Apertura de la boca que excede las normas DIN

Code	L mm	C mm	C (DIN) mm	D mm
172270	150	23,9	19	23
172271	200	28,6	24	26,5
172272	250	32,8	28	31
172273	300	38,1	34	39
172274	400	50	43	48
172275	500	62	52	65



Bocas pulidas

Mango redondeado ancho

Cabeza milimetrada por ambos lados para ajustes rápidos

15°

Ángulo de la cabeza de 15° para un manejo más ergonómico y preciso



Sistema de apertura mediante moleta lateral

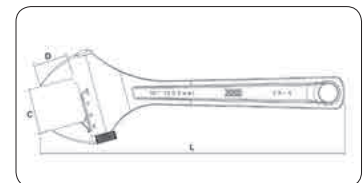

Code	L mm	L "	P.V.P. unid. €	
<b>172270</b>	150	6	<b>21,43</b>	6
<b>172271</b>	200	8	<b>23,73</b>	6
<b>172272</b>	250	10	<b>29,33</b>	6
<b>172273</b>	300	12	<b>37,51</b>	6
<b>172274</b>	400	16	<b>60,80</b>	4
<b>172275</b>	500	20	<b>103,62</b>	2

Se suministra en colgador

## Llave Ajustable de moleta central

DIN  
3117

ACERO  
CR-V

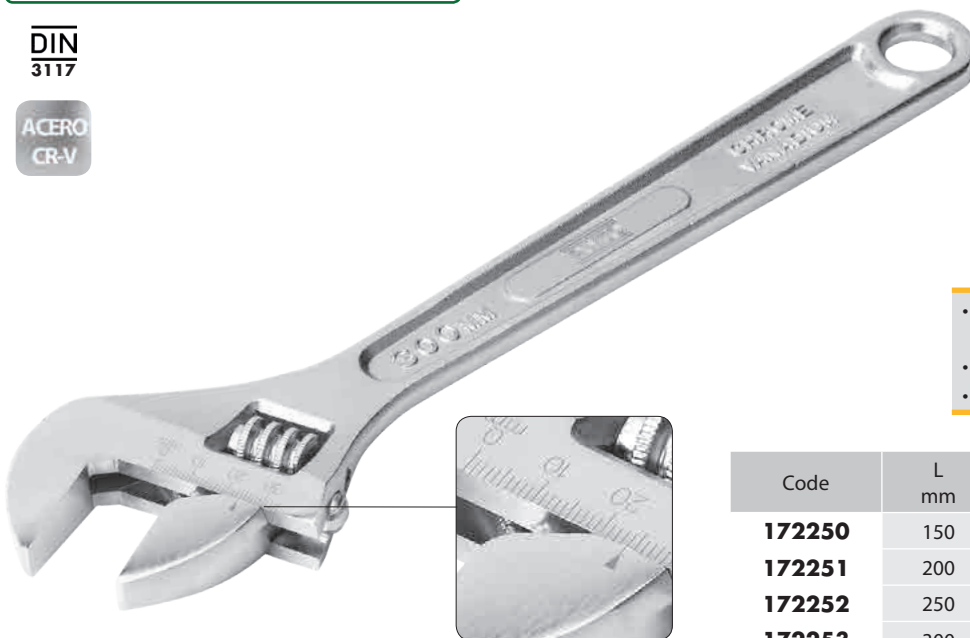

Cabeza milimetrada para ajustes rápidos

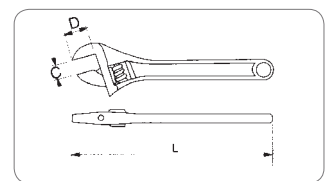

- Apertura máxima de las bocas y profundidad exceden de las normas DIN
- Cabeza graduada para preajustes
- Terminación cromado brillante

Code	L mm	L "	C mm	D mm	P.V.P. unid. €	
<b>172250</b>	150	6	20	18	<b>12,67</b>	6
<b>172251</b>	200	8	24	25	<b>14,69</b>	6
<b>172252</b>	250	10	29	29	<b>18,38</b>	6
<b>172253</b>	300	12	34	32	<b>23,70</b>	6
<b>172254</b>	380	15	43	44	<b>42,81</b>	2
<b>172255</b>	450	18	53	53	<b>64,66</b>	2
<b>172256</b>	600	24	70	62	<b>124,99</b>	1

Se suministra en colgador

**Nuevo**

**Llave Ajustable de boca reversible**

**DIN**  
3117

**ACERO**  
CR-V

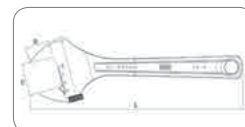

Apertura de la boca que excede un 50% las normas DIN

Code	L mm	C mm	C (DIN) mm	D mm
172265	200	38	24	32

**BOCA REVERSIBLE**



**USO CON TUBO**

**USO CON TUERCA**

Code	L mm	L "	P.V.P. unid. €	
<b>172265</b>	200	8	<b>24,80</b>	6

Se suministra en blister

**Llave Ajustable de apertura extra**

**ACERO**  
CR-V



- 1 Perfil estrecho de las bocas para lugares de difícil acceso. Pares de torsión muy superiores a la norma DIN
- 2 Bocas muy profundas, altura de boca aproximadamente un 30% mayor que la norma DIN
- 3 Ángulo de 15° que permite una alineación entre la llave y la tuerca para aprietes rápidos, precisos y ergonómicos
- 4 Llave ajustable de bocas de gran apertura. Aproximadamente un 55% mayor que la norma DIN

**COMPARATIVA APERTURA Y PROFUNDIDAD DE BOCAS**

Code	C	C (DIN)	D	D (DIN)
172280	34	19	28,9	17,5
172281	38	24	32,4	22
172282	50	28	41	26
172283	60	34	55,7	29

Comparación con los valores marcados por la norma DIN

Code	L mm	L "	P.V.P. unid. €	
<b>172280</b>	150	6	<b>19,69</b>	6
<b>172281</b>	200	8	<b>22,60</b>	6
<b>172282</b>	250	10	<b>27,94</b>	5
<b>172283</b>	300	12	<b>35,00</b>	5

Se suministra en blister

## Llave Ajustable corta de gran apertura

ACERO  
CR-V

30% MAS LIGERA



### APERTURA Y PROFUNDIDAD DE BOCAS

Code	C	D
172286	32	30
172288	43	41



Evita el redondeo de tuercas

Gran apertura, 50% mayor que la norma DIN

Gran profundidad de bocas

Code	L mm	L "	P.V.P. unid. €	
<b>172286</b>	140	5,5	<b>18,80</b>	6
<b>172288</b>	160	6,3	<b>24,40</b>	6

Se suministra en blister

## Llave Ajustable de carraca

DIN  
3117

ACERO  
CR-V



Función carraca

### DOBLE FUNCION:

- Standard. Botón a izquierda
- Carraca. Botón a derecha

### APERTURA Y PROFUNDIDAD DE BOCAS

Code	C	D
172277	29	26

Code	L mm	L "	P.V.P. unid. €	
<b>172277</b>	200	8	<b>23,26</b>	3

Se suministra en colgador

## Llave Ajustable aislada

DIN  
3117

ACERO  
CR-V



Certificado VDE



- Mango recubierto de material aislante
- Cabeza graduada para preajustes
- Marcado indeleble del certificado

Code	L mm	L "	P.V.P. unid. €	
<b>172295</b>	200	8	<b>38,05</b>	2
<b>172296</b>	250	10	<b>47,00</b>	2



**Llave articulada de pivote fijo**

ACERO  
CR-V

Cada llave es adecuada para  
diversos diámetros de tuerca

- Llave forjada
- Terminación cromado satinado



Code	Nº	Ø mm	L mm	P.V.P. unid. €	
<b>145101</b>	0	15-35	168	<b>21,08</b>	6
<b>145102</b>	1	35-50	202	<b>22,95</b>	6
<b>145103</b>	2	50-80	280	<b>31,49</b>	6
<b>145104</b>	3	80-120	345	<b>40,81</b>	4
<b>145105</b>	4	120-180	492	<b>56,13</b>	2

**Llave articulada de pivote con tornillo**

ACERO  
CR-V

Cada llave es adecuada para  
diversos diámetros de tuerca

- Llave forjada
- Terminación cromado satinado



Code	Nº	Ø mm	L mm	D mm	P.V.P. unid. €	
<b>145106</b>	0	15-35	168	3	<b>22,51</b>	6
<b>145107</b>	1	35-50	202	4	<b>24,88</b>	6
<b>145108</b>	2	50-80	280	5	<b>32,40</b>	6
<b>145109</b>	3	80-120	345	6	<b>43,49</b>	4
<b>145110</b>	4	120-180	492	8	<b>58,20</b>	2

**Tornillo de repuesto para Llaves articuladas**



Code	Nº	D mm	P.V.P. unid. €	
<b>164021</b>	0	3	<b>2,70</b>	6
<b>164022</b>	1	4	<b>3,10</b>	6
<b>164023</b>	2	5	<b>3,84</b>	6
<b>164024</b>	3	6	<b>4,24</b>	6
<b>164025</b>	4	8	<b>5,21</b>	6

**Llave de estrella acodada con trinquete reversible**



Code	Ø mm	L mm	P.V.P. unid. €	
<b>191710</b>	7x8	108	<b>11,45</b>	3
<b>191720</b>	10x11	175	<b>14,45</b>	3
<b>191730</b>	12x13	175	<b>18,26</b>	3
<b>191740</b>	14x15	175	<b>18,98</b>	3
<b>191750</b>	16x18	203	<b>20,53</b>	3
<b>191760</b>	17x19	203	<b>21,11</b>	3

## Llave Dinamométrica con visor

DIN 6789

Precisión del par  $\pm 3\%$



Certificado de calibración y número de serie individual

Para aprietes a derechas

Mango ergonómico antideslizante



Instrucciones de uso



Ventana con doble escala N.m/Lb.Ft

Code	"	Nm	Capacidad Kg	Lb-ft	L mm	Precisión Nm	Carraca dientes
192920	1/4	2-25	0,2-2,5	1,5-18	300	0,1	24
192930	3/8	5-50	0,5-5	3,5-37	330	0,25	24
192898	1/2	10-100	1-10	8-75	400	0,5	32
192900	1/2	20-200	2-20	10-150	500	1,0	32
192910	1/2	60300	6-30	45-220	635	1,0	32
192940	3/4	80-400	8-40	66-290	610	2,0	24
192945	3/4	150-800	15-80	129-572	1250	2,0	24



Presentación en estuche individual

Code	"	Capacidad Nm	P.V.P. unid. €	
<b>192920</b>	1/4	2-25	<b>131,28</b>	1
<b>192930</b>	3/8	5-50	<b>147,75</b>	1
<b>192898</b>	1/2	10-100	<b>153,12</b>	1
<b>192900</b>	1/2	20-200	<b>163,32</b>	1
<b>192910</b>	1/2	60-300	<b>211,13</b>	1
<b>192940</b>	3/4	80-400	<b>350,10</b>	1
<b>192945</b>	3/4	150-800	<b>612,36</b>	1

Recambios de mecanismo disponibles en pág. 105

### AJUSTE DE PAR



## Llave Dinamométrica 1"

DIN 6789

Precisión del par  $\pm 3\%$



Certificado de calibración individual

Carraca 24 dientes



Code	"	Capacidad Nm	Kgm	Lb-ft	L mm	Precisión Nm
192948	1	300-1500	30-150	258-1070	1850	10,0

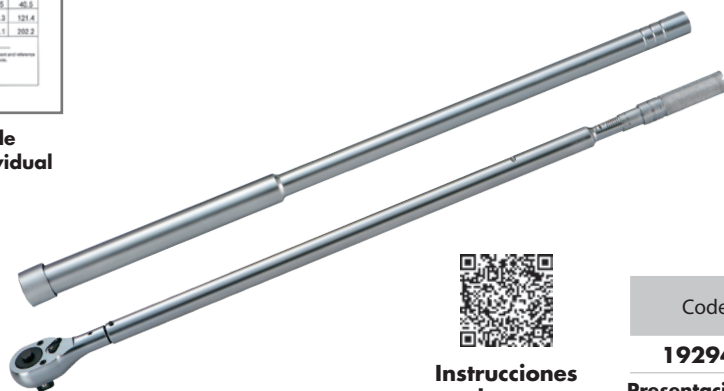

Instrucciones de uso

- Número de serie y certificado de calibración individual
- Escala impresa de N.m/Lb.Ft.
- Diseño especial para ajuste rápido y sin esfuerzo del par de apriete

Code	"	Capacidad Nm	P.V.P. unid. €	
<b>192948</b>	1	300-1500	<b>1.352,00</b>	1

Presentación en estuche individual

## Mini llave dinamométrica

DIN 6789

Precisión del par  $\pm 3\%$

Escala impresa N.m y Lb.Ft



Certificado de calibración individual

Code	"	Carraca dientes	Capacidad Nm Kgm		L mm	Precisión Nm	P.V.P. unid. €	
<b>192895</b>	1/4	64	1-6	0.1-0.6	210	0,05	<b>117,51</b>	1

## Llave dinamométrica de disparo Slipper

DIN 6789

Precisión del par  $\pm 4\%$  en 194215/ 194220  
Precisión del par  $\pm 6\%$  en 194200/ 194205

**Nuevo**



Certificado de calibración individual



Code	"	Capacidad Nm	Kgm	Lb-ft	L mm	Precisión Nm	Carraca dientes
194200	1/4	1-5	0,1-0,5	0,7-3,7	260	0,05	36
194205	1/4	2-10	0,2-1	1,5-7,4	260	0,1	36
194215	1/4	5-25	0,5-2,5	3,5-18	320	0,1	36
194220	3/8	10-60	1-6	8-44	355	0,25	48

### MECANISMO DE DESLIZAMIENTO

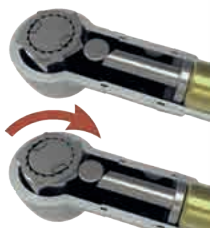

NO ES POSIBLE REALIZAR UN SOBREPRIETE



Instrucciones de uso

Code	"	Capacidad Nm	P.V.P. unid. €	
<b>194200</b>	1/4	1-5	<b>159,00</b>	1
<b>194205</b>	1/4	2-10	<b>168,00</b>	1
<b>194215</b>	1/4	5-25	<b>173,00</b>	1
<b>194220</b>	3/8	10-60	<b>208,00</b>	1

## Kit de reparación de llaves dinamométricas

**Nuevo**



Para llaves dinamométricas con visor

Code	"	Para llave	P.V.P. unid. €	
<b>199168</b>	1/4	192920	<b>9,00</b>	1
<b>199170</b>	3/8	192930	<b>10,00</b>	1
<b>199172</b>	1/2	192898	<b>12,50</b>	1
<b>199174</b>	1/2	192900/ 192910	<b>17,50</b>	1
<b>199176</b>	3/4	192940	<b>23,50</b>	1
<b>199178</b>	3/4	192945	<b>40,00</b>	1



Para llaves dinamométricas de disparo slipper

Code	"	Para llave	P.V.P. unid. €	
<b>199166</b>	1/4	194200/ 194205	<b>60,00</b>	1
<b>199167</b>	1/4	194215	<b>70,00</b>	1
<b>199171</b>	3/8	194220	<b>75,00</b>	1

## Mango dinamométrico para cabezas intercambiables

- Para cabezas intercambiables de 9x12 y 14x18 mm
- Botón para soltado fácil de la cabeza
- Mango ergonómico y confortable
- Ajuste rápido y preciso del par en el mango

**Precisión del par  $\pm 3\%$   
Aprietas a derecha e izquierda**



Escala impresa  
N.m y Lb.Ft



**Certificado de  
calibración individual**



Instrucciones  
de uso



Presentación en  
estuche individual

Code	∅ mm	Capacidad Nm	Kgm	Precisión Nm	P.V.P. unid. €	
<b>194100</b>	9x12	4-20	0,4-2	0,1	<b>127,25</b>	1
<b>194105</b>	9x12	20-100	2-10	0,5	<b>158,73</b>	1
<b>194110</b>	14x18	40-200	4-20	1,0	<b>162,52</b>	1
<b>194115</b>	14x18	50-350	5-35	2,0	<b>170,57</b>	1

## Cabeza intercambiable de carraca

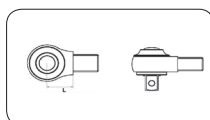

- Fabricado en Acero Cromo-Vanadio
- Cabeza con mecanismo de 72 dientes

Code	∅ mm	L mm	Cabeza	P.V.P. unid. €	
<b>194180</b>	9x12	46	1/4"	<b>29,94</b>	1
<b>194182</b>	9x12	60	1/2"	<b>38,50</b>	1
<b>194184</b>	14x18	70	1/2"	<b>39,63</b>	1

## Cabeza intercambiable, boca abierta

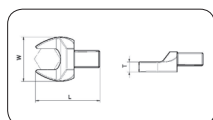

## Cabeza intercambiable, boca estrella

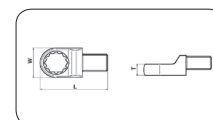

Code	∅ mm	∅ mm	L x W x T mm	P.V.P. unid. €	
<b>194120</b>	9x12	10	40x25x6	<b>16,85</b>	1
<b>194121</b>	9x12	11	40x25x6	<b>16,85</b>	1
<b>194122</b>	9x12	12	40x27x6	<b>16,85</b>	1
<b>194123</b>	9x12	13	40x29x6	<b>16,85</b>	1
<b>194124</b>	9x12	14	44x32x8	<b>16,85</b>	1
<b>194127</b>	9x12	17	44x38x8	<b>18,18</b>	1
<b>194129</b>	9x12	19	45x42x8	<b>18,18</b>	1
<b>194133</b>	14x18	13	58x30x7	<b>21,03</b>	1
<b>194137</b>	14x18	17	60x38x9	<b>21,03</b>	1
<b>194139</b>	14x18	19	60x41x9	<b>21,03</b>	1
<b>194142</b>	14x18	22	62x48x11	<b>23,55</b>	1
<b>194144</b>	14x18	24	64x51x11	<b>27,05</b>	1
<b>194145</b>	14x18	27	70x60x13,5	<b>30,72</b>	1
<b>194146</b>	14x18	30	71x64x13,5	<b>30,72</b>	1
<b>194147</b>	14x18	32	73x66x13,5	<b>30,72</b>	1
<b>194148</b>	14x18	36	75x68x13,5	<b>30,72</b>	1
<b>194149</b>	14x18	41	80x83x13,5	<b>30,72</b>	1

Code	∅ mm	∅ mm	L x W x T mm	P.V.P. unid. €	
<b>194150</b>	9x12	10	42x20x8	<b>16,28</b>	1
<b>194151</b>	9x12	11	44x21x8	<b>16,28</b>	1
<b>194152</b>	9x12	12	44x22x12,2	<b>16,28</b>	1
<b>194153</b>	9x12	13	44x22x12,2	<b>16,28</b>	1
<b>194154</b>	9x12	14	44x22x12,2	<b>17,05</b>	1
<b>194157</b>	9x12	17	48x28x13,2	<b>17,05</b>	1
<b>194159</b>	9x12	19	50x32x13,2	<b>17,05</b>	1
<b>194163</b>	14x18	13	60x30x12	<b>20,37</b>	1
<b>194167</b>	14x18	17	64x31x12,5	<b>20,37</b>	1
<b>194169</b>	14x18	19	66x31x12,5	<b>20,37</b>	1
<b>194172</b>	14x18	22	69x36x15	<b>21,68</b>	1
<b>194174</b>	14x18	24	69x38x15	<b>21,68</b>	1
<b>194175</b>	14x18	27	78x42x17,5	<b>28,70</b>	1
<b>194176</b>	14x18	30	78x45x17,5	<b>28,70</b>	1
<b>194177</b>	14x18	32	80x48x17,5	<b>28,70</b>	1
<b>194178</b>	14x18	36	83x54x19	<b>30,95</b>	1
<b>194179</b>	14x18	41	85x60x19	<b>33,28</b>	1

**Nuevo**

**Juego mango dinamométrico y cabezas**



Medida caja: 620x150x65 mm

**Precisión del par ± 3%**  
**Bocas 14x18 mm**

**COMPOSICION**

1 mango dinamométrico 194115  
1 cabeza intercambiable de carraca 194184  
9 cabezas intercambiables abiertas 13, 14, 15, 17, 19, 22, 24, 27, 30 mm

Code	Nº Piezas	P.V.P. unid. €	
<b>192891</b>	11	<b>390,00</b>	1

**Destornillador dinamométrico**

**DIN**  
**6789**

**Precisión del par ± 5%**



Instrucciones de uso

**HEX 1/4" HEMBRA**



192885

- Ajuste automático del par mediante tornillo
- Escala marcada en láser
- Mango ergonómico de goma antideslizante
- Certificado de calibración individual

**Destornillador dinamométrico gran par**

**DIN**  
**6789**

**Precisión del par ± 5%**



Instrucciones de uso

**HEX 1/4" HEMBRA**



192890

Code	Hex	Capacidad cNm	Nm	Precisión cNm	Nm	P.V.P. unid. €	
<b>192885</b>	1/4	10-120	0,1-1,20	1	0,01	<b>158,43</b>	1
<b>192890</b>	1/4	100-600	1-6	10	0,1	<b>167,08</b>	1

Se suministra en estuche de plástico

**Goniómetro**



- Escala de 360° dividida en marcas de 2°
- Escala con protector plástico para prevenir la suciedad
- Tornillo ajustable que mantiene la escala angular fija

Code	Hembra	Macho	P.V.P. unid. €	
<b>192897</b>	1/2"	1/2"	<b>28,22</b>	1

Se suministra en blister

**Multiplicador de pares**



**Factor multiplicador 5:1**



Instrucciones de uso



Se incluye barra y pie de reacción

Code	Par máx. entrada Nm	Par máx. salida Nm	Entrada	Salida	P.V.P. unid. €	
<b>192892</b>	300	1500	1/2"	3/4"	<b>677,00</b>	1
<b>192893</b>	540	2700	3/4"	1"	<b>714,06</b>	1



## 05 Llaves macho



Llave macho con recubrimiento 109



Llave macho Allen 110



Llave macho de bola 112



Llave macho Torx 113



Mango en T 115



Mango en T aislado 116



Mango en T con vaso 116



Juego de mangos en T 117

**Juego de llaves Allen bola-diamante, soporte de goma**

ACERO CR-V S2



SERIE EXTRALARGA

Recubrimiento plástico rugoso antideslizante

Extremos imantados



Código de colores



Soporte de goma de una sola pieza



PERFIL DE DIAMANTE



Mayor superficie de contacto con la pieza gracias al perfil especial en forma de diamante



COMPOSICION 1'5, 2, 2'5, 3, 4, 5, 6, 8, 10 mm

Code	Nº Piezas	P.V.P. unid. €	
<b>193145</b>	9	<b>21,37</b>	6

Se suministra en blister

**Llave Allen bola-diamante con recubrimiento**

ACERO CR-V S2



SERIE EXTRALARGA



Código de colores



Code	mm	L mm	P.V.P. unid. €	
<b>193171</b>	1,5	92	<b>1,07</b>	10
<b>193172</b>	2	100	<b>1,30</b>	10
<b>193182</b>	2,5	115	<b>1,39</b>	10
<b>193173</b>	3	130	<b>1,44</b>	10
<b>193174</b>	4	145	<b>1,72</b>	10
<b>193175</b>	5	165	<b>2,05</b>	10
<b>193176</b>	6	186	<b>3,15</b>	10
<b>193178</b>	8	208	<b>4,48</b>	10
<b>193181</b>	10	234	<b>6,73</b>	10

Se suministra en blister

**Juego de Llaves Allen, soporte de goma**

ACERO CR-V S2



SERIE EXTRALARGA



Código de colores

Mismas características que 193145



COMPOSICION 1'5, 2, 2'5, 3, 4, 5, 6, 8, 10 mm

Code	Nº Piezas	P.V.P. unid. €	
<b>193144</b>	9	<b>17,43</b>	6

Se suministra en blister

## Juego de Llaves Torx inviolables, soporte de goma

ACERO  
CR-V  
S2

SERIE EXTRALARGA



Código de colores

Mismas características que 193145



### COMPOSICION

T10, T15, T20, T25, T27, T30, T40, T45, T50

Code	Nº Piezas	P.V.P. unid. €	
<b>193148</b>	9	<b>31,52</b>	6

Se suministra en blister

## Llave Allen acodada

DIN  
2936

ACERO  
CR-V



SERIE NORMAL

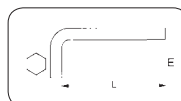

• Terminación niquelado



Code		L mm	E mm	P.V.P. unid. €	
<b>190450</b>	1/16	47	12	<b>0,45</b>	10
<b>190451</b>	5/64	50	16	<b>0,47</b>	10
<b>190452</b>	3/32	56	18	<b>0,52</b>	10
<b>190453</b>	1/8	63	20	<b>0,60</b>	10
<b>190454</b>	5/32	70	25	<b>0,68</b>	10
<b>190455</b>	3/16	80	28	<b>0,82</b>	10
<b>190456</b>	1/4	90	32	<b>0,96</b>	10
<b>190457</b>	5/16	100	36	<b>1,29</b>	10
<b>190458</b>	3/8	115	40	<b>1,50</b>	10

Code		L mm	E mm	P.V.P. unid. €	
<b>193015</b>	1,5	47	12	<b>0,45</b>	10
<b>193002</b>	2	50	16	<b>0,47</b>	10
<b>193025</b>	2,5	56	18	<b>0,52</b>	10
<b>193003</b>	3	63	20	<b>0,60</b>	10
<b>193004</b>	4	70	25	<b>0,68</b>	10
<b>193005</b>	5	80	28	<b>0,82</b>	10
<b>193006</b>	6	90	32	<b>0,96</b>	10
<b>193007</b>	7	95	34	<b>1,29</b>	10
<b>193008</b>	8	100	36	<b>1,50</b>	10
<b>193009</b>	9	105	38	<b>1,97</b>	10
<b>193010</b>	10	112	40	<b>2,02</b>	10
<b>193012</b>	12	125	45	<b>3,04</b>	5
<b>193014</b>	14	140	56	<b>4,25</b>	5
<b>193017</b>	17	160	63	<b>6,88</b>	5
<b>193019</b>	19	180	70	<b>10,32</b>	5
<b>193022</b>	22	200	80	<b>14,19</b>	5

## Juego llaves Allen, soporte de plástico

SERIE NORMAL



- Terminación niquelado
- Soporte de plástico con bisagra de apertura



### COMPOSICION

**193070** 1'5, 2, 2'5, 3, 4, 5, 6, 8, 10 mm

**193071** 1/16', 5/64', 3/32', 1/8', 5/32', 3/16', 1/4', 5/16', 3/8'

Code	Nº Piezas	P.V.P. unid. €	
<b>193070</b>	9	<b>8,18</b>	6
<b>193071</b>	9	<b>8,18</b>	1





**Juego de Llaves Allen en anilla**



**COMPOSICION**

**193055** 2, 2,5, 3, 4, 5, 6, 8 mm

**193056** 1,5, 2, 2,5, 3, 4, 5, 6, 8, 10 mm

Code	Nº Piezas	P.V.P. unid. €	
<b>193055</b>	7	<b>6,27</b>	10
<b>193056</b>	9	<b>7,94</b>	10

Se suministra en bolsa

**Juego de Llaves Allen en navaja**



• Sistema de expulsión de llaves mediante palanca



**COMPOSICION** 1,5, 2, 2,5, 3, 4, 5, 6, 8 mm

Code	Nº Piezas	P.V.P. unid. €	
<b>193082</b>	8	<b>9,50</b>	12

Se suministra en colgador

**Llave Allen acodada**

**DIN**  
2936

**SERIE EXTRALARGA**

**ACERO**  
CR-V



• Terminación niquelado

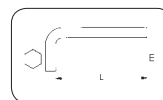

Code	mm	L mm	E mm	P.V.P. unid. €	
<b>193902</b>	2	100	14	<b>0,62</b>	10
<b>193925</b>	2,5	112	18	<b>0,68</b>	10
<b>193903</b>	3	126	20	<b>0,86</b>	10
<b>193904</b>	4	142	25	<b>0,96</b>	10
<b>193905</b>	5	160	28	<b>1,40</b>	10
<b>193906</b>	6	180	32	<b>1,70</b>	10
<b>193907</b>	7	190	34	<b>2,09</b>	10
<b>193908</b>	8	200	36	<b>2,50</b>	10
<b>193910</b>	10	224	40	<b>3,80</b>	10
<b>193912</b>	12	250	45	<b>5,50</b>	5
<b>193914</b>	14	280	55	<b>8,00</b>	5

**Juego de Llaves Allen, soporte plástico**

**SERIE EXTRALARGA**



**COMPOSICION** 1,5, 2, 2,5, 3, 4, 5, 6, 8, 10 mm

Code	Nº Piezas	P.V.P. unid. €	
<b>193970</b>	9	<b>11,59</b>	6

Se suministra en blister

## Llave Allen de bola acodada

DIN  
2936

SERIE EXTRALARGA

ACERO  
CR-V

Terminación niquelado

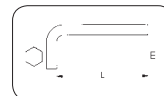

Code	mm	L mm	E mm	P.V.P. unid. €	
190460	1/16	85	12	1,10	10
190461	5/64	100	14	1,15	10
190462	3/32	112	18	1,21	10
190463	1/8	126	20	1,26	10
190464	5/32	142	25	1,50	10
190465	3/16	160	28	1,78	10
190466	1/4	180	32	2,74	10
190467	5/16	200	36	3,80	10
190468	3/8	224	40	6,64	10

Code	mm	L mm	E mm	P.V.P. unid. €	
193102	2	100	14	1,15	10
193125	2,5	112	18	1,21	10
193103	3	126	20	1,26	10
193104	4	142	25	1,50	10
193105	5	160	28	1,78	10
193106	6	180	32	2,74	10
193107	7	190	34	3,00	10
193108	8	200	36	3,90	10
193110	10	224	40	6,64	10
193112	12	250	45	7,14	5
193114	14	280	55	11,51	5

## Juego de Llaves Allen de bola, soporte plástico

SERIE EXTRALARGA

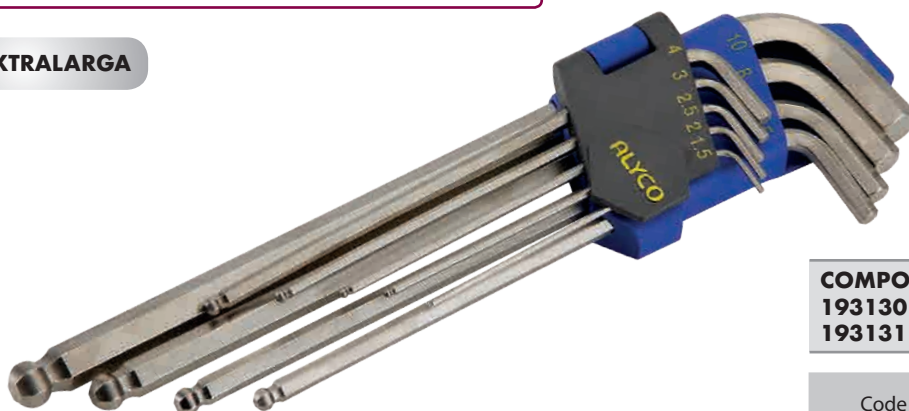

### COMPOSICION

193130 1'5, 2, 2'5, 3, 4, 5, 6, 8, 10 mm

193131 1/16", 5/64", 3/32", 1/8", 5/32", 3/16", 1/4", 5/16", 3/8"

Code	Nº Piezas	P.V.P. unid. €	
193130	9	13,00	6
193131	9	13,30	1



Se suministra en blister

## Juego de Llaves Allen de bola, soporte plástico



### COMPOSICION

1'5, 2, 2'5, 3, 4, 5, 6, 8, 10 mm

Code	Nº Piezas	P.V.P. unid. €	
193140	9	9,07	6

Se suministra en blister

**Llave Torx acodada**

ACERO  
CR-V



• Terminación niquelado

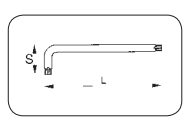

Code	mm	L mm	S mm	P.V.P. unid. €	
<b>193206</b>	T6	66	16	<b>3,23</b>	10
<b>193207</b>	T7	71	16	<b>3,23</b>	10
<b>193208</b>	T8	76	16	<b>3,23</b>	10
<b>193209</b>	T9	80	16	<b>3,27</b>	10
<b>193210</b>	T10	86	17	<b>2,69</b>	10
<b>193215</b>	T15	90	18	<b>2,75</b>	10
<b>193220</b>	T20	95	19	<b>2,79</b>	10
<b>193225</b>	T25	100	20	<b>2,82</b>	10
<b>193227</b>	T27	105	21	<b>2,84</b>	10
<b>193230</b>	T30	114	24	<b>2,88</b>	10
<b>193240</b>	T40	124	26	<b>3,08</b>	5
<b>193245</b>	T45	137	29	<b>3,21</b>	5
<b>193250</b>	T50	152	32	<b>3,50</b>	5
<b>193255</b>	T55	171	35	<b>4,75</b>	5
<b>193260</b>	T60	190	38	<b>5,81</b>	5

**Llave Torx acodada inviolable**

ACERO  
CR-V



• Terminación niquelado

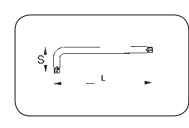

Code	mm	L mm	S mm	P.V.P. unid. €	
<b>194006</b>	T6	66	16	<b>4,20</b>	10
<b>194007</b>	T7	71	16	<b>4,20</b>	10
<b>194008</b>	T8	76	16	<b>4,20</b>	10
<b>194009</b>	T9	80	16	<b>4,25</b>	10
<b>194010</b>	T10	86	17	<b>3,48</b>	10
<b>194015</b>	T15	90	18	<b>3,56</b>	10
<b>194020</b>	T20	95	19	<b>3,64</b>	10
<b>194025</b>	T25	100	20	<b>3,66</b>	10
<b>194027</b>	T27	105	21	<b>3,69</b>	10
<b>194030</b>	T30	114	24	<b>3,73</b>	10
<b>194040</b>	T40	124	26	<b>4,00</b>	5
<b>194045</b>	T45	137	29	<b>4,18</b>	5
<b>194050</b>	T50	152	32	<b>4,57</b>	5
<b>194055</b>	T55	171	35	<b>6,17</b>	5
<b>194060</b>	T60	190	38	<b>7,55</b>	5

**Juego de Llaves Torx, soporte plástico**



COMPOSICION			
T10, T15, T20, T25, T27, T30, T40, T45, T50			
Code	Nº Piezas	P.V.P. unid. €	
<b>193270</b>	9	<b>10,00</b>	6

Se suministra en blister

**Juego de Llaves Torx inviolables, soporte plástico**



COMPOSICION			
T10, T15, T20, T25, T27, T30, T40, T45, T50			
Code	Nº Piezas	P.V.P. unid. €	
<b>193290</b>	9	<b>12,00</b>	6

Se suministra en blister

## Juego de Llaves Torx inviolables, soporte plástico

SERIE EXTRALARGA



### COMPOSICION

T10, T15, T20, T25, T27, T30, T40, T45, T50

Code	Nº Piezas	P.V.P. unid. €	
<b>193292</b>	9	<b>17,00</b>	6

Se suministra en blister

## Juego de Llaves Torx, soporte plástico



### COMPOSICION

T10, T15, T20, T25, T27, T30, T40

Code	Nº Piezas	P.V.P. unid. €	
<b>193060</b>	7	<b>9,33</b>	10

Se suministra en bolsa

## Juego de Llaves Torx inviolables, soporte plástico



### COMPOSICION

T10, T15, T20, T25, T27, T30, T40

Code	Nº Piezas	P.V.P. unid. €	
<b>193061</b>	7	<b>12,11</b>	10

Se suministra en bolsa

## Minijuego de Llaves Torx en navaja



### COMPOSICION

T6, T7, T8, T9, T10, T15, T20, T25

Code	Nº Piezas	P.V.P. unid. €	
<b>193281</b>	8	<b>10,00</b>	6

Se suministra en colgador

## Juego de Llaves Torx inviolables en navaja



### COMPOSICION

T9, T10, T15, T20, T25, T27, T30, T40

Code	Nº Piezas	P.V.P. unid. €	
<b>193283</b>	8	<b>14,00</b>	6

Se suministra en colgador

**Mango en T hexagonal bola diamante**

ACERO  
CR-V

PERFIL DE DIAMANTE



- Mango ergonómico bimaterial para grandes pares de apriete
- Con agujero para colgar
- Terminación satinado mate

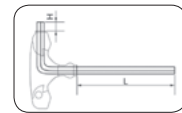

Code	mm	H x L mm	P.V.P. unid. €	
<b>195261</b>	1,5	12x100	<b>3,29</b>	6
<b>195262</b>	2	12x100	<b>3,29</b>	6
<b>195271</b>	2,5	12x100	<b>3,35</b>	6
<b>195263</b>	3	15x100	<b>3,39</b>	6
<b>195264</b>	4	15x100	<b>4,06</b>	6
<b>195265</b>	5	15x150	<b>4,40</b>	6
<b>195266</b>	6	15x150	<b>4,69</b>	6
<b>195268</b>	8	20x200	<b>6,57</b>	6
<b>195270</b>	10	20x200	<b>7,59</b>	6

**Mango en T Torx inviolable**

ACERO  
CR-V

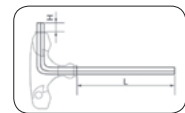

Code	mm	H x L mm	P.V.P. unid. €	
<b>195309</b>	T9	15x100	<b>4,46</b>	6
<b>195310</b>	T10	15x100	<b>4,46</b>	6
<b>195315</b>	T15	15x100	<b>4,57</b>	6
<b>195320</b>	T20	15x100	<b>4,61</b>	6
<b>195325</b>	T25	15x100	<b>5,47</b>	6
<b>195327</b>	T27	15x150	<b>5,62</b>	6
<b>195330</b>	T30	15x150	<b>5,95</b>	6
<b>195340</b>	T40	20x200	<b>6,35</b>	6
<b>195350</b>	T50	20x200	<b>10,25</b>	6

**Juego mangos en T hexagonal bola diamante**



**COMPOSICION**  
2, 2,5, 3, 4, 5, 6, 8, 10 mm

Code	Nº Piezas	P.V.P. unid. €	
<b>195274</b>	8	<b>36,00</b>	1

## Mango en T hexagonal aislado

ACERO  
CR-V

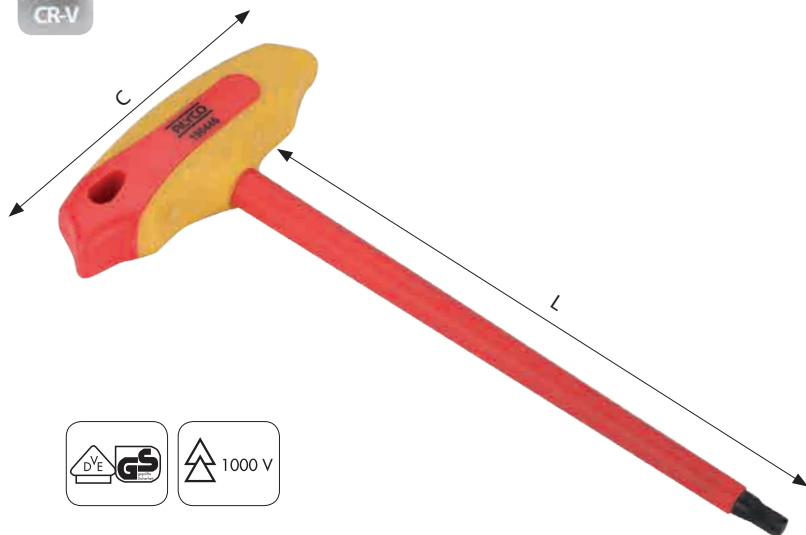

### NORMA EN 60900

Herramientas aisladas utilizadas para trabajos en tensiones de hasta 1000 V en Corriente Alterna ó 1500 V en Corriente Continua



Code	mm	L x C mm	P.V.P. unid. €	
190442	2,5	100x80	8,06	6
190443	3	100x80	8,55	6
190444	4	125x100	10,77	6
190445	5	150x100	11,24	6
190446	6	175x120	13,16	6
190448	8	200x120	15,92	6

## Mango en T con vaso hexagonal

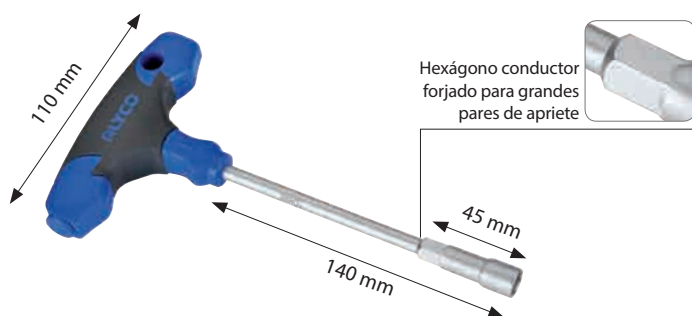

Code	mm	P.V.P. unid. €	
195205	5	7,12	6
195255	5,5	7,12	6
195206	6	7,12	6
195207	7	7,12	6
195208	8	7,37	6
195209	9	7,37	6
195210	10	8,22	6
195211	11	8,22	6
195212	12	9,09	6
195213	13	9,09	6
195214	14	9,71	6

## Mango en T con vaso hexagonal largo

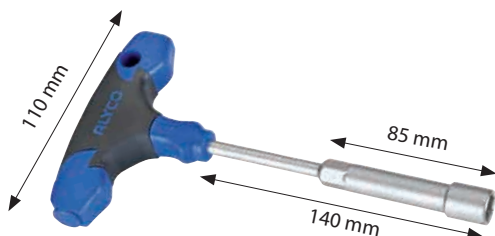

Code	mm	P.V.P. unid. €	
195227	7	8,19	6
195228	8	8,47	6
195230	10	9,47	6
195232	12	10,46	6
195233	13	10,46	6

## Mango en T con adaptador

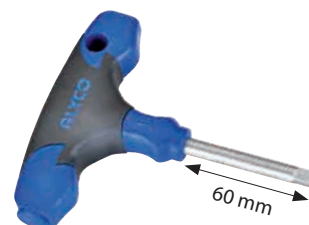
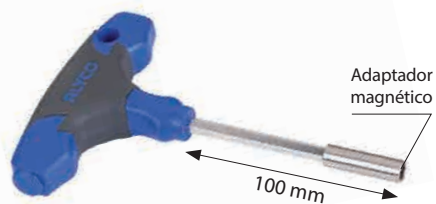

Code	P.V.P. unid. €	
195245	7,68	6



Code	P.V.P. unid. €	
195250	8,63	6



Code	P.V.P. unid. €	
195240	6,26	12

**Juego de mangos en T intercambiables**

ACERO  
CR-V-MO



- Varillas de 125 mm de longitud con doble punta
- Mango ergonómico bicomponente

**COMPOSICION**

- 1 mango en T intercambiable
- 10 Varillas con doble punta:  $\ominus$  3'0 /  $\ominus$  4'0 mm  
 $\ominus$  5'5 /  $\ominus$  6'5 mm  $\bullet$  3'0 /  $\bullet$  4'0 mm  $\bullet$  5,0 /  $\bullet$  6,0 mm  
 $\oplus$  PH1 /  $\oplus$  PH2  $\oplus$  PZ1 /  $\oplus$  PZ2  $\oplus$  PH3 /  $\oplus$  PZ3  
 $\otimes$  T10 /  $\otimes$  T15  $\otimes$  T20 /  $\otimes$  T25  $\otimes$  T30 /  $\otimes$  T40

Code	Nº Piezas	P.V.P. unid. €	
<b>195284</b>	11	<b>21,95</b>	1

**Juego de mangos en T en bolsa de nylon**



**COMPOSICION**

- 8 Mangos hexagonales en T 1,5 - 2 - 2,5 - 3 - 4 - 5 - 6 - 8 mm
- 1 Adaptador magnético con mango en T
- 10 Puntas  $\ominus$  4, 5, 6 mm  $\oplus$  PH1, PH2  $\oplus$  PZ1, PZ2  $\otimes$  T10, T15, T20
- 1 Adaptador vasos de 1/4"

Code	Nº Piezas	P.V.P. unid. €	
<b>195282</b>	20	<b>54,26</b>	2

**Incluye 20 bocas diferentes**

8	3	2	2	3	1	1

**Juego 13 en 1 de mango en T con carraca**

ACERO  
CR-V



Mango en T con sistema de carraca de 3 posiciones



Hexágono para accionar con llave

Varilla de 185 mm de longitud

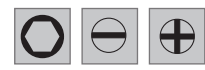

**COMPOSICION**

- 1 mango en T con carraca
- 7 Vasos de 1/4" largos: 6, 8, 10, 11, 12, 13, 14 mm
- 3 Varillas con doble punta:  $\oplus$  PH1/PH2/PH3  $\ominus$  4'5/5'5/6'5

Code	Nº Piezas	P.V.P. unid. €	
<b>193470</b>	11	<b>54,34</b>	1



## 06 Destornilladores y puntas



Punta de atornillar 119



Vaso y adaptador magnético 122



Juego de puntas 123



Destornillador varilla pasante 125



Destornillador 126



Juego de destornilladores 128



Adaptador magnético 130



Destornillador de precisión 132



Destornillador aislado 134



Destornillador precisión aislado 136



Polímetro 137



Tester 137



## CARACTERÍSTICAS DE LAS PUNTAS

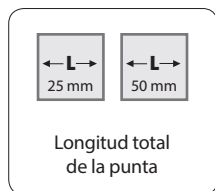

Todas las puntas en dispensadores de plástico

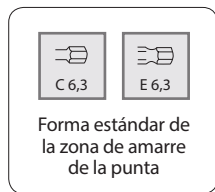

### Punta de 1/4" de 25 mm

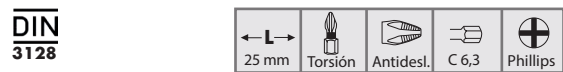

Code	+	P.V.P. unid. €	
<b>193536</b>	PH1	<b>8,10</b>	1
<b>193537</b>	PH2	<b>8,10</b>	1
<b>193538</b>	PH3	<b>8,10</b>	1

Unidad de venta envase de 10 unidades



Code	+	P.V.P. unid. €	
<b>193556</b>	PZ1	<b>8,10</b>	1
<b>193557</b>	PZ2	<b>8,10</b>	1
<b>193558</b>	PZ3	<b>8,10</b>	1

Unidad de venta envase de 10 unidades

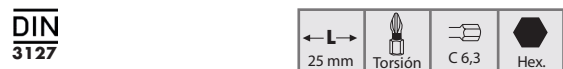

\* Puntas tipo torsión

LAS PUNTAS SOLO SE VENDEN EN EMBALAJE COMPLETO



Code	+	P.V.P. unid. €	
<b>193546</b>	PH1	<b>21,00</b>	1
<b>193547</b>	PH2	<b>21,00</b>	1
<b>193548</b>	PH3	<b>21,00</b>	1

Unidad de venta envase de 10 unidades



Code	+	P.V.P. unid. €	
<b>193566</b>	PZ1	<b>21,00</b>	1
<b>193567</b>	PZ2	<b>21,00</b>	1
<b>193568</b>	PZ3	<b>21,00</b>	1

Unidad de venta envase de 10 unidades

Code	Hex.	P.V.P. unid. €	
<b>193570</b>	1,5*	<b>9,20</b>	1
<b>193572</b>	2*	<b>9,20</b>	1
<b>193571</b>	2,5*	<b>9,20</b>	1
<b>193573</b>	3*	<b>9,20</b>	1
<b>193574</b>	4*	<b>9,20</b>	1
<b>193575</b>	5*	<b>9,20</b>	1
<b>193576</b>	6	<b>9,20</b>	1
<b>193578</b>	8	<b>11,80</b>	1
<b>193580</b>	10	<b>13,40</b>	1

Unidad de venta envase de 10 unidades

## Punta de 1/4" de 25 mm



\* Puntas tipo torsión

Code	★	P.V.P. unid. €	
193581	T10*	9,40	1
193582	T15*	9,40	1
193583	T20*	9,40	1
193584	T25*	9,40	1
193585	T27*	9,40	1
193586	T30*	9,40	1
193587	T40	5,00	1**
193588	T45	5,95	1**
193589	T50	6,20	1**
193603	T55	6,35	1**

Unidad de venta envase de 10 unidades

\*\* Envase de 5 unidades

DIN 3127



## Punta de 1/4" de 50 mm

DIN 3128



Code	⊕	P.V.P. unid. €	
193636	PH1	19,80	1
193637	PH2	19,80	1
193638	PH3	19,80	1

Unidad de venta envase de 10 unidades

DIN 3128



Code	⊕	P.V.P. unid. €	
193656	PZ1	19,80	1
193657	PZ2	19,80	1
193658	PZ3	19,80	1

Unidad de venta envase de 10 unidades



Code	★	P.V.P. unid. €	
193590	T10	10,50	1
193591	T15	10,50	1
193592	T20	10,50	1
193593	T25	10,50	1
193594	T27	10,50	1
193595	T30	10,50	1
193596	T40	5,25	1**
193597	T45	5,80	1**
193598	T50	6,15	1**
193599	T55	6,35	1**

Unidad de venta envase de 10 unidades

\*\* Envase de 5 unidades

Code	mm	P.V.P. unid. €	
193503	0,6 x 4,5	10,00	1
193506	0,8 x 5,5	10,00	1
193511	1 x 5,5	10,00	1
193516	1,2 x 6,5	10,00	1
193521	1,6 x 8	10,00	1

Unidad de venta envase de 10 unidades

DIN 3128



Code	⊕	P.V.P. unid. €	
193646	PH1	31,20	1
193647	PH2	31,20	1
193648	PH3	31,20	1

Unidad de venta envase de 10 unidades

DIN 3128



Code	⊕	P.V.P. unid. €	
193666	PZ1	31,20	1
193667	PZ2	31,20	1
193668	PZ3	31,20	1

Unidad de venta envase de 10 unidades

## Punta de 1/4" de 50 mm

DIN  
3127



Code	mm	P.V.P. unid. €	
193601	0,6 x 4,5	25,10	1
193606	0,8 x 5,5	25,10	1
193611	1 x 5,5	25,10	1
193616	1,2 x 6,5	25,10	1
193621	1,6 x 8	25,10	1

Unidad de venta envase de 10 unidades

## Punta de 1/4" de 100 mm



Code		P.V.P. unid. €	
193964	PH1	19,65	1
193965	PH2	23,58	1

193964 Unidad de venta envase de 5 unidades  
193965 Unidad de venta envase de 6 unidades

## Punta de 1/4" de 150 mm

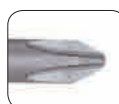

Code		P.V.P. unid. €	
193967	PH1	25,15	1
193968	PH2	25,15	1

Unidad de venta envase de 5 unidades

## Punta de 5/16" de 30 mm



PLANA



PHILLIPS



POZIDRIVE



HEXAGONAL



TORX INV.



XZN

### PUNTA PLANA

Code	mm	P.V.P. unid. €	
193935	5,5	8,15	1
193936	6,5	8,15	1
193938	8	8,15	1
193940	10	10,45	1
193942	12	14,65	1

Unidad de venta envase de 5 unidades

### PHILLIPS

Code		P.V.P. unid. €	
193961	PH1	8,15	1
193962	PH2	8,15	1
193963	PH3	8,15	1

Unidad de venta envase de 5 unidades

### POZIDRIVE

Code		P.V.P. unid. €	
193971	PZ1	8,15	1
193972	PZ2	8,15	1
193973	PZ3	8,15	1

Unidad de venta envase de 5 unidades

### HEXAGONAL

Code	mm	P.V.P. unid. €	
193944	4	8,15	1
193945	5	8,15	1
193946	6	8,15	1
193948	8	8,15	1
193950	10	10,45	1
193952	12	14,65	1
193954	14	21,40	1

Unidad de venta envase de 5 unidades

### TORX INVOLABLE

Code		P.V.P. unid. €	
193990	T20	10,45	1
193991	T25	10,45	1
193992	T27	10,45	1
193993	T30	10,45	1
193994	T40	10,45	1
193995	T45	10,45	1
193996	T50	10,45	1

Unidad de venta envase de 5 unidades

### XZN

Code		P.V.P. unid. €	
193980	M4	13,10	1
193981	M5	13,10	1
193982	M6	13,10	1
193983	M8	13,10	1
193984	M10	16,65	1
193985	M12	24,00	1

Unidad de venta envase de 5 unidades

## Puntas de 3/8" de 30 mm



L: 30 mm

Code	★	P.V.P. unid. €	
186123	T20	20,90	1
186125	T25	20,90	1
186130	T30	20,90	1
186140	T40	20,90	1
186145	T45	20,90	1
186150	T50	20,90	1
186155	T55	20,90	1
186160	T60	24,50	1

Unidad de venta envase de 10 unidades



L: 30 mm

Code	mm	P.V.P. unid. €	
186104	4	16,30	1
186105	5	16,30	1
186106	6	16,30	1
186107	7	16,30	1
186108	8	16,30	1
186110	10	20,90	1
186112	12	24,50	1

Unidad de venta envase de 10 unidades



L: 30 mm

Code	mm	P.V.P. unid. €	
186165	M5	26,20	1
186166	M6	26,20	1
186168	M8	26,20	1
186170	M10	33,30	1
186172	M12	48,50	1

Unidad de venta envase de 10 unidades

## Puntas de 3/8" de 75 mm



L: 75 mm

Code	★	P.V.P. unid. €	
186124	T20	28,50	1
186126	T25	28,50	1
186131	T30	28,50	1
186141	T40	28,50	1
186146	T45	28,50	1
186151	T50	28,50	1
186156	T55	28,50	1
186161	T60	33,10	1

Unidad de venta envase de 10 unidades



L: 75 mm

Code	mm	P.V.P. unid. €	
186114	4	28,50	1
186115	5	28,50	1
186116	6	28,50	1
186117	7	28,50	1
186118	8	28,50	1
186120	10	28,50	1
186122	12	33,10	1

Unidad de venta envase de 10 unidades



L: 75 mm

Code	mm	P.V.P. unid. €	
186175	M5	28,50	1
186176	M6	28,50	1
186178	M8	28,50	1
186180	M10	28,50	1
186182	M12	33,10	1

Unidad de venta envase de 10 unidades

## Vaso magnético. Acoplamiento rápido 1/4"

ACERO CR-V



L: 63 mm



Con imán en la parte interior para una mejor fijación del vaso

## Juego de vasos magnéticos 1/4"



LAS PUNTAS SOLO SE VENDEN EN EMBALAJE COMPLETO

Code	mm	P.V.P. unid. €	
194805	5,5	3,12	6
194806	6	3,12	6
194807	7	3,12	6
194808	8	3,12	6
194809	9	3,12	6
194810	10	3,44	6
194811	11	3,44	6
194812	12	3,44	6
194813	13	3,65	6

Se suministra en estuche con colgador

### COMPOSICION

5', 6, 7, 8, 9, 10, 11, 12, 13 mm

Code	Nº Piezas	P.V.P. unid. €	
194815	9	27,00	6

Se suministra en blister

**Adaptador para vasos**



Code		L mm	P.V.P. unid. €	
<b>193751</b>	1/4"	50	<b>4,00</b>	10
<b>193752</b>	3/8"	50	<b>4,80</b>	10
<b>193753</b>	1/2"	60	<b>5,20</b>	6

**Adaptador con acoplamiento rápido 1/4"**



**Adaptador para vasos de 1/4"**



**Juego de puntas 1/4"**

ACERO CR-V



Código de colores

**Adaptador magnético 1/4"**



Code	L mm	P.V.P. unid. €	
<b>193740</b>	50	<b>4,50</b>	6
<b>193742</b>	100	<b>6,00</b>	6
<b>193744</b>	150	<b>8,00</b>	6

Se suministra en estuche con colgador

No imantado

Code	L mm	P.V.P. unid. €	
<b>193750</b>	60	<b>8,00</b>	6

Se suministra en estuche con colgador

**Nuevo**

Code	L mm	P.V.P. unid. €	
<b>193754</b>	30	<b>1,50</b>	10

**Incluye 12 bocas diferentes**

8	9	8	6	11	4
3	3	4	4	4	4

**COMPOSICION**

- 59 Puntas 1/4" 25 mm:
  - PZ1(2), PZ2(2), PZ3(2)
  - PH1(2), PH2(2), PH3(2)
  - T10, T15(2), T20(2), T25(2), T27, T30
  - 4(2), 5(2), 6(2), mm
  - 4(2), 5(2), 6(2), mm
  - 0, 1, 2, 3
  - 6, 8, 10
  - 1, 2, 3
  - 4, 6, 8, 10
  - 4, 5, 6, 7
- 4, 5, 6, 8
- 1, 2, 3, 4
- 9 puntas 1/4" 75 mm
  - PZ1, PZ2
  - PH1, PH2, PH3
  - T20, T25
  - 4, 6 mm
- 1 Adaptador magnético rápido
- 1 Adaptador magnético
- 1 Avellanador

Code	Nº Piezas	P.V.P. unid. €	
<b>193730</b>	71	<b>30,24</b>	3

Se suministra en blister

## Juego de puntas 1/4"

ACERO  
CR-V



Código de colores

Incluye 6 bocas diferentes



### COMPOSICION

- 30 Puntas 1/4"
- PH1, PH2 (2), PH3
- PZ1, PZ2 (2), PZ3
- 3, 4, 5, 6 mm
- 3, 4, 5, 6 mm
- T10, T15, T20, T25, T27, T30, T40
- T10, T15, T20, T25, T27, T30, T40
- 1 Adap. magnético rápido
- 1 Adap. puntas 1/4"

Code	Nº Piezas	P.V.P. unid. €	
<b>193725</b>	32	<b>16,40</b>	6

Se suministra en blister

## Juego de puntas 3/8"

ACERO  
CR-V

**ESPECIAL AUTOMOCION**



Incluye 3 bocas diferentes



### COMPOSICION

- 20 Puntas 3/8" 30 mm:
- Hex 4, 5, 6, 7, 8, 10, 12 mm
- Xzn M5, M6, M8, M10, M12
- Torx T20, T25, T30, T40, T45, T50, T55, T60
- 1 Adap. 3/8" H para puntas 3/8"
- 20 Puntas 3/8" 75 mm:
- Hex 4, 5, 6, 7, 8, 10, 12 mm
- Xzn M5, M6, M8, M10, M12
- Torx T20, T25, T30, T40, T45, T50, T55, T60
- 1 Adap. 1/2" H para puntas 3/8"

Code	Nº Piezas	P.V.P. unid. €	
<b>186100</b>	42	<b>34,00</b>	1

## Juego de destornillador con carraca y puntas



Incluye 5 bocas diferentes



Incluye adaptador magnético de 100 mm para unir al mango atornillador

### COMPOSICION

- 48 Puntas 1/4" 25 mm:
- 3(1), 4(2), 5(2), 6(2), 7(1) mm
- PH0(2), PH1(2), PH2(2), PH3(2)
- PZ0(2), PZ1(2), PZ2(2), PZ3(2)
- T8, T10, T15, T20, T25, T27, T30, T40
- T8, T10, T15, T20, T25, T27, T30, T40
- 1'5, 2'5, 3, 4, 5, 5'5, 6 mm
- 1 Adap. magnético 100 mm
- 1 Adap. magnético rápido 60 mm
- 1 Adap. para vasos 1/4" 50 mm
- 1 Adaptador para puntas de 1/4"
- 32 puntas 1/4" 50 mm
- 3, 4, 5, 6(4), 7 mm
- PH1, PH2(2), PH3
- PZ1, PZ2(2), PZ3
- T10, T15(2), T20(2), T25(2), T27, T30, T40
- 2'5, 3, 4, 5, 5'5, 6 mm
- 1 Avellanador de 1/4"
- 1 Mango atornillador con carraca
- 10 Vasos magnéticos 1/4": 4, 5, 6, 7, 8, 9, 10, 11, 12, 13 mm

Code	Nº Piezas	P.V.P. unid. €	
<b>119150</b>	96	<b>55,93</b>	1

**Destornillador con varilla pasante**

ACERO CR-V S2



Punta negra magnética

Varilla hexagonal. Acero especial S2 (gran resistencia al desgaste)

Mango ergonómico con 4 materiales diferentes



Tope superior con alojamiento hexagonal de 8mm



Varilla pasante con tope superior forjado

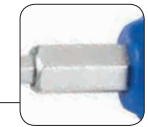

Hexágono conductor. Fabricado en 2 piezas. Mayor par de apriete.

**BOCA PLANA**

Code	Ø mm	mm	mm	P.V.P. unid. €	
<b>119205</b>	5,5	1,0	125	<b>6,44</b>	12
<b>119206</b>	6,5	1,2	150	<b>7,14</b>	12
<b>119208</b>	8,0	1,2	150	<b>8,55</b>	12

Se suministra con colgador

**Boca Phillips**

ACERO CR-V S2



Code	+	mm	P.V.P. unid. €	
<b>119231</b>	PH1	100	<b>5,72</b>	12
<b>119232</b>	PH2	150	<b>6,88</b>	12

Se suministra con colgador

**Boca Pozidrive**

ACERO CR-V S2



Code	+	mm	P.V.P. unid. €	
<b>119241</b>	PZ1	100	<b>6,30</b>	12
<b>119242</b>	PZ2	150	<b>7,56</b>	12

Se suministra con colgador

**Juego de destornilladores pasantes**



**Nuevo**

**COMPOSICION**

**Tope superior • Hex. conductor • Varilla hexagonal**

- 5,5 x 100 mm / 6,5 x 125 mm (Boca plana)
- ⊕ PH1 x 80 mm / PH2 x 100 mm
- ⊕ PZ1 x 80 mm / PZ2 x 100 mm

○ 3 x 75 mm\* / 4 x 80 mm (Boca recta)\*  
\*sin tope superior, hexágono conductor ni varilla hexagonal  
Con varilla cilíndrica

Code	Nº Piezas	P.V.P. unid. €	
<b>119201</b>	8	<b>46,36</b>	1

## Destornillador boca plana

DIN 5265

ACERO CR-V S2



- Terminación cromado satinado mate
- Mango ergonómico de gran volumen
- Tope superior con símbolo del tipo de punta

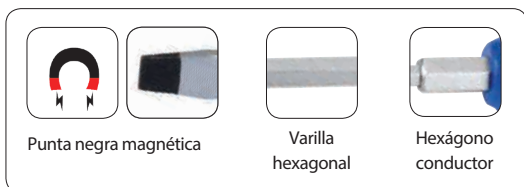

Punta negra magnética

Varilla hexagonal

Hexágono conductor

Code	mm	mm	mm	P.V.P. unid. €	
<b>119004</b>	4,0*	0,8	80	<b>3,43</b>	12
<b>119005</b>	5,5	1,0	125	<b>4,36</b>	12
<b>Nuevo 119007</b>	6,5	1,2	100	<b>5,40</b>	12
<b>119006</b>	6,5	1,2	150	<b>5,80</b>	12
<b>119008</b>	8,0	1,2	150	<b>6,91</b>	12
<b>119010</b>	10,0*	1,6	200	<b>8,42</b>	12

\* Destornillador con varilla cilíndrica y sin hexágono conductor

## Destornillador boca recta

DIN 5265

ACERO CR-V S2



Con varilla cilíndrica y sin hexágono conductor

Code	mm	mm	mm	P.V.P. unid. €	
<b>119022</b>	2,5	0,4	75	<b>2,75</b>	12
<b>119023</b>	3,0	0,5	100	<b>2,81</b>	12
<b>119024</b>	4,0	0,8	100	<b>3,45</b>	12
<b>119025</b>	5,0	0,8	150	<b>4,59</b>	12

## Destornillador boca Phillips

DIN 5262

ACERO CR-V S2



Code		mm	P.V.P. unid. €	
<b>119030</b>	PH0*	75	<b>3,04</b>	12
<b>119031</b>	PH1	100	<b>4,14</b>	12
<b>119029</b>	PH2	100	<b>4,92</b>	12
<b>119032</b>	PH2	150	<b>5,17</b>	12
<b>119033</b>	PH3	150	<b>7,91</b>	12

\* Destornillador con varilla cilíndrica y sin hexágono conductor

## Destornillador boca Pozidrive

DIN 5262

ACERO CR-V S2



Code		mm	P.V.P. unid. €	
<b>119040</b>	PZ0*	75	<b>3,70</b>	12
<b>119041</b>	PZ1	100	<b>4,50</b>	12
<b>119042</b>	PZ2	150	<b>5,59</b>	12
<b>119043</b>	PZ3	150	<b>8,28</b>	12

\* Destornillador con varilla cilíndrica y sin hexágono conductor

## Destornillador boca Torx inviolable

ACERO CR-V S2



Code		mm	P.V.P. unid. €	
<b>119091</b>	T10	80	<b>4,53</b>	12
<b>119092</b>	T15	80	<b>4,66</b>	12
<b>119093</b>	T20	100	<b>4,66</b>	12
<b>119094</b>	T25	100	<b>4,97</b>	12
<b>119095</b>	T27	100	<b>5,05</b>	12
<b>119096</b>	T30	100	<b>5,81</b>	12
<b>119097</b>	T40	125	<b>6,74</b>	12
<b>119098</b>	T45	125	<b>7,73</b>	12



## Destornillador boca recta. Serie corta

DIN  
5265

ACERO  
CR-V  
S2



Code	Ø mm	mm	mm	P.V.P. unid. €	
<b>119012</b>	5,5	1,0	38	<b>4,17</b>	12
<b>119014</b>	6,5	1,2	38	<b>5,46</b>	12

## Destornillador boca Phillips. Serie corta

DIN  
5262

ACERO  
CR-V  
S2



Code	Tip	mm	P.V.P. unid. €	
<b>119035</b>	PH1	38	<b>3,93</b>	12
<b>119036</b>	PH2	38	<b>4,97</b>	12

## Destornillador boca recta. Serie larga

DIN  
5265

ACERO  
CR-V  
S2



Code	Ø mm	mm	mm	P.V.P. unid. €	
<b>119016</b>	4,0	0,8	250	<b>5,14</b>	12
<b>119018</b>	6,0	1,0	300	<b>7,44</b>	12

## Destornillador boca Phillips. Serie larga

DIN  
5262

ACERO  
CR-V  
S2



Code	Tip	mm	P.V.P. unid. €	
<b>119038</b>	PH1	250	<b>5,66</b>	12
<b>119039</b>	PH2	300	<b>7,00</b>	12

## Destornillador con vaso hexagonal

ACERO  
CR-V  
S2



Hexágono conductor para accionar con llave y utilizar en trabajos que requieran gran par de apriete



Code	Ø mm	mm	P.V.P. unid. €	
<b>119074</b>	5	150	<b>5,86</b>	12
<b>119075</b>	5,5	150	<b>5,86</b>	12
<b>119076</b>	6	150	<b>5,86</b>	12
<b>119077</b>	7	150	<b>6,00</b>	12
<b>119078</b>	8	150	<b>6,00</b>	12
<b>119079</b>	9	150	<b>6,72</b>	12
<b>119080</b>	10	150	<b>6,72</b>	12
<b>119081</b>	11	150	<b>7,49</b>	12
<b>119082</b>	12	150	<b>7,49</b>	12
<b>119083</b>	13	150	<b>7,79</b>	12
<b>119084</b>	14	150	<b>7,79</b>	12

## Magnetizador - Desmagnetizador



Para desmagnetizar introducir lentamente a través de la abertura señalizada con (-)



Para magnetizar introducir lentamente a través de la abertura señalizada con (+)



• Magnetiza pequeñas herramientas para extraer fácilmente todo tipo de tornillos y tuercas

Code	Medida mm	P.V.P. unid. €	
<b>121530</b>	52x50x28	<b>1,70</b>	6

Se suministra en blister

## Juego de destornilladores



### COMPOSICION

- ⊖ 3x100 mm\* / 4x100 mm (recta)\*
  - ⊖ 5'5x125mm\*\*/ 6'5x150 mm (plana)\*\*
  - ⊕ PH0x75mm\* / PH1x100 mm\*\*
- \* Con varilla cilíndrica. Sin hexágono  
\*\* Con varilla hexagonal y hexágono

Code	Nº Piezas	P.V.P. unid. €	
<b>119050</b>	6	<b>23,00</b>	1

## Juego de destornilladores



### COMPOSICION

- ⊖ 3x100 mm\* / 4x100 mm (recta)\*
  - ⊖ 5'5x125mm\*\*/ 6'5x150 mm (plana)\*\*
  - ⊕ PH0x75mm\* / PH1x100 mm\*\*
- \* Con varilla cilíndrica. Sin hexágono  
\*\* Con varilla hexagonal y hexágono

Code	Nº Piezas	P.V.P. unid. €	
<b>119049</b>	6	<b>22,80</b>	1

## Juego de destornilladores



### COMPOSICION 119055

- ⊖ 3x100 mm (Boca recta)\*
  - ⊖ 4x80 mm\* / 6'5x150 mm\*\* / 8x150 mm\*\* (Boca plana)
  - ⊕ PH1x100 mm\*\* / PH2x150 mm\*\*
  - ⊕ PZ1x100 mm\*\* / PZ2x150 mm\*\*
- \* Con varilla cilíndrica. Sin hexágono conductor  
\*\* Con varilla hexagonal y hexágono conductor

Code	Nº Piezas	P.V.P. unid. €	
<b>119055</b>	8	<b>38,09</b>	1

## Juego de destornilladores, módulo



Medida caja: 255x185x48 mm



### COMPOSICION

- ⊖ 3x100 mm\* / 4x100 mm (Boca recta)\*
  - ⊖ 5'5x100 mm\*\*/ 6'5x125 mm\*\* / 6'5x38 mm\*
  - ⊕ PH1x100 mm\*\* / PH2x100 mm\*\* / PH2x38 mm\*
  - ⊕ PZ1x100 mm\*\* / PZ2x100 mm\*\*
- \* Con varilla cilíndrica. Sin hexágono conductor  
\*\* Con varilla hexagonal y hexágono conductor

Code	Nº Piezas	P.V.P. unid. €	
<b>119090</b>	10	<b>40,47</b>	1

**Juego destornilladores punta plana**



**Planos**

**COMPOSICION**  
 3x100mm\* (B. recta), 4x80\*, 5,5x125\*\*, 6,5x150\*\*, 8x150\*\*  
 \* Con varilla cilíndrica. Sin hexágono conductor  
 \*\* Con varilla hexagonal y hexágono conductor

Code	Nº Piezas	P.V.P. unid. €	
<b>119057</b>	5	<b>23,60</b>	1

**Juego destornilladores punta Phillips**



**Phillips**

**COMPOSICION**  
 PH0x75\*, PH1x100\*\*, PH2x150\*\*, PH3x150\*\*, PH4x200mm\*\*  
 \* Con varilla cilíndrica. Sin hexágono conductor  
 \*\* Con varilla hexagonal y hexágono conductor

Code	Nº Piezas	P.V.P. unid. €	
<b>119058</b>	5	<b>27,00</b>	1

**Juego destornilladores Torx inviolable**



**Torx Inviolable**

**COMPOSICION**  
 T10x80, T15x80, T20x100, T25x100, T30x100, T40x125

Code	Nº Piezas	P.V.P. unid. €	
<b>119099</b>	6	<b>34,00</b>	6

**Juego destornilladores con vaso**

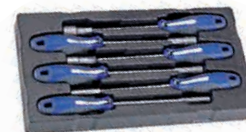

**COMPOSICION**  
 6, 8, 10, 11, 12, 13 x 150 mm

Code	Nº Piezas	P.V.P. unid. €	
<b>119085</b>	6	<b>41,35</b>	1

**Juego de Destornilladores, bolsa nylon**



**Incluye 22 bocas**

5	3	2	4
6	1	1	



**COMPOSICION**  
 3x100\* / 4x100 mm\* (boca recta)  
 5'5x125\*\* / 6'5x150 mm\*\* / 6'5x38 mm\* (boca plana)  
 PH1x100\*\*/ PH2x150 mm\*\* PH2x38 mm\*  
 PZ1x100\*\*/ PZ2x150 mm\*\*  
 1 Adapt. vasos 1/4" 1 Adaptador magnético con mango  
 10 Puntas en soporte de plástico  
 4 3, 4, 5, 6 mm 6 T10, T15, T20, T25, T30, T40  
 \* Con varilla cilíndrica. Sin hexágono conductor  
 \*\* Con varilla hexagonal y hexágono conductor

Code	Nº Piezas	P.V.P. unid. €	
<b>119060</b>	22	<b>52,86</b>	1

## Destornillador con carraca, vasos y puntas



**CARRACA REGULABLE**  
- A derechas  
- A izquierdas  
- Bloqueado



### COMPOSICION

- 1 Mango atornillador con carraca
- 1 Adaptador para vasos de 1/4"
- 1 Adaptador magnético de 100 mm
- 8 Vasos de 1/4": 6, 7, 8, 9, 10, 11, 12, 13 mm
- 10 Puntas de: 4, 5, 6 mm T10, T15, T20 PH1, PH2 PZ1, PZ2

Code	Nº Piezas	P.V.P. unid. €	
<b>119115</b>	21	<b>25,00</b>	1

Se suministra en blister

## Juego adaptador magnético y puntas



### COMPOSICION

- 1 Adaptador magnético para bits de 1/4" (119100)
- 1 Adaptador para vasos de 1/4"
- 10 Puntas: 4, 5, 6 mm T10, T15, T20 PH1, PH2 PZ1, PZ2

Code	Nº Piezas	P.V.P. unid. €	
<b>119110</b>	12	<b>11,00</b>	6

Se suministra en blister

## Adaptador magnético para puntas de 1/4"



Code		mm	P.V.P. unid. €	
<b>119100</b>	1/4"	100	<b>6,50</b>	12

## Adaptador magnético rápido puntas de 1/4"



Code		mm	P.V.P. unid. €	
<b>119107</b>	1/4"	40	<b>7,20</b>	12

**Adaptador para vasos 1/4"**



Code	mm	mm	P.V.P. unid. €	
<b>119105</b>	1/4"	60	<b>6,00</b>	12

**Adaptador magnético flexible puntas 1/4"**



Code	mm	mm	P.V.P. unid. €	
<b>119102</b>	1/4"	190	<b>9,58</b>	12

**Destornillador intercambiable**

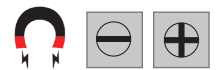

Code	mm	mm	P.V.P. unid. €		
<b>119120</b>	6	PH2	125	<b>5,31</b>	12
<b>119125</b>	6	PH2	175	<b>5,79</b>	12
<b>119130</b>	6	PH2	63	<b>5,00</b>	12

**Juego de 20 destornilladores en 1 intercambiables**

ACERO CR-V-MO



- Varilla de Acero al Cr-V-Mo con punta magnética
- Ranuras para fijación con el mango (doble posición)



**COMPOSICION**

- 1 mango bicomponente
- 10 Varillas con doble punta: 1- 3'0 / 4'0 mm
- 1- 5'5 / 6'5 mm 1- 3'0 / 4'0 mm 1- 5'0 / 6'0 mm
- 1- PH1 / PH2 1- PZ1 / PZ2 1- PH3 / PZ3
- 1- T10 / T15 1- T20 / T25 1- T30 / T40

Code	Nº Piezas	P.V.P. unid. €	
<b>119117</b>	11	<b>26,00</b>	1

**Juego de 20 destornilladores en 1**

ACERO CR-V-MO

20 PUNTAS EN 1



- Ranuras para fijación con el mango
- Puntas negras y magnéticas
- Cierre telescópico
- Mango ergonómico bicomponente

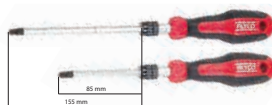

- Doble posicionamiento para cada varilla:**
- Normal con varilla de 85 mm
- Largo con varilla de 155 mm



**COMPOSICION**

- 1 mango bicomponente
- 10 Varillas con doble punta: 1- 4'0 / 5'5 mm
- 1- 4'5 / 6'5 mm 1- 3'0 / 4'0 mm 1- 5'0 / 6'0 mm
- 1- PH1 / PH2 1- PZ1 / PZ2 1- PH3 / PZ3
- 1- T10 / T15 1- T20 / T25 1- T30 / T40

Code	Nº Piezas	P.V.P. unid. €	
<b>193455</b>	11	<b>43,40</b>	1

## Destornillador de precisión. Boca Phillips

ACERO  
CR-V-MO



**Empleo en relojería, electrónica, ordenadores, electrodomésticos, comunicación...**

Code	+	mm	P.V.P. unid. €	
<b>119529</b>	PH00	50	<b>3,07</b>	12
<b>119530</b>	PH0	50	<b>3,07</b>	12
<b>119531</b>	PH1	50	<b>3,07</b>	12

## Destornillador de precisión. Boca Recta

ACERO  
CR-V-MO



Code	—	mm	P.V.P. unid. €	
<b>119501</b>	1,0	50	<b>3,07</b>	12
<b>119515</b>	1,5	50	<b>3,07</b>	12
<b>119502</b>	2,0	50	<b>3,07</b>	12
<b>119525</b>	2,5	50	<b>3,07</b>	12
<b>119503</b>	3,0	50	<b>3,07</b>	12

## Destornillador de precisión. Boca Torx Inviolable

ACERO  
CR-V-MO



Code	⊛	mm	P.V.P. unid. €	
<b>119535</b>	T5	50	<b>3,19</b>	12
<b>119536</b>	T6	50	<b>3,19</b>	12
<b>119537</b>	T7	50	<b>3,19</b>	12
<b>119538</b>	T8	50	<b>3,19</b>	12
<b>119539</b>	T10	50	<b>3,19</b>	12
<b>119540</b>	T15	50	<b>3,19</b>	12

## Juego de destornilladores de precisión



### COMPOSICION

- 1'5x50, 2'0x50, 3'0x50 mm
- ⊛ PH00x50, PH0x50, PH1x50 mm

Code	Nº Piezas	P.V.P. unid. €	
<b>193465</b>	6	<b>18,00</b>	1

## Juego de 30 destornilladores de precisión en 1



Código de colores



Alargadera con 3 hendiduras

### 30 PUNTAS EN 1



#### COMPOSICION

- 1 mango de destornillador de precisión
- 1 adaptador magnético para puntas 110 mm
- Puntas:
  - ⊖ 1.0, 1.5, 2.0, 2.5, 3.0, 3.5, 4.0
  - ⊕ PH000, PH00, PH0, PH1 ⊕ PZ0, PZ1
  - ⬡ 0.7, 0.9, 1.3, 1.5, 2.0, 2.5, 3.0, 4.0
  - ⊛ T4, T5, T6, T7, T8, T9, T10, T15, T20

Code	Nº Piezas	P.V.P. unid. €	
<b>193467</b>	32	<b>22,00</b>	1

## Expositor para destornilladores



#### COMPOSICION

- **Pasantes:**
    - ⊖ 8x1'2x150 (12) (boca recta)
  - **Normal:**
    - ⊖ 5'5x1x125 (12)\*, 6'5x1'2x150 (12)\*, 8x1'2x150 (12)\* (boca plana)
    - ⊖ 3x0'5x100 (12), 4x0'8x100 (12) (boca recta)
    - ⊕ PH1x100 (12)\*, PH2x150 (12)\*
    - ⊕ PZ1x100 (12)\*, PZ2x150 (12)\*
    - ⊛ T10x80 (12), T15x80 (12), T20x100 (12)
  - Portapuntas magnético de 1/4" (12)
  - Destornillador intercambiable ⊕ PH2- ⊖ 6x125 (12) (119120)
- \* Con hexágono conductor y varilla hexagonal

Code	Nº Piezas	P.V.P. unid. €	
<b>119051</b>	180	<b>982,05</b>	1

## Expositor doble para destornilladores



#### COMPOSICION

- **Pasantes:**
    - ⊖ 6'5x1'2x150 (12), 8'0x1'2x150 (12) (Plana)
    - ⊕ PH1x100(12), PH2x150(12)
    - ⊕ PZ1x100(12), PZ2x150(12)
  - **Normal:**
    - ⊖ 4x0'8x80 (12), 5'5x1x125 (12)\*, 6'5x1'2x150 (12)\*, 8x1'2x150 (12)\* (Plana)
    - ⊖ 2'5x0'4x75 (12), 3x0'5x100 (12), 4x0'8x100 (12), 5x0'8x150 (12) (Recta)
    - ⊕ PH0x75 (12), PH1x100 (12)\*, PH2x150 (12)\*, PH3x150 (12)\*
    - ⊕ PZ0x75 (12), PZ1x100 (12)\*, PZ2x150 (12)\*
    - ⊛ T10x80 (12), T15x80 (12), T20x100 (12)
  - **Serie corta:**
    - ⊖ 6'5x1'2x38 (12) (Plana) ⊕ PH2x38 (12)
  - **Serie larga:**
    - ⊖ 6x1x300 (12) (Plana) ⊕ PH2x300 (12)
  - Destornillador intercambiable ⊕ PH2- ⊖ 6x175 (12) (119125)
  - Destornillador intercambiable ⊕ PH2- ⊖ 6x63 (12) (119130)
- \* Con hexágono conductor y varilla hexagonal

Code	Nº Piezas	P.V.P. unid. €	
<b>119052</b>	360	<b>1.946,26</b>	1

## Destornillador boca plana aislado

DIN  
5265

ACERO  
CR-V-MO

Certificado VDE

### NORMA EN 60900

Herramientas aisladas utilizadas para trabajos en tensiones de hasta 1000V en Corriente Alterna ó 1500 V en Corriente Continua

### VARILLA REBAJADA



Mejor acceso en espacios reducidos



Mango ergonómico bimaternal

Punta negra magnética

Marcado indeleble de homologación de la norma EN 60900



Code	mm	mm	mm	P.V.P. unid. €	
<b>Nuevo 119302</b>	2,5*	0,4	80	<b>3,15</b>	12
<b>119303</b>	3,0*	0,5	100	<b>3,35</b>	12
<b>119304</b>	4,0	0,8	100	<b>4,05</b>	12
<b>119305</b>	5,5	1,0	125	<b>5,48</b>	12
<b>119306</b>	6,5	1,2	150	<b>6,91</b>	12
<b>119308</b>	8,0	1,2	175	<b>9,08</b>	12

\* Medida sin varilla rebajada

## Destornillador boca Phillips aislado

DIN  
5262

### VARILLA REBAJADA

ACERO  
CR-V-MO

Certificado VDE



Code		mm	P.V.P. unid. €	
<b>119310</b>	PH0*	75	<b>3,65</b>	12
<b>119311</b>	PH1	100	<b>4,53</b>	12
<b>119312</b>	PH2	100	<b>5,48</b>	12

\* Medida sin varilla rebajada

## Destornillador boca Pozidrive aislado

DIN  
5262

### VARILLA REBAJADA

ACERO  
CR-V-MO

Certificado VDE



Code		mm	P.V.P. unid. €	
<b>119321</b>	PZ1	100	<b>5,04</b>	12
<b>119322</b>	PZ2	100	<b>6,09</b>	12

## Destornillador con vaso hexagonal aislado

ACERO  
CR-V

Certificado VDE



Code	mm	mm	P.V.P. unid. €	
<b>119345</b>	5	125	<b>6,97</b>	10
<b>119344</b>	5,5	125	<b>6,97</b>	10
<b>119346</b>	6	125	<b>6,97</b>	10
<b>119347</b>	7	125	<b>7,12</b>	10
<b>119348</b>	8	125	<b>7,12</b>	10
<b>119349</b>	9	125	<b>7,54</b>	10
<b>119350</b>	10	125	<b>7,54</b>	10
<b>119351</b>	11	125	<b>8,36</b>	10
<b>119352</b>	12	125	<b>8,36</b>	10
<b>119353</b>	13	125	<b>8,60</b>	10



**Nuevo**

**Juego de destornilladores aislados, caja de cartón**



**VARILLA REBAJADA**

**Certificado VDE**



**COMPOSICION**  
 ⌀ 2,5x80\*, 4x100, 5'5x125, 6'5x150 mm  
 ⊕ PH0x75, PH1x100, PH2x100 mm  
 ⌀ Tester 3x140 mm  
 \*Varilla sin rebajar

Code	Nº Piezas	P.V.P. unid. €	
<b>119341</b>	8	<b>31,00</b>	1

**Juego de destornilladores aislados, módulo**



Medida caja: 255x185x48 mm

**VARILLA REBAJADA**

**Certificado VDE**



**COMPOSICION**  
 ⌀ 3x100\*, 4x100, 5'5x100 mm  
 ⊕ PH1x100, PH2x100 mm  
 ⊕ PZ1x100, PZ2x100 mm  
 ⌀ Tester 3x140 mm  
 \*Varilla sin rebajar

Code	Nº Piezas	P.V.P. unid. €	
<b>119335</b>	8	<b>35,77</b>	1

**Juego de destornilladores aislados, caja de cartón**

**VARILLA REBAJADA**



**Juego de destornilladores aislados en blister**

**VARILLA REBAJADA**



**Certificado VDE**



**COMPOSICION**  
 ⌀ 3x100\*, 4x100, 5'5x125, 6'5x150 mm  
 ⊕ PH1x100, PH2x100 mm  
 \*Varilla sin rebajar

**Certificado VDE**



**COMPOSICION**  
 ⌀ 3x100\*, 4x100, 5'5x125, 6'5x150 mm  
 ⊕ PH1x100, PH2x100 mm  
 \*Varilla sin rebajar

Code	Nº Piezas	P.V.P. unid. €	
<b>119330</b>	6	<b>30,35</b>	1

Code	Nº Piezas	P.V.P. unid. €	
<b>119331</b>	6	<b>29,07</b>	1

## Destornillador de precisión boca Phillips aislado

ACERO  
CR-V-MO



### NORMA EN 60900

Herramientas aisladas utilizadas para trabajos en tensiones de hasta 1000V en Corriente Alterna ó 1500 V en Corriente Continua

Certificado VDE



Code	Tip	mm	P.V.P. unid. €	Qty
119365	PH00	50	3,50	12
119366	PH0	50	3,50	12
119367	PH1	50	3,50	12

## Destornillador de precisión boca recta aislado

ACERO  
CR-V-MO



Certificado VDE



Code	Tip	mm	P.V.P. unid. €	Qty
119361	1,5	50	3,50	12
119362	2,0	50	3,50	12
119363	2,5	50	3,50	12
119364	3,0	50	3,50	12

## Destornillador de precisión boca Torx aislado

ACERO  
CR-V-MO



Certificado VDE



Code	Tip	mm	P.V.P. unid. €	Qty
119368	T5	50	3,50	12
119369	T6	50	3,50	12
119370	T7	50	3,50	12
119371	T8	50	3,50	12
119372	T10	50	3,50	12
119373	T15	50	3,50	12

## Juego de destornilladores de precisión aislados



Certificado VDE

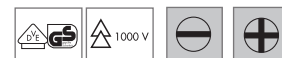

### COMPOSICION

⊖ 1'5x50, 2'0x50, 3'0x50 mm  
⊕ PH00x50, PH0x50, PH1x50 mm

Code	Nº Piezas	P.V.P. unid. €	Qty
119375	6	20,30	1

**Juego de destornilladores intercambiables aislados**



**VARILLA REBAJADA**

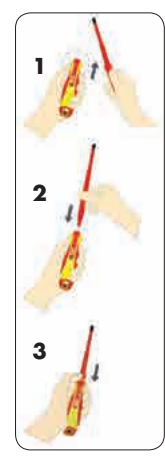

**Certificado VDE**



**COMPOSICION**  
 ⊖ 3x75\*, 4x100, 5'5x125, 6,5x150 mm  
 ⊕ PH0x75\*, PH1x100, PH2x100 mm  
 ⊗ PZ1x100, PZ2x100 mm  
 ⊖ Tester 3x140 mm  
 \*Varilla sin rebajar

Code	Nº Piezas	P.V.P. unid. €	
<b>119332</b>	11	<b>37,20</b>	3

**Polímetro**



**INCLUYE:**  
  
 2 x AA

**FUNCIONES:**  
 - Voltaje  
 - Intensidad  
 - Resistencia  
 - Diodo  
 - Continuidad

• Gran pantalla LCD  
 • Ruleta giratoria para una fácil selección  
 • Diseño ergonómico

Code	P.V.P. unid. €	
<b>119339</b>	<b>25,40</b>	1

Se suministra en caja de cartón

**Tester 8 en 1**



L: 190 mm

**VOLTAJE TESTABLE** 6, 12, 24, 50, 110, 220 y 380 V 6 V

Code	P.V.P. unid. €	
<b>119338</b>	<b>24,00</b>	1

Se suministra en blister

**Tester 3 en 1**



L: 190 mm

**VOLTAJE TESTABLE** 110, 220 y 380 V 150, 380 y 500 V

Code	P.V.P. unid. €	
<b>119336</b>	<b>10,20</b>	1

Se suministra en blister

**Tester**



**VOLTAJE TESTABLE 100-250 V.**



Code	mm	mm	P.V.P. unid. €	
<b>193369</b>	3	140	<b>2,50</b>	24



## 07 Llaves de vaso



Vaso de 1/4"

139



Vaso de 3/8"

144



Vaso de 1/2"

146



Vaso de automoción

152



Vaso aislado

154



Vaso de 3/4"

157



Vaso de 1"

158



Vaso de impacto

159

## Juego de Vasos de 1/4"

ACERO  
CR-V

Carraca  
extensible



Dimensión caja: 365x240x85 mm

### COMPOSICION

1	Carraca extensible (192139)	1	Alargadera flexible 150 mm	1	Adapt. vasos 1/4"
13	Vasos 4 a 14 mm	2	Alargaderas 50, 150 mm	1	Atornillador 150 mm
6	Vasos largos 6, 7, 8, 10, 12, 13 mm	1	Junta universal	4	Llaves allen 1'25, 1'5, 2, 2'5 mm
5	Vasos torx hembra E-4, E-5, E-6, E-7, E-8	1	Adaptador 1/4" M x 3/8" H	1	Adap. puntas 1/4"
21	Vasos con puntas	6	3, 4, 5, 6, 7, 8 mm	3	4, 5'5, 7 mm
		3	PH1, PH2, PH3	3	PZ1, PZ2, PZ3
		6	T10, T15, T20, T25, T30, T40		



Code	Nº Piezas	P.V.P. unid. €	
<b>192187</b>	58	<b>63,20</b>	1

## Juego de Vasos de 1/4" - pulgadas

ACERO  
CR-V

Carraca  
extensible



Dimensión caja: 365x240x85 mm



### COMPOSICION

1	Carraca extensible (192139)	1	Alargadera flexible 150 mm	1	Adap. puntas 1/4"
11	Vasos 5/32", 3/16", 7/32", 1/4", 9/32", 5/16", 11/32", 3/8", 7/16", 1/2", 9/16"	2	Alargaderas 50, 150 mm	1	Adapt. vasos 1/4"
6	Vasos largos 1/4", 9/32", 5/16", 3/8", 7/16", 1/2"	1	Junta universal	1	Atornillador 150 mm
5	Vasos torx hembra E-4, E-5, E-6, E-7, E-8	1	Adaptador 3/8" H x 1/4" M	4	Llaves allen 1'25, 1'5, 2, 2'5 mm
21	Vasos con puntas	6	3, 4, 5, 6, 7, 8 mm	3	4, 5'5, 7 mm
		3	PH1, PH2, PH3	3	PZ1, PZ2, PZ3
		6	T10, T15, T20, T25, T30, T40		



Code	Nº Piezas	P.V.P. unid. €	
<b>190295</b>	56	<b>70,36</b>	1

## Juego de Vasos de 1/4"

ACERO  
CR-V

Carraca  
extensible



Muy compacto



Dimensión caja: 160x110x40 mm



### COMPOSICION

1	Carraca extensible (192139)	1	Adaptador puntas 1/4"	1	Adap. puntas 1/4"
10	Vasos 4 a 13 mm	1	Alargadera 75 mm		
15	Puntas	3	5, 6, 8 mm	3	4, 5'5, 6'5 mm
		3	PH1, PH2, PH3	3	PZ1, PZ2, PZ3
		3	T15, T20, T25		



Code	Nº Piezas	P.V.P. unid. €	
<b>192195</b>	29	<b>44,00</b>	6

## Juego de Vasos de 1/4" pasantes

ACERO  
CR-V



Dimensión caja: 335x175x50 mm

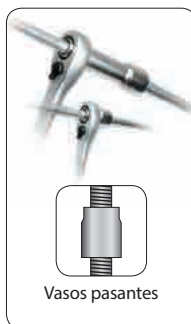

Vasos pasantes



COMPOSICION			
Vasos pasantes	8 Vasos pasantes 10 a 19 mm	1 Alargadera pasante 75 mm	
	1 Adaptador para carraca pasante para vasos de 1/4"		
Vasos 1/4"	13 Vasos 4 a 14 mm	1 Alargadera 50 mm	1 Atornillador con carraca y cabeza flexible
	1 Adaptador puntas 1/4"	1 Carraca pasante 1/4"	
Puntas 5/16"	20 Puntas		
	4 3, 4, 5, 6, mm	3 4, 5, 5, 7 mm	3 PH1, PH2, PH3
		3 PZ1, PZ2, PZ3	7 T8, T10, T15, T20, T25, T27, T30



Code	Nº Piezas	P.V.P. unid. €	
<b>192182</b>	47	<b>70,87</b>	5

## Carraca de 1/4" con mango extensible

ACERO  
CR-V

Carraca extensible



- Con expulsor de vasos y reversor
- Longitud ajustable a 6 medidas entre 150 y 200 mm



Code	L mm	P.V.P. unid. €	
<b>192139</b>	150/200	<b>23,67</b>	5

Se suministra en colgador

## Carraca de 1/4"

ACERO  
CR-V



- Con expulsor de vasos y reversor



Code	L mm	P.V.P. unid. €	
<b>192138</b>	153	<b>18,00</b>	5

Se suministra en colgador

## Carraca corta de 1/4"

ACERO  
CR-V



- Con expulsor de vasos y reversor



Code	L mm	P.V.P. unid. €	
<b>192136</b>	112	<b>14,91</b>	5

Se suministra en colgador

## Carraca dual de 1/4"

ACERO  
CR-V



- 1 Para utilizar con vasos de 1/4"
- 2 Para utilizar con puntas de 1/4"

- Con reversor



Code	L mm	P.V.P. unid. €	
<b>192133</b>	112	<b>15,84</b>	5

Se suministra en colgador

## Llave de Vaso de 1/4"

DIN  
3124

ACERO  
CR-V

• Terminación cromado mate

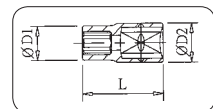

Code	mm	L mm	D1 mm	D2 mm	P.V.P. unid. €	
192101	4	25	6,8	11,9	1,74	10
192102	4,5	25	7,1	11,9	1,74	10
192103	5	25	8	11,9	1,74	10
192104	5,5	25	8,3	11,9	1,74	10
192105	6	25	9,3	11,9	1,74	10
192106	7	25	10,5	11,9	1,74	10
192107	8	25	11,9	11,9	1,74	10
192108	9	25	12,9	12,9	1,74	10
192109	10	25	13,9	13,9	1,88	10
192110	11	25	15,8	15,8	1,88	10
192111	12	25	16,8	16,8	1,98	10
192112	13	25	17,8	17,8	2,59	10
192113	14	25	17,5	17,8	2,73	10

Code	mm	L mm	D1 mm	D2 mm	P.V.P. unid. €	
190250	5/32"	21	6,9	11,9	1,74	1
190252	3/16"	21	7,5	11,9	1,74	1
190254	7/32"	21	8,1	11,9	1,74	1
190256	1/4"	21	9,9	11,9	1,74	1
190258	9/32"	21	11,9	11,9	1,74	1
190260	5/16"	21	11,9	11,9	1,74	1
190262	11/32"	21	12,9	12,9	1,74	1
190264	3/8"	21	13,9	13,9	1,88	1
190266	7/16"	21	16,2	16,2	1,88	1
190268	1/2"	21	18,9	18,9	1,92	1
190270	9/16"	21	19,9	19,9	2,59	1

## Juego de vasos 1/4", regleta de plástico

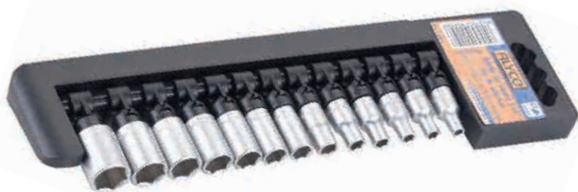

### COMPOSICION

Vasos de 4, 4'5, 5, 5'5, 6, 7, 8, 9, 10, 11, 12, 13, 14 mm

Code	Nº piezas	P.V.P. unid. €	
192119	13	19,60	1

## Llave de Vaso de 1/4", Serie larga

DIN  
3124

ACERO  
CR-V

SERIE LARGA

• Terminación cromado mate



Code	mm	L mm	D1 mm	D2 mm	P.V.P. unid. €	
192120	6	50	9,3	11,9	3,44	10
192121	7	50	10,5	11,9	3,44	10
192122	8	50	11,9	11,9	3,44	10
192124	10	50	14,5	14,5	3,44	10
192126	12	50	16,8	16,8	3,65	10
192127	13	50	17,8	17,8	3,92	10

Code	mm	L mm	D1 mm	D2 mm	P.V.P. unid. €	
190280	1/4"	50	10,3	11,9	3,44	1
190282	9/32"	50	10,6	11,9	3,44	1
190284	5/16"	50	11,9	11,9	3,44	1
190286	3/8"	50	14,7	14,7	3,44	1
190288	7/16"	50	16,5	16,5	3,65	1
190290	1/2"	50	17,9	17,9	3,92	1

## Llave de Vaso 1/4" Torx Hembra (tipo E)

ACERO  
CR-V

• Terminación cromado mate



Code		L mm	P.V.P. unid. €	
192114	E4	27	2,21	10
192115	E5	27	2,21	10
192116	E6	27	2,21	10
192117	E7	27	2,21	10
192118	E8	27	2,21	10

## Vaso con punta de 1/4"



Code	Ø mm	Ø mm	P.V.P. unid. €	
192014	4	0,8	2,84	10
192015	5,5	1	2,84	10
192016	6,5	1,2	2,84	10
192018	8	1,2	2,84	10

Code	Ø mm	P.V.P. unid. €	
192003	3	2,84	10
192004	4	2,84	10
192005	5	2,84	10
192006	6	2,84	10
192008	8	2,84	10

Code		P.V.P. unid. €	
192040	T6	3,12	10
192041	T7	3,12	10
192042	T8	3,12	10
192043	T9	3,12	10
192044	T10	3,12	10
192045	T15	3,12	10
192046	T20	3,12	10
192047	T25	3,12	10
192039	T27	3,12	10 <span style="background-color: yellow;">Nuevo</span>
192048	T30	3,12	10
192049	T40	3,12	10

ACERO CR-V

LONGITUD 37 MM

Code		P.V.P. unid. €	
192021	PH1	2,84	10
192022	PH2	2,84	10
192023	PH3	2,84	10

Code		P.V.P. unid. €	
192031	PZ1	2,84	10
192032	PZ2	2,84	10
192033	PZ3	2,84	10

Code		P.V.P. unid. €	
192064	M4	2,84	10
192065	M5	2,84	10
192066	M6	2,84	10
192068	M8	2,84	10

Code		P.V.P. unid. €	
192051	T6	4,10	10
192052	T7	4,10	10
192053	T8	4,10	10
192054	T9	4,10	10
192055	T10	4,10	10
192056	T15	4,10	10
192057	T20	4,10	10
192058	T25	4,10	10
192059	T30	4,10	10
192060	T40	4,10	10

## Regleta de Vasos de 1/4" con punta



### COMPOSICION

- 3, 4, 5, 6, 8 mm
- ⊕ PH1, PH2, PH3
- 0'8x4, 1x5'5, 1'2x6'5, 1'2x8 mm

Code	Nº piezas	P.V.P. unid. €	
192050	12	28,70	1

## Expositor de Vasos de 1/4"



### COMPOSICION

- 120** Vasos de 1/4" (10 unidades de cada medida)  
192101, 192102, 192103, 192104, 192105, 192106, 192107, 192108, 192109, 192110, 192111, 192112
- 130** Vasos con punta y largos 1/4" (10 unidades de cada medida)  
192021, 192022, 192003, 192004, 192005, 192006, 192008, 192014, 192015, 192016, 192122, 192124, 192127

Code	Nº piezas	P.V.P. unid. €	
192100	250	615,00	1



## Accesorios para vasos de 1/4"



### Atornillador-alargadera con mango

DIN 3122

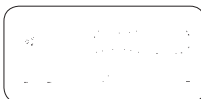

### Mango atornillador flexible

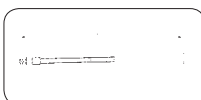

### Alargadera

DIN 3123



Con hexágono exterior

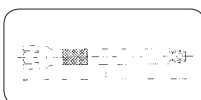

### Alargadera flexible

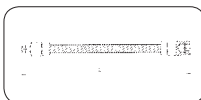

### Mango en T

DIN 3123



### Junta universal

DIN 3123

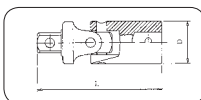

### Adaptador para puntas de 1/4"

DIN 3121

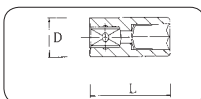

### Adaptador 1/4"H x 3/8"M

DIN 3123



• Terminación cromado mate



Code	L mm	P.V.P. unid. €	
<b>192145</b>	150	<b>6,43</b>	6

Code	L mm	P.V.P. unid. €	
<b>192155</b>	200	<b>11,98</b>	6

Sólo para aprietes a la derecha. Con hexágono exterior

Code	L mm	P.V.P. unid. €	
<b>192160</b>	50	<b>4,06</b>	6
<b>192161</b>	75	<b>5,80</b>	6
<b>192162</b>	100	<b>6,16</b>	6
<b>192163</b>	150	<b>7,21</b>	6

Code	L mm	P.V.P. unid. €	
<b>192150</b>	150	<b>9,57</b>	6

Sólo para aprietes a la derecha. Con hexágono exterior

Code	L mm	P.V.P. unid. €	
<b>192164</b>	100	<b>6,46</b>	6

Code	L mm	D mm	P.V.P. unid. €	
<b>192165</b>	40	14	<b>9,00</b>	10

Code	L mm	D mm	P.V.P. unid. €	
<b>192170</b>	25	12	<b>3,00</b>	10

Con muelle de retención de puntas

Code	Hembra	Macho	P.V.P. unid. €	
<b>192605</b>	1/4"	3/8"	<b>3,20</b>	10

## Juego de Vasos de 3/8"

ACERO  
CR-V

Carraca  
extensible



Dimensión caja: 365x240x85 mm

### COMPOSICION

1	Carraca extensible (192244)	2	Alargaderas 75, 125 mm	1	Adapt. vasos 3/8"
14	Vasos 8 a 22 mm	1	Junta universal	1	Adaptador puntas 1/4"
6	Vasos largos 8, 10, 12, 13, 17, 19 mm	1	Adaptador 3/8" M x 1/2" H		
2	Llaves bujía 16, 21 mm	1	Adap. puntas 1/4"		
24	Puntas 1/4"				

### CON ADAPTADORES PARA HERRAMIENTA ELECTRICA Y NEUMATICA



Code	Nº Piezas	P.V.P. unid. €	
<b>192287</b>	54	<b>92,50</b>	1

## Carraca de 3/8" con mango extensible

ACERO  
CR-V

Carraca  
extensible

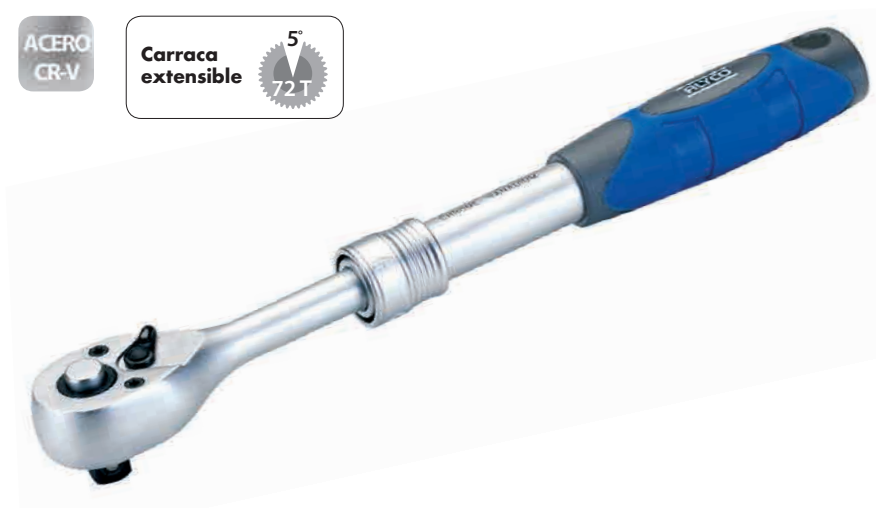

- Con expulsor de vasos y reversor
- Mango ergonómico bimatereial
- Longitud ajustable a 6 medidas entre 215 y 315 mm



Code	L mm	P.V.P. unid. €	
<b>192244</b>	215/315	<b>29,00</b>	5

Se suministra en colgador

## Carraca de 3/8"

ACERO  
CR-V



- Con expulsor de vasos y reversor



Code	L mm	P.V.P. unid. €	
<b>192243</b>	202	<b>23,00</b>	5

Se suministra en colgador

## Carraca corta de 3/8"

ACERO  
CR-V



Code	L mm	P.V.P. unid. €	
<b>192246</b>	140	<b>18,68</b>	5

Se suministra en colgador

## Llave de Vaso de 3/8"

ACERO  
CR-V

DIN  
3124

SERIE NORMAL



• Terminación  
cromado mate

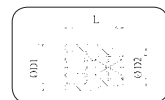

Code	mm	L mm	D1 mm	D2 mm	P.V.P. unid. €	
192208	8	28	11,8	16,8	2,30	10
192209	9	28	13,2	16,8	2,36	10
192210	10	28	14,5	16,8	2,46	10
192211	11	28	15,7	16,8	2,52	10
192212	12	28	16,8	16	2,54	10
192213	13	28	17,8	16,5	2,60	10
192214	14	28	19,6	17	2,78	10
192215	15	28	20,8	18	2,88	10
192216	16	30	21,8	19	3,02	10
192217	17	30	23,4	20	3,19	10
192218	18	30	24,6	21	3,26	10
192219	19	30	25,8	23	3,38	10
192221	21	32	27,8	25	3,52	10
192222	22	32	29,6	26	3,62	10



SERIE LARGA



Code	mm	L mm	D1 mm	D2 mm	P.V.P. unid. €	
192228	8	63	11,8	16,9	3,91	10
192230	10	63	14,5	16,9	3,92	10
192232	12	63	16,9	16	4,07	10
192233	13	63	17,9	16,5	4,15	10
192237	17	63	23,4	20	4,97	10
192239	19	63	25,8	23	5,24	10

## Juego de vasos 3/8", regleta de plástico



### COMPOSICION

8, 9, 10, 11, 12, 13, 14, 15, 16, 17, 18 mm



Code	Nº piezas	P.V.P. unid. €	
192225	11	23,10	1

## Alargadera

DIN  
3123



Con hexágono exterior

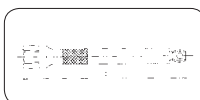

Code	L mm	P.V.P. unid. €	
192250	75*	9,37	6
192255	75	6,68	6
192260	150	8,27	6

\* Alargadera angular, con cuadradillo redondeado

## Junta universal

DIN  
3123

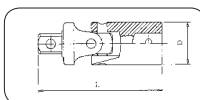

Code	L mm	D mm	P.V.P. unid. €	
192265	54	16	11,00	6

## Adaptador

DIN  
3123



Code	Hembra	Macho	P.V.P. unid. €	
192610	3/8"	1/4"	4,50	10
192615	3/8"	1/2"	5,90	10

Con agujero para mango en T

## Llave de bujía



Code	mm	P.V.P. unid. €	
192275	16	6,44	6
192276	21	8,95	6

## Adaptador para puntas

DIN  
3123



Para carraca 3/8"  
para puntas 1/4"



Para carraca 3/8"  
para puntas 3/8"



Code	para puntas	P.V.P. unid. €	
192270	1/4"	5,00	6
186185	3/8"	5,72	6

## Juego de Vasos de 1/2" - 1/4" - 3/8" combinado

ACERO  
CR-V

Carracas extensibles  
1/2" y 3/8"  
5°  
72 T

CAJA CON CIERRES Y  
BISAGRAS METALICAS



Dimensión caja: 440x370x110 mm

COMPOSICION 1/2"		
17 Vasos 10 a 32 mm	1 Junta universal	1 Adaptador puntas 5/16"
5 Vasos largos 14, 15, 17, 19, 22 mm	2 Llaves bujía 16, 21 mm	2 Alargaderas 125, 250 mm
3 Vasos torx hembra E20, E22, E24	1 Carraca extensible (192344)	
COMPOSICION 3/8"		
10 Vasos 10 a 19 mm	1 Junta universal	1 Adaptador puntas 1/4"
6 Vasos largos 10, 11, 12, 13, 14, 15 mm	1 Llave bujía 16 mm	2 Alargaderas 75, 150 mm
5 Vasos torx hembra E10, E12, E14, E16, E18	1 Carraca extensible	10 Vasos con puntas 5 6, 7, 8, 9, 10 mm
COMPOSICION 1/4"		
13 Vasos 4 a 14 mm	1 Junta universal	1 Carraca (192138)
7 Vasos largos 4, 5, 6, 7, 8, 9, 10 mm	2 Alargaderas 50, 100 mm	1 Atornillador 150 mm
5 Vasos torx hembra E4, E5, E6, E7, E8		
30 Vasos con puntas		
5 3, 4, 5, 6, 7 mm	6 3, 4, 4'5, 5, 5'5, 6, 6'5, 7 mm	4 PH0, PH1 PH2, PH3
		4 PZ0, PZ1 PZ2, PZ3
		9 T8, T9, T10, T15, T20, T25, T27, T30, T40
21 Puntas 5/16"		
7 4, 5, 6, 7, 8, 10, 12 mm	2 PH2, PH3	7 T20, T25, T30 T40, T45, T50, T55
		5 M5, M6, M8, M10, M12
5 Llaves allen 1'25, 1'5, 2, 2'5, 3 mm		



Code	Nº piezas	P.V.P. unid. €	
<b>192386</b>	155	<b>255,35</b>	2

## Juego de Vasos de 1/4" y 1/2"

ACERO  
CR-V

Carracas extensibles  
1/4" y 1/2"  
5°  
72 T

CAJA CON CIERRES Y  
BISAGRAS METALICAS



Dimensión caja: 365x240x85 mm

COMPOSICION 1/2"		
13 Vasos 10, 11, 12, 13, 14, 15, 17, 19, 22, 24, 27, 30, 32 mm	2 Alargaderas 125, 250 mm	1 Adaptador 3/8" H x 1/2" M
1 Carraca extensible (192344)	1 Adaptador puntas 5/16"	1 Adaptador vasos 1/2"
COMPOSICION 1/4"		
12 Vasos 4, 4'5, 5, 5'5, 6, 7, 8, 9, 10, 11, 12, 13 mm	2 Alargaderas 50, 100 mm	1 Adaptador 3/8" H x 1/4" M
1 Carraca extensible (192139)	1 Adap. puntas 5/16"	1 Adaptador vasos 1/4"
12 Vasos con puntas		
2 4, 5, 5 mm	2 PH1, PH2	5 T15, T20, T25 T27, T30
		3 4, 5, 6 mm
12 Puntas 5/16"		
2 7, 8 mm	2 PH3, PH4	5 T40, T45, T50 T55, T60
		3 8, 10, 12 mm
5 Llaves allen 1'25, 1'5, 2, 2'5, 3 mm		



Code	Nº piezas	P.V.P. unid. €	
<b>192389</b>	66	<b>126,86</b>	1

## Juego de Vasos de 1/2"

ACERO  
CR-V

Carraca extensible  
5  
72T



Dimensión caja: 365x240x85 mm

### CON ADAPTADORES PARA HERRAMIENTA ELECTRICA Y NEUMATICA

#### COMPOSICION

1 Carraca extensible (192344)	1 Junta universal	1 Adaptador vasos 1/2"
16 Vasos 10 a 32 mm	1 Adaptador 3/8"H x 1/2"M	1 Adaptador puntas 5/16"
2 Alargaderas 125, 250 mm	1 Adapt. puntas 5/16"	
24 Puntas 5/16"		
6 4, 5, 6, 8, 10, 12 mm	4 5/5, 7, 8, 10 mm	4 PH1, PH2, PH3, PH4
	4 PZ1, PZ2, PZ3, PZ4	6 T30, T40, T45, T50, T55, T60



Code	Nº piezas	P.V.P. unid. €	
192384	48	104,78	1

## Juego de Vasos de 1/2"- pulgadas

ACERO  
CR-V



Carraca extensible  
5  
72T



Dimensión caja: 365x240x85 mm

### CON ADAPTADORES PARA HERRAMIENTA ELECTRICA Y NEUMATICA

#### COMPOSICION

1 Carraca extensible (192344)	1 Junta universal	2 Alargaderas 125, 250 mm
15 Vasos 3/8", 7/16", 1/2", 9/16", 5/8", 11/16", 3/4", 13/16", 7/8", 15/16", 1", 1-1/16", 1-1/8", 1-3/16", 1-1/4"	1 Adaptador 3/8"H x 1/2"M	1 Adapt. vasos 1/2"
24 Puntas 5/16"	1 Adap. puntas 5/16"	1 Adaptador puntas 5/16"
6 4, 5, 6, 8, 10, 12 mm	4 5/5, 7, 8, 10 mm	4 PH1, PH2, PH3, PH4
	4 PZ1, PZ2, PZ3, PZ4	6 T30, T40, T45, T50, T55, T60



Code	Nº piezas	P.V.P. unid. €	
190240	47	104,78	1

## Juego de Vasos de 1/2"

ACERO  
CR-V

Carraca extensible  
5  
72T



Dimensión caja: 330x160x60 mm

### CAJA CON CIERRES Y BISAGRAS METALICAS

#### COMPOSICION

10 Vasos 10 a 19 mm	1 Adaptador puntas 5/16"
1 Alargadera 125 mm	1 Carraca extensible (192344)
25 Puntas 5/16"	
7 4, 5, 6, 7, 8, 10, 12 mm	3 5/5, 6/5, 8 mm
	3 PH1, PH2, PH3
	3 PZ1, PZ2, PZ3
	9 T10, T15, T20, T25, T30, T40, T45, T50, T55



Code	Nº piezas	P.V.P. unid. €	
192383	38	68,93	1

## Carraca de 1/2" con mango extensible

ACERO  
CR-V

Carraca  
extensible



Agujero para colgar

Mango bimaterial de gran grosor para una mejor transmisión del par

Botón expulsor de vasos

Anilla con la que se fija la longitud de la carraca

Reversor

Cabeza cerrada. Evita la entrada de suciedad en el mecanismo interno

Mango perforado para permitir el ajuste seguro de la carraca a diferentes longitudes

**POSIBILIDAD DE AJUSTE A 6 LONGITUDES DIFERENTES**

1/2

Code	L mín./L máx mm	P.V.P. unid. €	
<b>192344</b>	302/442	<b>41,31</b>	3

Se suministra con colgador

## Carraca de 1/2" flexible con mango extensible

ACERO  
CR-V

Carraca  
extensible



**POSIBILIDAD DE AJUSTE A 6 LONGITUDES DIFERENTES**

Mismas características que la carraca 192344

1/2

**CABEZA FLEXIBLE CON POSIBILIDAD DE GIRO DE 180° CON 10 POSICIONES FIJAS**

Code	L mín./L máx mm	P.V.P. unid. €	
<b>192347</b>	302/442	<b>46,66</b>	3

Se suministra con colgador

## Carraca de 1/2"

ACERO  
CR-V



## Carraca corta de 1/2"

ACERO  
Cr-V



• Con expulsor de vasos y reversor

1/2

• Con expulsor de vasos y reversor

Code	L mm	P.V.P. unid. €	
<b>192343</b>	270	<b>28,00</b>	3

Se suministra con colgador

Code	L mm	P.V.P. unid. €	
<b>192348</b>	174	<b>22,13</b>	5

Se suministra con colgador

## Llave de Vaso de 1/2"

DIN  
3124



ACERO  
CR-V

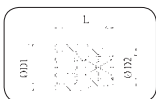

• Terminación cromado mate

Code	Ø mm	L mm	P.V.P. unid. €		Code	Ø mm	L mm	P.V.P. unid. €	
192308	8	38	2,38	10	192320	20	38	4,08	10
192310	10	38	2,76	10	192321	21	38	4,08	10
192311	11	38	2,81	10	192322	22	38	4,32	10
192312	12	38	2,96	10	192323	23	40	4,43	10
192313	13	38	3,08	10	192324	24	42	4,66	10
192314	14	38	3,35	10	192325	25	42	4,76	10
192315	15	38	3,40	10	192326	26	42	4,91	10
192316	16	38	3,44	10	192327	27	43	5,07	10
192317	17	38	3,57	10	192328	28	46	5,15	5
192318	18	38	3,57	10	192329	29	46	5,25	5
192319	19	38	3,68	10	192330	30	46	5,66	5
					192332	32	46	5,77	5

Code	Ø	L mm	P.V.P. unid. €		Code	Ø	L mm	P.V.P. unid. €	
190202	3/8"	38	2,76	1	190216	13/16"	38	4,08	1
190204	7/16"	38	2,81	1	190218	7/8"	38	4,32	1
190206	1/2"	38	2,96	1	190220	15/16"	38	4,43	1
190208	9/16"	38	3,35	1	190222	1"	41	4,66	1
190210	5/8"	38	3,43	1	190224	1-1/16"	42	5,08	1
190212	11/16"	38	3,57	1	190226	1-1/8"	42	5,27	1
190214	3/4"	38	3,68	1	190228	1-3/16"	44	5,66	1
					190230	1-1/4"	44	5,77	1

## Llave de Vaso de 1/2"

DIN  
3124



ACERO  
CR-V

SERIE LARGA



Code	Ø mm	L mm	P.V.P. unid. €		Code	Ø mm	L mm	P.V.P. unid. €	
<b>Nuevo</b> 190498	8	77	7,15	5	192511	20	77	8,48	5
192501	10	77	7,26	5	192512	21	77	8,48	5
192502	11	77	7,36	5	192513	22	77	9,45	5
192503	12	77	7,36	5	<b>Nuevo</b> 190523	23	77	9,60	5
192504	13	77	7,51	5	192514	24	77	9,86	5
192505	14	77	8,28	5	<b>Nuevo</b> 190525	25	77	10,00	5
192506	15	77	8,28	5	<b>Nuevo</b> 190526	26	77	10,30	5
192507	16	77	8,28	5	192515	27	77	10,51	3
192508	17	77	8,28	5	<b>Nuevo</b> 190528	28	77	11,20	3
192509	18	77	8,28	5	<b>Nuevo</b> 190529	29	77	11,80	3
192510	19	77	8,28	5	192516	30	77	12,05	3
					192517	32	77	13,05	3

## Llave de Vaso de 1/2", bihexagonal

DIN  
3124



ACERO  
CR-V

12 caras



Code	Ø mm	L mm	P.V.P. unid. €		Code	Ø mm	L mm	P.V.P. unid. €	
<b>Nuevo</b> 190408	8	38	2,75	10	190420	20	38	4,08	10
190410	10	38	2,77	10	190421	21	38	4,08	10
190411	11	38	2,81	10	190422	22	38	4,32	10
190412	12	38	2,96	10	190423	23	40	4,43	10
190413	13	38	3,07	10	190424	24	42	4,66	10
190414	14	38	3,35	10	<b>Nuevo</b> 190425	25	42	4,80	10
190415	15	38	3,40	10	<b>Nuevo</b> 190426	26	43	4,95	10
190416	16	38	3,44	10	190427	27	43	5,06	10
190417	17	38	3,57	10	<b>Nuevo</b> 190428	28	43	5,25	5
190418	18	38	3,57	10	<b>Nuevo</b> 190429	29	46	5,50	5
190419	19	38	3,68	10	190430	30	46	5,66	5
					190432	32	46	5,77	5

## Llave de Vaso de 1/2", bihexagonal

DIN 3124



ACERO CR-V

**Nuevo**



SERIE LARGA



Code	Ø mm	L mm	P.V.P. unid. €	
190678	8	77	7,15	5
190680	10	77	7,26	5
190681	11	77	7,36	5
190682	12	77	7,36	5
190683	13	77	7,51	5
190684	14	77	8,28	5
190685	15	77	8,28	5
190686	16	77	8,28	5
190687	17	77	8,28	5
190688	18	77	8,28	5
190689	19	77	8,28	5

Code	Ø mm	L mm	P.V.P. unid. €	
190690	20	77	8,48	5
190691	21	77	8,48	5
190692	22	77	9,45	5
190693	23	77	9,60	5
190694	24	77	9,86	5
190695	25	77	10,00	5
190696	26	77	10,30	5
190697	27	77	10,51	5
190698	28	77	11,20	5
190699	29	77	11,80	5
190700	30	77	12,05	5
190702	32	77	13,05	5

## Llave de Vaso de 1/2" Torx Hembra (Tipo E)

ACERO CR-V



• Terminación cromado mate

Code		L mm	P.V.P. unid. €	
192294	E10	38	4,11	4
192295	E12	38	4,11	4
192296	E14	38	4,11	4
192297	E16	38	4,26	4
192298	E18	38	4,26	4
192299	E20	38	4,58	4
192300	E24	38	5,06	4

## Juego de vasos 1/2", regleta de plástico



SERIE NORMAL



192518 (6 caras)  
190703 (12 caras)

SERIE LARGA



### COMPOSICION

192333 10, 11, 12, 13, 14, 15, 16, 17, 18, 19 mm  
192334 17, 19, 20, 21, 22, 24, 27, 30, 32 mm

Code	Nº piezas	P.V.P. unid. €	
192333	10	26,60	1
192334	9	30,10	1

### COMPOSICION

10, 11, 13, 14, 15, 16, 17, 19, 21, 22 mm

Code	Nº piezas	P.V.P. unid. €	
192518	10	65,10	1
190703	10	65,10	1

### COMPOSICION

10, 11, 13, 14, 15, 16, 17, 19, 21, 22 mm

Code	Nº piezas	P.V.P. unid. €	
190433	10	28,80	1

## Expositor de Vasos de 1/2"



Longitud del expositor: 770 mm

### COMPOSICION

**150** Vasos de 1/2" (10 unidades de cada medida)  
192310, 192311, 192312, 192313, 192314, 192315, 192316, 192317, 192318, 192319, 192320, 192321, 192322, 192323, 192324  
**40** Vasos de 1/2" (5 unidades de cada medida)  
192327, 192330, 192332, 192501, 192504, 192508, 192510, 192514 (Serie larga)  
1 Expositor de vasos / 23 Separadores metálicos

Code	Nº piezas	P.V.P. unid. €	
192305	190	895,00	1



## Accesorios para vasos de 1/2"

ACERO  
CR-V

• Terminación cromado mate

1/2

### Mango articulado



Posibilidad de giro de la articulación a diferentes ángulos entre 0° y 180°

Code	L mm	P.V.P. unid. €	
<b>192362</b>	385	<b>23,00</b>	1

### Alargadera

DIN  
3123



Con hexágono exterior

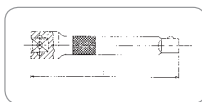

Code	L mm	P.V.P. unid. €	
<b>192352</b>	75	<b>5,10</b>	6
<b>192355</b>	125	<b>5,94</b>	6
<b>192356</b>	150	<b>6,62</b>	6
<b>192358</b>	250	<b>9,78</b>	6

### Alargadera con bloqueo



#### MODO DE EMPLEO



Anilla levantada, alargadera desbloqueada. Se puede soltar el vaso.



Anilla bajada, alargadera bloqueada en el vaso.

Code	L mm	P.V.P. unid. €	
<b>192359</b>	125	<b>9,21</b>	5

Permite una sujeción segura entre alargadera y vaso

### Mango en T

DIN  
3122

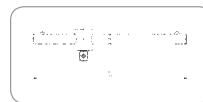

Code	L mm	P.V.P. unid. €	
<b>192360</b>	250	<b>12,28</b>	6

### Junta universal

DIN  
3123

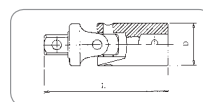

Code	L mm	P.V.P. unid. €	
<b>192365</b>	73,5	<b>10,00</b>	6

### Adaptador

DIN  
3123



Code	Hembra	Macho	P.V.P. unid. €	
<b>192620</b>	1/2" *	3/8"	<b>6,00</b>	10
<b>192625</b>	1/2"	3/4"	<b>9,50</b>	10

\* Con agujero pasante para mango en T

### Adaptador para puntas

DIN  
3121



Para carraca de 1/2" para puntas 5/16"



Para carraca de 1/2" para puntas 3/8"

Code	para puntas	P.V.P. unid. €	
<b>192363</b>	5/16"	<b>5,00</b>	4
<b>186187</b>	3/8"	<b>4,00</b>	6

## Llave de Vaso de 1/2", Allen

DIN  
3121

ACERO  
CR-V



Code	mm	L mm	P.V.P. unid. €	
192405	5	55	6,13	10
192406	6	55	6,13	10
192407	7	55	6,24	10
192408	8	55	6,30	10
192409	9	55	6,34	10
192410	10	55	6,37	10
192412	12	55	6,57	10
192414	14	55	7,30	10
192417	17	55	9,37	10

## Juego de vasos 1/2", punta Allen

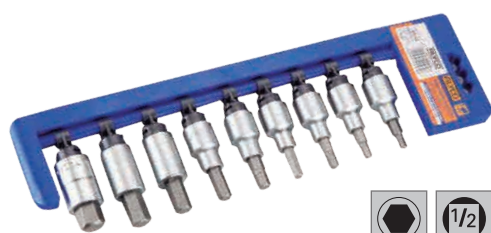

### COMPOSICION

5, 6, 7, 8, 9, 10, 12, 14, 17 mm

Code	Nº piezas	P.V.P. unid. €	
192470	9	50,00	1

## Llave de Vaso de 1/2", Torx

DIN  
3121

ACERO  
CR-V



Code	mm	L mm	P.V.P. unid. €	
190720	T20	55	7,17	10
190725	T25	55	7,19	10
190727	T27	55	7,25	10
190730	T30	55	7,28	10
190740	T40	55	7,31	10
190745	T45	55	7,42	10
190750	T50	55	7,88	10
190755	T55	55	7,91	10
190760	T60	55	8,07	10

## Llave de Vaso de 1/2", Torx inviolable

DIN  
3121

ACERO  
CR-V



Code	mm	L mm	P.V.P. unid. €	
192420	T20	55	7,17	10
192425	T25	55	7,19	10
192427	T27	55	7,25	10
192430	T30	55	7,28	10
192440	T40	55	7,31	10
192445	T45	55	7,42	10
192450	T50	55	7,88	10
192455	T55	55	7,91	10
192460	T60	55	8,07	10

## Juego de vasos 1/2", punta Torx inviolable

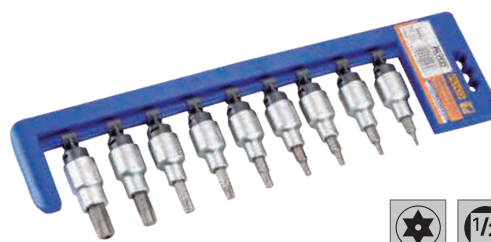

### COMPOSICION

T20, T25, T27, T30, T40, T45, T50, T55, T60

Code	Nº piezas	P.V.P. unid. €	
192480	9	54,00	1

## Juego de vasos 1/2", punta Torx



### COMPOSICION

T20, T25, T27, T30, T40, T45, T50, T55, T60

Code	Nº piezas	P.V.P. unid. €	
190765	9	54,00	1

## Llave de Vaso de 1/2", XZN

DIN  
3120



ACERO  
CR-V



Code		L mm	P.V.P. unid. €	
<b>192481</b>	M6	55	<b>8,05</b>	10
<b>192482</b>	M8	55	<b>8,21</b>	10
<b>192483</b>	M10	55	<b>8,47</b>	10
<b>192484</b>	M12	55	<b>9,04</b>	10
<b>192485</b>	M14	55	<b>9,37</b>	10
<b>192486</b>	M16	55	<b>10,46</b>	10

## Llave de Vaso de 1/2", RIBE

DIN  
3120



ACERO  
CR-V



Code		L mm	P.V.P. unid. €	
<b>190767</b>	M7	55	<b>6,24</b>	10
<b>190770</b>	M10	55	<b>6,30</b>	10
<b>190774</b>	M14	55	<b>6,34</b>	10
<b>190776</b>	M16	55	<b>9,37</b>	10

## Llave de Vaso de 1/2", Allen largo

DIN  
3121



ACERO  
CR-V

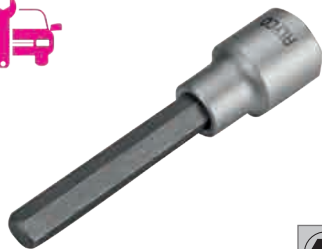

Code		L mm	P.V.P. unid. €	
<b>190705</b>	5	100	<b>6,13</b>	10
<b>190706</b>	6	100	<b>6,13</b>	10
<b>190707</b>	7	100	<b>6,24</b>	10
<b>190708</b>	8	100	<b>6,30</b>	10
<b>190710</b>	10	100	<b>6,34</b>	10
<b>190712</b>	12	100	<b>9,37</b>	10

## Llave de Vaso de 1/2", Torx largo

DIN  
3121



ACERO  
CR-V



Code		L mm	P.V.P. unid. €	
<b>190741</b>	T40	100	<b>6,13</b>	10
<b>190746</b>	T45	100	<b>6,24</b>	10
<b>190751</b>	T50	100	<b>6,30</b>	10
<b>190756</b>	T55	100	<b>6,34</b>	10
<b>190761</b>	T70	100	<b>9,37</b>	10

## Llave de Vaso de 1/2", XZN largo

DIN  
3121



ACERO  
CR-V



Code		L mm	P.V.P. unid. €	
<b>192475</b>	M6	100	<b>6,24</b>	10
<b>192476</b>	M8	100	<b>6,30</b>	10
<b>192477</b>	M10	100	<b>6,34</b>	10
<b>192478</b>	M12	100	<b>9,37</b>	10

## Llave de Vaso de 1/2", RIBE largo

DIN  
3121



ACERO  
CR-V



Code		L mm	P.V.P. unid. €	
<b>190768</b>	M7	100	<b>8,05</b>	10
<b>190771</b>	M10	100	<b>8,21</b>	10
<b>190775</b>	M14	100	<b>8,47</b>	10
<b>190777</b>	M16	100	<b>10,46</b>	10

## Juego de vasos de 1/4" aislados



### Certificado VDE

#### NORMA EN 60900

Herramientas aisladas utilizadas para trabajos en tensiones de hasta 1000V en Corriente Alterna ó 1500 V en Corriente Continua



#### COMPOSICION

10 Vasos aislados 1/4" 5 a 14	2 Alargaderas aisladas 100, 150 mm	1 Carraca aislada
4 Vasos aislados punta hexagonal 3 a 6	1 Mango en T aislado 125 mm	

Code	Nº piezas	P.V.P. unid. €	
<b>190302</b>	18	<b>239,00</b>	1

## Carraca de 1/4" aislada



### Certificado VDE



- Mango y cuerpo de la carraca recubiertos de material aislante
- Carraca con expulsor de vasos y reversible
- Mango bimaterial con forma ergonómica



Code	L mm	P.V.P. unid. €	
<b>190390</b>	150	<b>49,00</b>	1

## Vaso de 1/4" aislado



Code	mm	L mm	P.V.P. unid. €	
<b>190383</b>	3	55	<b>6,01</b>	1
<b>190384</b>	4	55	<b>6,01</b>	1
<b>190385</b>	5	55	<b>6,01</b>	1
<b>190386</b>	6	55	<b>6,01</b>	1



### Certificado VDE



Code	mm	L mm	P.V.P. unid. €	
<b>190365</b>	5	40	<b>4,98</b>	1
<b>190366</b>	6	40	<b>4,98</b>	1
<b>190367</b>	7	40	<b>4,98</b>	1
<b>190368</b>	8	40	<b>4,98</b>	1
<b>190369</b>	9	40	<b>4,98</b>	1
<b>190370</b>	10	40	<b>4,98</b>	1
<b>190371</b>	11	40	<b>5,08</b>	1
<b>190372</b>	12	40	<b>5,12</b>	1
<b>190373</b>	13	40	<b>5,19</b>	1
<b>190374</b>	14	40	<b>5,21</b>	1

## Alargadera y mango en T de 1/4" aislados



### Certificado VDE



Code	Tipo	L mm	P.V.P. unid. €	
<b>190392</b>	<b>ALARGADERA</b>	100	<b>16,83</b>	1
<b>190393</b>	<b>ALARGADERA</b>	150	<b>18,89</b>	1
<b>190391</b>	<b>MANGO EN T</b>	125	<b>29,20</b>	1

## Juego de vasos de 1/2" aislados

ACERO  
CR-V



## Certificado VDE

### NORMA EN 60900

Herramientas aisladas utilizadas para trabajos en tensiones de hasta 1000V en Corriente Alterna ó 1500 V en Corriente Continua



### COMPOSICION

<b>11</b> Vasos aislados 1/2" 10 a 32	<b>2</b> Alargaderas aisladas 125, 250 mm	<b>1</b> Carraca aislada
<b>5</b> Vasos aislados 1/2" punta hexagonal 4 a 10	<b>1</b> Mango en "T" aislado	

Code	Nº piezas	P.V.P. unid. €	
<b>190300</b>	20	<b>365,00</b>	1

## Carraca de 1/2" aislada



## Certificado VDE



- Mango y cuerpo de la carraca recubiertos de material aislante
- Carraca con expulsor de vasos y reversible
- Mango bimaternal con forma ergonómica

Code	L mm	P.V.P. unid. €	
<b>190305</b>	250	<b>75,00</b>	1

## Vaso de 1/2" aislado



## Certificado VDE



	Code	mm	L mm	P.V.P. unid. €	
<b>Nuevo</b>	<b>190308</b>	8	55	<b>7,41</b>	3
	<b>190310</b>	10	55	<b>7,41</b>	3
	<b>190311</b>	11	55	<b>7,41</b>	3
	<b>190312</b>	12	55	<b>7,41</b>	3
	<b>190313</b>	13	55	<b>7,41</b>	3
	<b>190314</b>	14	55	<b>7,41</b>	3
<b>Nuevo</b>	<b>190315</b>	15	55	<b>7,75</b>	3
<b>Nuevo</b>	<b>190316</b>	16	55	<b>7,75</b>	3
	<b>190317</b>	17	55	<b>7,75</b>	3

	Code	mm	L mm	P.V.P. unid. €	
<b>Nuevo</b>	<b>190318</b>	18	57	<b>7,80</b>	3
	<b>190319</b>	19	57	<b>7,95</b>	3
<b>Nuevo</b>	<b>190320</b>	20	57	<b>8,50</b>	3
<b>Nuevo</b>	<b>190321</b>	21	57	<b>8,50</b>	3
	<b>190322</b>	22	57	<b>8,77</b>	3
	<b>190324</b>	24	57	<b>9,40</b>	3
	<b>190327</b>	27	59	<b>11,79</b>	2
<b>Nuevo</b>	<b>190330</b>	30	59	<b>12,90</b>	2
	<b>190332</b>	32	59	<b>13,71</b>	2

## Vaso de 1/2" aislado con punta hexagonal

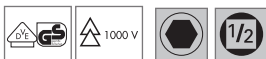

Code	mm	L mm	P.V.P. unid. €	
<b>190354</b>	4	75	<b>8,50</b>	2
<b>190355</b>	5	75	<b>9,73</b>	2
<b>190356</b>	6	75	<b>9,73</b>	2
<b>190358</b>	8	75	<b>9,73</b>	2
<b>190360</b>	10	75	<b>10,00</b>	2

## Alargadera y mango en T de 1/2" aislados

## Certificado VDE



190342



190340

Code	Tipo	L mm	P.V.P. unid. €	
<b>190342</b>	<b>ALARGADERA</b>	125	<b>34,00</b>	1
<b>190345</b>	<b>ALARGADERA</b>	250	<b>38,00</b>	1
<b>190340</b>	<b>MANGO EN T</b>	250	<b>46,00</b>	1

## Juego de vasos de 3/8" aislados

ACERO  
CR-V



Certificado VDE

Nuevo

### NORMA EN 60900

Herramientas aisladas utilizadas para trabajos en tensiones de hasta 1000V en Corriente Alterna ó 1500 V en Corriente Continua



#### COMPOSICION

8 Vasos aislados 3/8" 8, 10, 12, 13, 14, 17, 19 y 22	2 Alargaderas aisladas 167, 267 mm	1 Carraca aislada
4 Vasos aislados 3/8" punta hexagonal 4, 5, 6 y 8	1 Mango en "T" aislado 200 mm	

Code	Nº piezas	P.V.P. unid. €	
190304	16	280,00	1

## Juego de destorgolpe reforzado

ACERO  
CR-V



Dimensión caja: 330x160x60 mm

INCLUYE:



- Mango ergonómico en goma antideslizante
- Terminación cromado
- Tope superior metálico para golpeo



#### COMPOSICION

1 Destorgolpe 1/2" reforzado	1 Adaptador 3/8"M x 5/16"M	1 Adaptador 5/16"H x 1/2"H
18 Puntas impacto 5/16"H x 36 mm	4 6, 8, 10 12 mm	4 PH1, PH2, PH3, PH4
	4 4, 5, 6, 8 mm	6 T25, T27, T30 T40, T45, T50

Code	Nº piezas	P.V.P. unid. €	
192650	21	45,89	1

## Juego de destorgolpe más adaptadores

ACERO  
CR-V



• Terminación pavonado

INCLUYE:



#### COMPOSICION

- 1 Destorgolpe de 1/2"
- 1 Adaptador de 1/2"H x 5/16"H
- 1 Adaptador hexagonal 5/16"M x 3/8"M

Code	Nº piezas	P.V.P. unid. €	
192652	3	22,42	1

## Adaptador hexagonal para vasos



## Adaptador para puntas



Code	■	●	P.V.P. unid. €	
192648	3/8"	5/16"	1,50	6

Code	○	□	P.V.P. unid. €	
192649	5/16"	1/2"	1,34	6

## Juego de Vasos de 3/4"

ACERO  
CR-V



Dimensión caja: 540x180x80 mm

• Terminación cromado



### COMPOSICION

- Carraca mango desmontable
- Vasos 19, 21, 22, 24, 27, 30, 32, 33, 34, 36, 38, 41, 46, 50 mm
- Mango en "T" 400 mm
- Alargaderas 200, 400 mm

Code	Nº piezas	P.V.P. unid. €	
<b>192580</b>	18	<b>310,00</b>	1

## Llave de Carraca de 3/4"

DIN  
3122



ACERO  
CR-V



MANGO DESMONTABLE



- Con expulsor de vasos y reversor
- Mango metálico con acabado rugoso
- Presentación cromado

Code	L mm	P.V.P. unid. €	
<b>192555</b>	495	<b>83,30</b>	1

## Llave de Vaso de 3/4" Hexagonal

DIN  
3124

ACERO  
CR-V

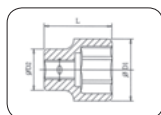

• Terminación cromado mate



Code	mm	L mm	D1 mm	D2 mm	P.V.P. unid. €	
<b>192519</b>	19	50	29	33	<b>8,59</b>	1
<b>192521</b>	21	50	31	33	<b>8,59</b>	1
<b>192522</b>	22	50	32	36	<b>8,59</b>	1
<b>192524</b>	24	51	34	36	<b>9,10</b>	1

Code	mm	L mm	D1 mm	D2 mm	P.V.P. unid. €	
<b>192527</b>	27	52	38	36	<b>9,46</b>	1
<b>192530</b>	30	54	42	38	<b>10,57</b>	1
<b>192532</b>	32	56	44	38	<b>10,87</b>	1
<b>192533</b>	33	56	46	38	<b>12,04</b>	1
<b>192534</b>	34	56	47	38	<b>12,04</b>	1
<b>192536</b>	36	58	50	42	<b>12,33</b>	1
<b>192538</b>	38	60	52	45	<b>13,72</b>	1
<b>192541</b>	41	64	56	45	<b>14,97</b>	1
<b>192546</b>	46	68	62	48	<b>17,72</b>	1
<b>192550</b>	50	72	68	48	<b>20,32</b>	1

## Alargadera

DIN  
3123

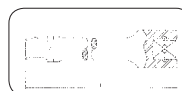

Code	L mm	P.V.P. unid. €	
<b>192565</b>	100	<b>12,99</b>	1
<b>192570</b>	200	<b>18,16</b>	1
<b>192575</b>	400	<b>29,50</b>	1

## Mango en T

DIN  
3122

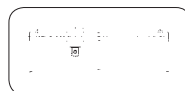

Code	L mm	P.V.P. unid. €	
<b>192560</b>	450	<b>28,03</b>	1

## Adaptador

DIN  
3123



Code	Hembra	Macho	P.V.P. unid. €	
<b>192630</b>	3/4"	1/2"	<b>12,00</b>	1
<b>192632</b>	3/4"	1"	<b>16,66</b>	1

## Juego de Vasos bihexagonales de 1"

ACERO  
CR-V



Dimensión caja: 650x210x110 mm

• Terminación cromado



### COMPOSICION

- 1 Carraca mango desmontable
- 1 Mango en "T" 560 mm
- 2 Alargaderas 200, 400 mm
- 10 Vasos bihexagonales 36, 41, 46, 50, 55, 60, 65, 70, 75, 80 mm

Code	Nº piezas	P.V.P. unid. €	
<b>194820</b>	14	<b>742,76</b>	1

## Llave de Carraca de 1"

DIN  
3122



ACERO  
CR-V



### MANGO DESMONTABLE



Code	L mm	P.V.P. unid. €	
<b>194885</b>	660	<b>172,60</b>	1

## Llave de Vaso de 1" bihexagonal

DIN  
3124

ACERO  
CR-V

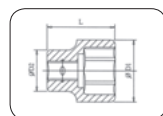

• Terminación cromado brillante



Code	Ø mm	L mm	D1 mm	D2 mm	P.V.P. unid. €	
<b>194836</b>	36	65	52	45	<b>20,25</b>	1
<b>194841</b>	41	70	57	45	<b>24,55</b>	1
<b>194846</b>	46	75	65	50	<b>29,06</b>	1
<b>194850</b>	50	75	70	55	<b>33,33</b>	1
<b>194855</b>	55	80	76	57	<b>38,06</b>	1
<b>194860</b>	60	85	85	57	<b>46,31</b>	1
<b>194865</b>	65	87	87	57	<b>55,34</b>	1
<b>194870</b>	70	94	94	68	<b>62,35</b>	1
<b>194875</b>	75	98	100	68	<b>69,84</b>	1
<b>194880</b>	80	102	105	68	<b>79,98</b>	1

## Alargadera

DIN  
3123

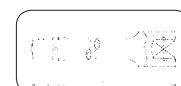

Code	L mm	P.V.P. unid. €	
<b>194886</b>	200	<b>44,34</b>	1
<b>194887</b>	400	<b>45,26</b>	1

## Mango en T

DIN  
3122

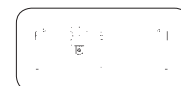

Code	L mm	P.V.P. unid. €	
<b>194888</b>	560	<b>56,98</b>	1

## Adaptador

DIN  
3123



Code	Hembra	Macho	P.V.P. unid. €	
<b>194890</b>	1"	3/4"	<b>26,61</b>	1



## Llave de vaso de impacto

ACERO  
CR-MO

6 Concentricidad

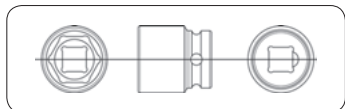

5 Perfil especial

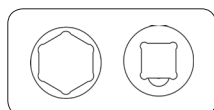

- 1 Fabricados en Acero aleado con alto grado de Cromo
- 2 Tratado térmicamente
- 3 Fabricados según normas DIN
- 4 Terminación pavonado
- 5 Ranuras de desahogo para reducir el stress interior y evitar dañar las aristas de las tuercas
- 6 Hexágono y cuadrado concéntricos para reducir al máximo las vibraciones
- 7 Diseño compacto para utilizar los vasos en lugares de difícil acceso

7 Forma compacta

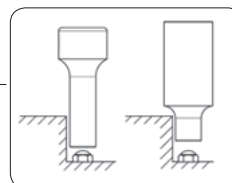

## Llave de Vaso de impacto de 1/2"

DIN  
3129

ACERO  
CR-MO

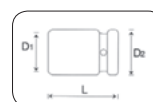

Code	mm	L mm	D1 mm	D2 mm	P.V.P. unid. €	
198208	8	38	15	25	5,11	1
198209	9	38	16	25	5,11	1
198210	10	38	17,5	25	5,11	1
198211	11	38	18,5	25	5,11	1
198212	12	38	20	25	5,11	1
198213	13	38	21,2	25	5,11	1
198214	14	38	22,5	25	5,11	1
198215	15	38	23,7	30	5,70	1
198216	16	38	25	30	5,70	1

Code	mm	L mm	D1 mm	D2 mm	P.V.P. unid. €	
198217	17	38	26,2	30	5,70	1
198218	18	38	27,5	30	5,87	1
198219	19	38	28,7	30	5,87	1
198220	20	38	30	30	6,25	1
198221	21	39	31,2	30	6,51	1
198222	22	39	32,5	30	6,74	1
198223	23	41	33,7	30	6,74	1
198224	24	41	35	30	7,33	1
Nuevo 198225	25	44	35	30	7,50	1
Nuevo 198226	26	45	37,5	30	7,50	1
198227	27	44	38,7	30	7,59	1
Nuevo 198228	28	50	40	30	8,50	1
Nuevo 198229	29	50	40	30	9,00	1
198230	30	50	42,5	30	9,31	1
198232	32	50	45	30	9,99	1

## Juego de Vasos de impacto de 1/2", regleta de plástico



### COMPOSICION

10, 11, 13, 14, 15, 16, 17, 19, 21, 22 mm

Code	Nº piezas	P.V.P. unid. €	
198233	10	56,65	1

## Llave de Vasos de impacto de 1/2", serie larga

DIN  
3129

ACERO  
CR-MO



SERIE LARGA



Code	mm	L mm	D1 mm	D2 mm	P.V.P. unid. €	
<b>Nuevo</b> 198239	8	80	15	25	<b>8,83</b>	1
198240	10	80	17	25	<b>8,83</b>	1
198249	11	80	18,5	25	<b>8,83</b>	1
198250	12	80	20	25	<b>8,83</b>	1
198241	13	80	21	25	<b>8,83</b>	1
198251	14	80	22,5	30	<b>9,00</b>	1
198252	15	80	23,5	30	<b>9,00</b>	1
198253	16	80	25	30	<b>9,00</b>	1
198242	17	80	26,2	30	<b>9,48</b>	1

Code	mm	L mm	D1 mm	D2 mm	P.V.P. unid. €	
198254	18	80	26,5	30	<b>9,48</b>	1
198243	19	80	28,5	30	<b>9,48</b>	1
198255	20	80	30	30	<b>10,00</b>	1
198256	21	80	31	30	<b>10,00</b>	1
198244	22	80	32	30	<b>10,54</b>	1
<b>Nuevo</b> 198257	23	80	34	30	<b>11,00</b>	1
198245	24	80	34	30	<b>11,45</b>	1
<b>Nuevo</b> 198266	25	80	34	30	<b>12,00</b>	1
<b>Nuevo</b> 198267	26	80	36	30	<b>12,50</b>	1
198246	27	80	39	30	<b>13,10</b>	1
<b>Nuevo</b> 198268	28	80	40	30	<b>14,00</b>	1
<b>Nuevo</b> 198269	29	80	40	30	<b>14,50</b>	1
198247	30	80	42,5	30	<b>14,96</b>	1
198248	32	80	51	30	<b>18,14</b>	1

## Juego de vasos de impacto de 1/2", serie larga



### COMPOSICION

10, 11, 13, 14, 15, 16, 17, 19, 21, 22 mm

Code	Nº piezas	P.V.P. unid. €	
198258	10	<b>89,00</b>	1

## Llave de Vaso de impacto de 1/2", Torx hembra tipo E

DIN  
3129

ACERO  
CR-MO



TORX HEMBRA



Code		L mm	P.V.P. unid. €	
198200	E10	38	<b>5,89</b>	10
198201	E12	38	<b>5,89</b>	10
198202	E14	38	<b>5,89</b>	10
198203	E16	38	<b>5,89</b>	10
198204	E18	38	<b>5,89</b>	10
198205	E20	38	<b>6,07</b>	10
198206	E24	38	<b>6,80</b>	10

## Llave de Vaso de impacto de 1/2" para ruedas

ACERO  
CR-MO



• Recubrimiento de plástico exterior para no dañar la llanta



Code	mm	L mm	Ø mm	P.V.P. unid. €	
<b>198902</b>	17	85	30	<b>8,64</b>	1
<b>198904</b>	19	85	30	<b>8,64</b>	1
<b>198906</b>	21	85	30	<b>8,64</b>	1

## Juego de Vasos de impacto de 1/2" para ruedas

ACERO  
CR-MO



Dimensión caja: 143x121x49 mm



COMPOSICION 17, 19, 21 mm

Code	Nº piezas	P.V.P. unid. €	
<b>198900</b>	3	<b>27,92</b>	1

## Alargadera de impacto

DIN  
3121

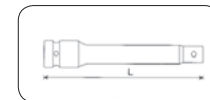

Code	L mm	P.V.P. unid. €	
<b>198260</b>	75	<b>8,24</b>	1
<b>198262</b>	125	<b>10,04</b>	1
<b>198265</b>	250	<b>14,34</b>	1

## Junta universal de impacto

DIN  
3121

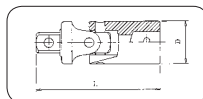

Code	L mm	P.V.P. unid. €	
<b>198270</b>	67	<b>15,00</b>	1

## Adaptador de impacto

DIN  
3121



Code	Hembra	Macho	L mm	P.V.P. unid. €	
<b>198275</b>	1/2"	3/4"	49	<b>8,00</b>	1

## Llave de Vaso de impacto de 1/2" punta Allen

DIN  
3129

ACERO  
CR-MO

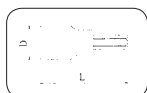

Code	mm	L mm	D mm	P.V.P. unid. €	
<b>198285</b>	5	78	25	<b>11,34</b>	1
<b>198286</b>	6	78	25	<b>11,42</b>	1
<b>198288</b>	8	78	25	<b>11,52</b>	1
<b>198290</b>	10	78	25	<b>11,89</b>	1
<b>198292</b>	12	78	25	<b>11,99</b>	1
<b>198294</b>	14	78	30	<b>12,27</b>	1
<b>198297</b>	17	78	30	<b>12,66</b>	1
<b>198299</b>	19	78	30	<b>13,49</b>	1

## Juego de vasos de impacto de 1/2" punta Allen



### COMPOSICION

5, 6, 8, 10, 12, 14, 17, 19 mm

Code	Nº piezas	P.V.P. unid. €	
<b>198300</b>	8	<b>90,00</b>	1

## Llave de Vaso de impacto de 1/2" punta Torx

DIN  
3129

ACERO  
CR-MO

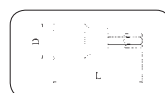

Code		L mm	D mm	P.V.P. unid. €	
<b>198302</b>	T25	78	25	<b>11,52</b>	1
<b>198304</b>	T27	78	25	<b>11,52</b>	1
<b>198306</b>	T30	78	25	<b>11,52</b>	1
<b>198308</b>	T40	78	25	<b>11,63</b>	1
<b>198310</b>	T45	78	25	<b>11,63</b>	1
<b>198312</b>	T50	78	25	<b>11,63</b>	1
<b>198314</b>	T55	78	25	<b>12,04</b>	1
<b>198316</b>	T60	78	25	<b>12,04</b>	1

## Juego de vasos de impacto de 1/2" punta Torx



### COMPOSICION

T25, T27, T30, T40, T45, T50, T55, T60

Code	Nº piezas	P.V.P. unid. €	
<b>198301</b>	8	<b>93,53</b>	1

## Llave de vaso de impacto de 1/2" punta XZN

DIN  
3129

ACERO  
CR-MO



Code		L mm	Ø mm	P.V.P. unid. €	
<b>198180</b>	M6	78	25	<b>10,66</b>	1
<b>198181</b>	M8	78	25	<b>10,95</b>	1
<b>198182</b>	M10	78	25	<b>11,50</b>	1
<b>198183</b>	M12	78	25	<b>11,50</b>	1
<b>198184</b>	M14	78	25	<b>11,80</b>	1
<b>198185</b>	M16	78	25	<b>12,08</b>	1

## Llave de Vaso de impacto de 3/4"

DIN  
3129

ACERO  
CR-MO



SERIE NORMAL

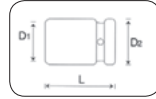

DIN  
3124

ACERO  
CR-MO



SERIE LARGA

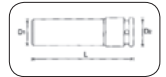

Code	mm	L mm	D1 mm	D2 mm	P.V.P. unid. €	
198317	17	51	30	44	11,54	1
198319	19	51	32,5	44	11,54	1
198321	21	51	35	44	11,75	1
198322	22	51	36	44	11,96	1
198324	24	51	38,5	44	11,96	1
198327	27	53	42,5	44	11,96	1
198330	30	53	46	44	12,17	1
198332	32	57	48,5	44	12,69	1
198334	34	57	51	44	14,80	1
198336	36	57	53,5	44	15,18	1
198338	38	57	56	44	16,01	1
198341	41	58	60	44	18,23	1
198346	46	62	66	44	21,88	1
198350	50	68	71	44	26,54	1
198355	55	72	77,5	54	40,92	1
198360	60	72	83,5	54	40,92	1

Code	mm	L mm	D1 mm	D2 mm	P.V.P. unid. €	
198370	17	100	30	44	19,04	1
198371	19	100	33	44	19,04	1
198372	21	100	35	44	19,25	1
198373	22	100	36	44	19,25	1
198374	24	100	38	44	19,46	1
198375	27	100	42	44	19,46	1
198376	30	100	46	44	19,85	1
198377	32	100	48	44	20,25	1
198378	34	100	51	44	22,69	1
198379	36	100	53	44	22,90	1
198380	41	100	59	44	26,95	1
Nuevo 198381	46	100	66	44	30,30	1
Nuevo 198383	50	100	71	44	36,00	1
Nuevo 198385	55	100	77,5	44	53,50	1
Nuevo 198387	60	100	83,5	44	58,00	1

## Alargadera de impacto

DIN  
3121

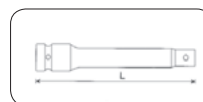

Code	L mm	P.V.P. unid. €	
198382	175	25,93	1
198384	250	31,81	1
198386	325	36,63	1

## Junta universal de impacto

DIN  
3121

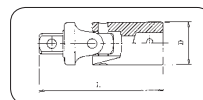

Code	L mm	P.V.P. unid. €	
198390	110	50,56	1

## Adaptador de impacto

DIN  
3121



Code	Hembra	Macho	L mm	P.V.P. unid. €	
198392	3/4"	1/2"	56	16,62	1
198395	3/4"	1"	68	17,82	1

## Llave de Vaso de impacto de 1"

DIN  
3129

ACERO  
CR-MO



SERIE NORMAL

DIN  
3129

ACERO  
CR-MO

SERIE LARGA

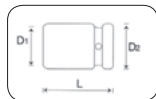

Code	mm	L mm	D1 mm	D2 mm	P.V.P. unid. €		Code	mm	L mm	D1 mm	D2 mm	P.V.P. unid. €	
198424	24	57	41	54	20,34	1	198475	24	108	41	54	32,01	1
198427	27	57	45	54	21,16	1	198476	27	108	45	54	33,31	1
198430	30	60	49	54	21,75	1	198477	30	108	48	54	33,31	1
198432	32	60	51	54	21,75	1	198478	32	108	51	54	33,31	1
198434	34	64	54	54	21,75	1	198479	34	108	54	54	33,31	1
198436	36	65	57	54	22,16	1	198480	36	108	56	54	39,07	1
198438	38	66	59	54	23,36	1	198481	38	108	59	54	39,07	1
198441	41	68	63	54	25,81	1	198482	41	108	62	54	43,53	1
198446	46	73	69	54	31,90	1	198483	46	108	68	54	47,23	1
198450	50	70	74	54	36,74	1	Nuevo 198484	50	108	74	54	52,50	1
198455	55	75	81	54	43,43	1	Nuevo 198485	55	108	80	54	77,50	1
198460	60	80	86	54	53,77	1	Nuevo 198486	60	108	86,5	54	85,80	1
198465	65	92	92,5	54	62,35	1	Nuevo 198487	65	108	92,5	54	98,00	1
198470	70	96	99	54	71,37	1	Nuevo 198488	70	108	99	54	118,00	1

## Alargadera de impacto

DIN  
3121

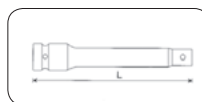

Code	L mm	P.V.P. unid. €	
198490	175	40,24	1
198492	325	55,00	1

## Junta universal de impacto

DIN  
3121

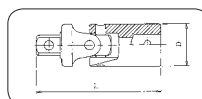

Code	L mm	P.V.P. unid. €	
198495	132	65,36	1

## Adaptador de impacto

DIN  
3121



Code	Hembra	Macho	L mm	P.V.P. unid. €	
198497	1"	3/4"	65	26,24	1

## Llave de Vaso de impacto de 1 - 1/2"

DIN  
3129

ACERO  
CR-MO



Code	mm	L mm	Ø mm	P.V.P. unid. €	
<b>198946</b>	46	84	86	<b>127,22</b>	1
<b>198950</b>	50	87	86	<b>127,22</b>	1
<b>198955</b>	55	90	86	<b>135,00</b>	1
<b>198960</b>	60	92	94	<b>149,00</b>	1
<b>198965</b>	65	95	97	<b>154,00</b>	1
<b>198970</b>	70	100	105	<b>185,00</b>	1

Code	mm	L mm	Ø mm	P.V.P. unid. €	
<b>198975</b>	75	103	110	<b>187,00</b>	1
<b>198980</b>	80	110	116	<b>197,00</b>	1
<b>198981</b>	85	118	125	<b>205,00</b>	1
<b>198982</b>	90	118	130	<b>229,00</b>	1
<b>198983</b>	95	118	137	<b>235,00</b>	1
<b>198984</b>	100	125	144	<b>279,00</b>	1

## Anillas de impacto de seguridad

DIN  
3129

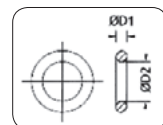

Code		Utilización Accesorios Vasos	D1 mm	D2 mm	P.V.P. unid. €	
<b>198276</b>	1/2"	✓ ≤ 14	4	19	<b>2,02</b>	5
<b>198277</b>	1/2"	✓ ≥ 14	4	24	<b>2,02</b>	5
<b>198396</b>	3/4"	✓ ≤ 50	5	36	<b>2,02</b>	5
<b>198397</b>	3/4"	✓ ≥ 55	5	46	<b>2,02</b>	5
<b>198498</b>	1"	✓ ≤ 70	7	45	<b>2,02</b>	5

## Pasadores de impacto de seguridad

DIN  
3129

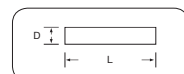

Code		Utilización Accesorios Vasos	L mm	D mm	P.V.P. unid. €	
<b>198278</b>	1/2"	✓ ≤ 14	20	3	<b>1,39</b>	5
<b>198279</b>	1/2"	✓ ≥ 14	25	3	<b>1,47</b>	5
<b>198398</b>	3/4"	✓ ≤ 50	35	4	<b>1,52</b>	5
<b>198399</b>	3/4"	✓ ≥ 55	45	4	<b>1,63</b>	5
<b>198499</b>	1"	✓ ≤ 70	45	6	<b>1,77</b>	5



## 08 Percusión



Martillo de bola 167



Maceta 169



Martillo de construcción 170



Maza 171



Hacha 172



Piqueta y alcotana 173



Martillo de bocas de nylon 174



Maceta de cobre 174



Maza antirrebote 175



Botador y granete 176



Cinzel y puntero 178



Cortafrió y buril 180



**Martillo de bola, mango de grafito**

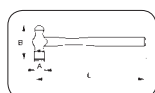

- Cabeza en Acero al Carbono forjado
- Superficie de trabajo templada (alta dureza)
- Fijación del mango mediante resina
- Agujero en el mango para colgar

**COMPARATIVA GRAFITO-FIBRA DE VIDRIO**

- **MAS LIGERO.** Peso aproximado 20% menor
- **MAS RESISTENTE.** Resistencia a los impactos 30% mayor
- **ANTI-VIBRACION.** Absorbe mucho mejor la vibración del golpe y la transmite en menor grado al brazo. Más ergonómico y menor fatiga.

Code	gr	A mm	L mm	P.V.P. unid. €	
<b>196652</b>	455	30	355	<b>15,42</b>	6
<b>196654</b>	560	32	380	<b>16,83</b>	6
<b>196657</b>	680	34	405	<b>18,37</b>	6
<b>196663</b>	910	38	405	<b>21,56</b>	6
<b>196664</b>	1360	40	405	<b>32,35</b>	6

**MANGOS DE RECAMBIO**

<b>196653</b>	para 196652, 196654	<b>6,00</b>	6
<b>196658</b>	para 196657, 196663, 196664	<b>7,00</b>	6

**Martillo de bola, mango de fibra de vidrio**

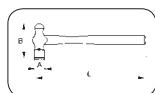

**Nuevo**

- Cabeza en Acero al Carbono forjado
- Superficie de trabajo templada (alta dureza)
- Fijación del mango mediante resina
- Mango de fibra de vidrio en forma ergonómica

Code	gr	A mm	L mm	P.V.P. unid. €	
<b>186318</b>	360	28	345	<b>9,50</b>	6
<b>186320</b>	455	30	345	<b>11,50</b>	6
<b>186324</b>	680	34	345	<b>13,50</b>	6
<b>186326</b>	910	38	345	<b>16,00</b>	6
<b>186327</b>	1360	38	345	<b>18,80</b>	6

**MANGOS DE RECAMBIO**

<b>186319</b>	para 186318	<b>4,50</b>	6
<b>186321</b>	para 186320, 186324, 186326	<b>5,10</b>	6
<b>186329</b>	para 186327	<b>6,00</b>	6

**Martillo de bola, mango de Hickory**

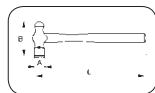

- Cabeza en Acero al Carbono forjado
- Superficie de trabajo templada (alta dureza)
- Fijación del mango por cuña metálica y resina
- Mango de Hickory

Code	gr	A mm	L mm	P.V.P. unid. €	
<b>196548</b>	360	28	345	<b>10,00</b>	6
<b>196550</b>	455	30	355	<b>12,00</b>	6
<b>196554</b>	520	32	380	<b>12,70</b>	6
<b>196555</b>	680	34	405	<b>14,50</b>	6
<b>196560</b>	910	38	405	<b>17,50</b>	6
<b>196562</b>	1360	40	405	<b>22,00</b>	6

**MANGOS DE RECAMBIO**

<b>196551</b>	para 196548, 196550, 196554	<b>5,50</b>	6
<b>196556</b>	para 196555, 196560	<b>6,00</b>	6
<b>196563</b>	para 196562	<b>6,40</b>	6

## Martillo de peña, mango de grafito



- Cabeza en Acero al Carbono forjado
- Superficie de trabajo templada (alta dureza)
- Fijación del mango por resina
- Mango de grafito en forma ergonómica

## Martillo de peña, mango fibra de vidrio



- Cabeza en Acero al Carbono forjado
- Superficie de trabajo templada (alta dureza)
- Fijación del mango por resina
- Mango de fibra de vidrio en forma ergonómica

## Martillo de peña, mango de Hickory



- Cabeza en Acero al Carbono forjado
- Superficie de trabajo templada (alta dureza)
- Fijación de mango por resina y cuña metálica
- Mango de Hickory

## Martillo de ajustador, mango fibra de vidrio



- Cabeza en Acero al Carbono forjado
- Superficie de trabajo templada (alta dureza)
- Fijación de mango por resina
- Mango de fibra de vidrio en forma ergonómica

Code	gr	A mm	L mm	P.V.P. unid. €	
<b>196612</b>	80	16	310	<b>12,58</b>	6
<b>196617</b>	135	20	310	<b>13,46</b>	6
<b>196622</b>	180	22	310	<b>14,43</b>	6
<b>196628</b>	320	25	310	<b>15,51</b>	6
<b>196632</b>	420	30	310	<b>15,95</b>	6

### MANGOS DE RECAMBIO

<b>196613</b>	para 196612, 196617	<b>7,00</b>	6
<b>196629</b>	para 196622, 196628, 196632	<b>7,50</b>	6

**Nuevo**

Code	gr	A mm	L mm	P.V.P. unid. €	
<b>186308</b>	135	20	280	<b>8,20</b>	6
<b>186310</b>	180	22	280	<b>9,10</b>	6
<b>186312</b>	320	25	310	<b>10,10</b>	6
<b>186314</b>	420	30	340	<b>11,20</b>	6

### MANGOS DE RECAMBIO

<b>186309</b>	para 186308, 186310	<b>3,50</b>	6
<b>186313</b>	para 186312	<b>4,10</b>	6
<b>186315</b>	para 186314	<b>4,30</b>	6

Code	gr	A mm	L mm	P.V.P. unid. €	
<b>196510</b>	100	18	280	<b>6,89</b>	6
<b>196515</b>	135	20	280	<b>7,12</b>	6
<b>196520</b>	180	22	280	<b>7,75</b>	6
<b>196523</b>	320	25	280	<b>8,03</b>	6
<b>196524</b>	420	30	280	<b>9,57</b>	6

### MANGOS DE RECAMBIO

<b>196511</b>	para 196510	<b>3,17</b>	6
<b>196516</b>	para 196515, 196520	<b>3,25</b>	6
<b>196522</b>	para 196523	<b>3,39</b>	6
<b>196527</b>	para 196524	<b>3,71</b>	6

Code	gr	A mm	L mm	P.V.P. unid. €	
<b>186328</b>	300	22	310	<b>9,90</b>	6
<b>186330</b>	500	26	340	<b>10,90</b>	4

### MANGOS DE RECAMBIO

<b>186313</b>	para 186328	<b>4,10</b>	6
<b>186315</b>	para 186330	<b>4,30</b>	6

**Maceta de albañil, mango de grafito**



- Cabeza fabricada en Acero al Carbono forjado
- Superficie de trabajo templada (alta dureza)
- Mango cónico de grafito

Code	kg	L mm	P.V.P. unid. €	
<b>196605</b>	1	290	<b>18,50</b>	4
<b>196608</b>	1,25	290	<b>22,00</b>	4

**MANGOS DE RECAMBIO**

<b>196606</b>	para 196605, 196608	<b>9,00</b>	6
---------------	---------------------	-------------	---

**Nuevo**

**Maceta de albañil, mango de fibra de vidrio**



- Cabeza fabricada en Acero al Carbono forjado
- Superficie de trabajo templada (alta dureza)
- Fijación de mango por resina
- Mango de fibra de vidrio en forma ergonómica

Code	kg	L mm	P.V.P. unid. €	
<b>196600</b>	1	280	<b>12,80</b>	6
<b>196602</b>	1,5	280	<b>14,50</b>	6

**MANGOS DE RECAMBIO**

<b>196601</b>	para 196600, 196602	<b>4,50</b>	6
---------------	---------------------	-------------	---

**Maceta de albañil, mango de Hickory**



**Nuevo**

- Cabeza fabricada en Acero al Carbono forjado
- Superficie de trabajo templada (alta dureza)
- Fijación de mango por resina y cuña metálica

Code	kg	L mm	P.V.P. unid. €	
<b>196500</b>	1	260	<b>10,50</b>	6
<b>196502</b>	1,4	280	<b>12,50</b>	4

**MANGOS DE RECAMBIO**

<b>196501</b>	para 196500	<b>2,70</b>	6
<b>196518</b>	para 196502	<b>3,10</b>	6

**Maceta cuadrada, mango de fibra de vidrio**



**Nuevo**

- Fijación de mango mediante resina

Code	kg	L mm	P.V.P. unid. €	
<b>186200</b>	1	280	<b>12,00</b>	6
<b>186202</b>	1,5	280	<b>13,50</b>	6
<b>186204</b>	2	280	<b>14,90</b>	6

**MANGOS DE RECAMBIO**

<b>196601</b>	para 186200, 186202, 186204,	<b>4,50</b>	6
---------------	------------------------------	-------------	---

**Maceta cuadrada, mango de Hickory**



**Nuevo**

- Fijación de mango mediante cuña metálica y resina

Code	kg	L mm	P.V.P. unid. €	
<b>186300</b>	1	260	<b>10,75</b>	6
<b>186302</b>	1,5	280	<b>12,50</b>	6
<b>186304</b>	2	280	<b>13,90</b>	6

**MANGOS DE RECAMBIO**

<b>196501</b>	para 186300,	<b>2,70</b>	6
<b>196518</b>	para 186302, 186304	<b>3,10</b>	6

## Martillo de uña curva, mango de fibra de vidrio



## Martillo de uña curva, mango de madera



## Martillo de uña curva americano, mango de fibra de vidrio



## Martillo de encofrador, mango de fibra de vidrio



## Martillo de encofrador, mango de madera



**Nuevo**

- Cabeza fabricada en Acero al Carbono forjado
- Superficie de trabajo templada (alta dureza)
- Mango cónico de grafito

Code	gr	L mm	P.V.P. unid. €	
<b>196665</b>	400	330	<b>11,79</b>	6
<b>196670</b>	600	330	<b>13,14</b>	6

### MANGOS DE RECAMBIO

<b>196666</b>	para 196665,196670	<b>4,00</b>	6
---------------	--------------------	-------------	---

Code	gr	L mm	P.V.P. unid. €	
<b>196565</b>	400	330	<b>9,72</b>	6
<b>196570</b>	600	330	<b>10,99</b>	6
<b>196575</b>	800	390	<b>12,47</b>	6

### MANGOS DE RECAMBIO

<b>196566</b>	para 196565,196570	<b>2,50</b>	6
---------------	--------------------	-------------	---

<b>196576</b>	para 196575	<b>3,16</b>	6
---------------	-------------	-------------	---

**Nuevo**

- Fijación de mango mediante resina

Code	gr	L mm	P.V.P. unid. €	
<b>186340</b>	450	345	<b>9,50</b>	6
<b>186342</b>	560	345	<b>10,90</b>	6

### MANGOS DE RECAMBIO

<b>186321</b>	para 186340,186342	<b>5,10</b>	6
---------------	--------------------	-------------	---

**Nuevo**

- Cabeza con imán. Fijación cónica

Code	gr	L mm	P.V.P. unid. €	
<b>196690</b>	700	500	<b>20,00</b>	6

### MANGOS DE RECAMBIO

<b>196691</b>	para 196690	<b>5,50</b>	6
---------------	-------------	-------------	---

Code	gr	L mm	P.V.P. unid. €	
<b>196580</b>	500	500	<b>12,50</b>	6
<b>196590</b>	700	500	<b>13,30</b>	6

### MANGOS DE RECAMBIO

<b>196581</b>	para 196580, 196590	<b>3,00</b>	6
---------------	---------------------	-------------	---

**Nuevo**

**Maza, mango de fibra de vidrio**



- Cabeza fabricada en Acero al Carbono forjado
- Superficie de trabajo templada (alta dureza)

Code	kg	L mm	P.V.P. unid. €	
<b>196625</b>	3	900	<b>39,45</b>	4
<b>196627</b>	4	900	<b>43,79</b>	2
<b>196630</b>	5	900	<b>48,19</b>	2

**MANGOS DE RECAMBIO**

<b>196631</b>	196625,196627,196630	<b>14,21</b>	6
---------------	----------------------	--------------	---

**Maza, mango de madera**



- Cabeza fabricada en Acero al Carbono forjado
- Superficie de trabajo templada (alta dureza)

Code	kg	L mm	P.V.P. unid. €	
<b>196525</b>	3	900	<b>26,61</b>	4
<b>196530</b>	5	900	<b>34,85</b>	2

**MANGOS DE RECAMBIO**

<b>196531</b>	para 196525, 196530	<b>8,18</b>	6
---------------	---------------------	-------------	---

**Nuevo**

**Maza cuña, mango de fibra de vidrio**



- Cabeza con filo de corte pulido reafilable
- Fijación por ojo cónico

Code	Peso kg	L mm	P.V.P. unid. €	
<b>196633</b>	3,5	900	<b>52,00</b>	4

**MANGOS DE RECAMBIO**

<b>196631</b>	para 196633	<b>14,21</b>	6
---------------	-------------	--------------	---

**Maza de cantero, mango de madera**



- Fijación cónica

Code	kg	L mm	P.V.P. unid. €	
<b>196503</b>	1	250	<b>12,70</b>	6

**MANGOS DE RECAMBIO**

<b>196504</b>	para 196503	<b>2,50</b>	6
---------------	-------------	-------------	---

**Nuevo**

**Cuña metálica para madera**

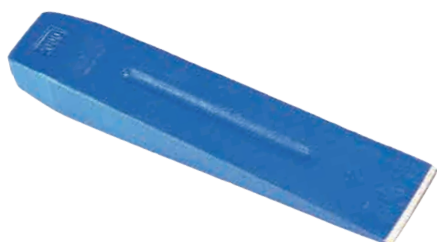

250x50x36 mm  
2 kg

- Cuerpo forjado de una sola pieza
- Filo de corte pulido
- Diseñada para una buena penetración en la madera

Code	P.V.P. unid. €	
<b>198680</b>	<b>14,00</b>	6

## Pico



Mangos acoplables 198676 / 198776

- Acero al carbono. Cuerpo forjado
- Punta pulidas. Ojo cónico

	Code	Peso kg	L mm	P.V.P. unid. €	
<b>Nuevo</b>	<b>198668</b>	2	550	<b>15,50</b>	6
	<b>198670</b>	2,5	580	<b>17,00</b>	6
	<b>198675</b>	3	580	<b>19,50</b>	6

Se suministra sin mango

## Mango para picos



- Mango ergonómico
- Para fijación cónica

	Code	Tipo	Ø x L mm	P.V.P. unid. €	
<b>Nuevo</b>	<b>198676</b>	Madera	38 x 900	<b>8,60</b>	6
	<b>198776</b>	Fibra	38 x 900	<b>17,00</b>	6

## Hacha, mango de fibra de vidrio



**Nuevo**

- Filo de corte pulido reafilable
- Fijación por ojo cónico
- Protección plástica del filo

	Code	Peso gr	L mm	P.V.P. unid. €	
	<b>186348</b>	400	280	<b>12,50</b>	6
	<b>186350</b>	600	380	<b>14,20</b>	6
	<b>186352</b>	800	480	<b>16,80</b>	6
	<b>186354</b>	1000	680	<b>20,50</b>	4
	<b>186356</b>	1250	900	<b>31,20</b>	4

## Hacha, mango de Hickory



**Nuevo**

- Cabeza con filo de corte pulido reafilable
- Fijación por ojo cónico

	Code	Peso gr	L mm	P.V.P. unid. €	
	<b>198620</b>	500	450	<b>18,50</b>	6
	<b>198625</b>	700	450	<b>20,50</b>	6
	<b>198630</b>	1000	680	<b>28,00</b>	4
	<b>198632</b>	1200	680	<b>30,50</b>	4

## Piqueta de soldador



ESPECIAL SOLDADURA

- Puntas de pico y hacha vertical
- Mango tubular metálico
- Empuñadura de goma ergonómica

	Code	Peso gr	L mm	P.V.P. unid. €	
	<b>198748</b>	400	300	<b>8,60</b>	6

**Piqueta de albañil, mango de fibra de vidrio**



**Nuevo**

Code	Peso gr	L mm	P.V.P. unid. €	
<b>196695</b>	700	330	<b>19,00</b>	6
<b>MANGOS DE RECAMBIO</b>				
<b>196666</b>	para 196695		<b>4,00</b>	6

**Piqueta de albañil, mango de madera**



Code	Peso gr	L mm	P.V.P. unid. €	
<b>196595</b>	700	330	<b>15,00</b>	6
<b>MANGOS DE RECAMBIO</b>				
<b>196566</b>	para 196595		<b>2,50</b>	6

**Alcotana Pala-Acha, mango de fibra de vidrio**



**Nuevo**

Code	Peso gr	L mm	P.V.P. unid. €	
<b>198750</b>	550	330	<b>16,00</b>	6
<b>198755</b>	650	330	<b>17,00</b>	6
<b>MANGOS DE RECAMBIO</b>				
<b>196666</b>	para 198750, 198755		<b>4,00</b>	6

**Alcotana Pala-Acha, mango de madera**



Code	Peso gr	L mm	P.V.P. unid. €	
<b>198650</b>	550	330	<b>13,00</b>	6
<b>198655</b>	650	330	<b>14,50</b>	6
<b>MANGOS DE RECAMBIO</b>				
<b>196566</b>	para 198650, 198655		<b>2,50</b>	6

**Alcotana Pala-Pico, mango de fibra de vidrio**



**Nuevo**

Code	Peso gr	L mm	P.V.P. unid. €	
<b>198758</b>	400	330	<b>15,00</b>	6
<b>198760</b>	650	330	<b>16,00</b>	6
<b>MANGOS DE RECAMBIO</b>				
<b>196666</b>	para 198758, 198760		<b>4,00</b>	6

**Alcotana Pala-Pico, mango de madera**



Code	Peso gr	L mm	P.V.P. unid. €	
<b>198658</b>	400	330	<b>12,50</b>	6
<b>198660</b>	650	330	<b>13,50</b>	6
<b>MANGOS DE RECAMBIO</b>				
<b>196566</b>	para 198658, 198660		<b>2,50</b>	6

## Martillo de bocas de nylon, mango metálico

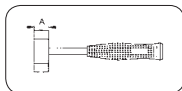

- Cuerpo fabricado en hierro pavonado
- Bocas de nylon tratadas insertadas a presión en el cuerpo metálico
- Mango ergonómico antideslizante de goma

Code	A Ø mm	Peso gr	P.V.P. unid. €	
<b>196805</b>	28	300	<b>16,45</b>	6
<b>196810</b>	34	600	<b>20,58</b>	6
<b>196815</b>	44	1100	<b>28,33</b>	6

## Martillo de bocas de nylon, mango madera

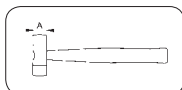

- Mango de madera unido al cuerpo del martillo mediante pasador metálico
- Mango de madera de alta calidad barnizado

Code	A Ø mm	Peso gr	P.V.P. unid. €	
<b>196705</b>	28	300	<b>11,40</b>	6
<b>196710</b>	34	550	<b>13,68</b>	6
<b>196715</b>	44	1050	<b>20,58</b>	6
<b>196720</b>	54	1100	<b>37,99</b>	6

## Bocas de nylon de recambio



### INSTRUCCIONES DE USO

Colocación de las bocas orientando en el cuerpo del martillo y golpeándolas para su inserción por impacto

Code	Ø mm	P.V.P. unid. €	
<b>196701</b>	28	<b>2,07</b>	10
<b>196702</b>	34	<b>2,49</b>	10
<b>196703</b>	44	<b>3,32</b>	10
<b>196704</b>	54	<b>6,00</b>	10

## Martillo de bocas de nylon antirrebote



- Cuerpo de hierro zincado
- Bocas de nylon tratadas insertadas a presión

Code	A Ø mm	Peso gr	P.V.P. unid. €	
<b>196725</b>	35	500	<b>25,00</b>	6
<b>196730</b>	50	1100	<b>36,00</b>	6
BOCAS DE RECAMBIO				
<b>196727</b>	para code 196725		<b>2,58</b>	10
<b>196732</b>	para code 196730		<b>3,79</b>	10

## Maceta de cobre antichispa



- Cabeza fabricada en cobre
- Mango de madera barnizado
- Fijación cónica

Code	Peso gr	Medida mm	P.V.P. unid. €	
<b>196760</b>	500	25x80x300	<b>53,00</b>	1
<b>196762</b>	1000	32x100x300	<b>79,00</b>	1
<b>196764</b>	1500	38x120x360	<b>105,00</b>	1
<b>196766</b>	2000	40x135x400	<b>129,00</b>	1
<b>196768</b>	4000	64x140x900	<b>255,00</b>	1

Empleo en siderurgia, minería, petroquímicas y lugares con riesgo de deflagración



**Maza de goma negra, mango fibra de vidrio**



Code	Peso gr	L mm	P.V.P. unid. €	
<b>196781</b>	455	340	<b>9,00</b>	6
<b>196784</b>	685	360	<b>9,50</b>	6

**Maza de goma blanca, mango fibra de vidrio**



Code	Peso gr	L mm	P.V.P. unid. €	
<b>196787</b>	455	340	<b>10,45</b>	6

**Maza de goma, mango de madera**



• Cabeza de caucho duro

Code	Peso gr	L mm	P.V.P. unid. €	
<b>196780</b>	455	310	<b>4,00</b>	6
<b>196782</b>	685	336	<b>5,50</b>	6
<b>196783</b>	910	360	<b>6,50</b>	6



• No mancha al golpear

Code	Peso gr	L mm	P.V.P. unid. €	
<b>196785</b>	455	310	<b>8,00</b>	6
<b>196786</b>	685	350	<b>9,00</b>	6

**Maza de goma combinada, mango de madera**



Code	Peso gr	L mm	P.V.P. unid. €	
<b>196788</b>	685	350	<b>10,00</b>	6

**Maza antirrebote de poliuretano**



• Fabricada en Poliuretano  
• Monobloc

Code	Peso gr	A Ø mm	L mm	P.V.P. unid. €	
<b>196789</b>	455	42	300	<b>13,15</b>	6
<b>196790</b>	690	50	325	<b>17,33</b>	6
<b>196792</b>	920	56,5	337	<b>19,48</b>	6

## Botador cilíndrico con protector

ACERO  
CR-V

Zona de golpeo  
templada a 40 HRC

Forma ergonómica.  
Zona de contacto con la mano  
de elastómero antideslizante

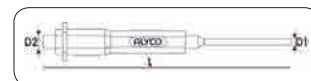

Zona de trabajo  
templada a 55 HRC

Capa para proteger  
la mano y cuerpo  
interior de plástico  
resistente

Presentación pavonado



Zonas de mayor esfuerzo  
rugosas para evitar  
deslizamientos durante  
el trabajo.

Code	D1 mm	D2 mm	L mm	P.V.P. unid. €	
<b>140062</b>	2	10	165	<b>6,00</b>	6
<b>140063</b>	3	10	175	<b>7,00</b>	6
<b>140064</b>	4	10	185	<b>7,80</b>	6
<b>140065</b>	5	10	200	<b>7,80</b>	6
<b>140066</b>	6	10	200	<b>7,80</b>	6
<b>140068</b>	8	10	200	<b>8,00</b>	6

Se suministra con colgador

## Granete con protector

ACERO  
CR-V

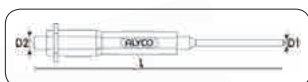

Code	D1 mm	D2 mm	L mm	P.V.P. unid. €	
<b>140054</b>	4	10	175	<b>5,69</b>	6
<b>140056</b>	6	10	175	<b>6,12</b>	6

Se suministra con colgador

## Juego de botadores con protector



### COMPOSICION

2, 3, 4, 5, 6, 8 mm

Code	Nº Piezas	P.V.P. unid. €	
<b>140070</b>	6	<b>46,53</b>	1

## Botador cilíndrico

ACERO  
CR-V

SERIE NORMAL

SERIE LARGA



• Cuerpo hexagonal

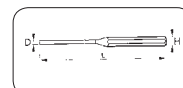

Code	D Ø mm	H mm	L mm	P.V.P. unid. €	
<b>140020</b>	2	10	150	<b>4,38</b>	10
<b>140021</b>	3	10	150	<b>4,38</b>	10
<b>140022</b>	4	10	150	<b>4,67</b>	10
<b>140023</b>	5	10	150	<b>4,67</b>	10
<b>140024</b>	6	10	150	<b>4,67</b>	10
<b>140025</b>	7	12	150	<b>5,03</b>	10
<b>140026</b>	8	12	150	<b>5,03</b>	10

Code	D Ø mm	H mm	L mm	P.V.P. unid. €	
<b>140034</b>	4	10	180	<b>5,52</b>	10
<b>140036</b>	6	10	180	<b>5,52</b>	10

**Botador cónico**

ACERO  
CR-V



• Cuerpo hexagonal

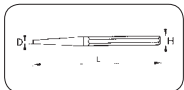

Code	D Ø mm	H mm	L mm	P.V.P. unid. €	
<b>140012</b>	2	10	120	<b>3,71</b>	10
<b>140013</b>	3	10	120	<b>3,71</b>	10
<b>140014</b>	4	10	120	<b>3,78</b>	10
<b>140015</b>	5	10	120	<b>4,06</b>	10
<b>140016</b>	6	10	120	<b>4,06</b>	10

**Granete**

ACERO  
CR-V

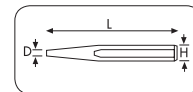

Code	D Ø mm	H mm	L mm	P.V.P. unid. €	
<b>138004</b>	3	10	100	<b>3,78</b>	10
<b>138005</b>	4	10	120	<b>4,05</b>	10
<b>138006</b>	5	12	120	<b>4,23</b>	10
<b>138007</b>	6	12	120	<b>4,66</b>	10
<b>138008</b>	8	12	120	<b>4,79</b>	10

**Granete automático**



- Cuerpo fabricado en acero
- Punta fabricada en acero HSS
- Cabeza de plástico
- Potencia regulable

Code	L mm	P.V.P. unid. €	
<b>138021</b>	135	<b>12,00</b>	6

Se suministra en blister

**Juego de Botadores cilíndricos**



**COMPOSICION**

2, 3, 4, 5, 6, 8 mm

Code	Nº Piezas	P.V.P. unid. €	
<b>140029</b>	6	<b>28,00</b>	1

**Juego de Botadores cónicos + granete**



**COMPOSICION**

• 5 botadores cónicos 2, 3, 4, 5, 6 mm • 1 granete 4 mm

Code	Nº Piezas	P.V.P. unid. €	
<b>140019</b>	6	<b>23,00</b>	1

**Juego de botadores y cincelos**



**COMPOSICION**

- 1 Cincel 12x10x150 mm
- 1 Granete 5 mm
- 2 Botadores cónicos de 3 y 4 mm
- 1 Buril 4x10x130
- 1 Botador Cilíndrico 5 mm

Code	Nº Piezas	P.V.P. unid. €	
<b>140050</b>	6	<b>29,50</b>	1

## Cinzel con protector

ACERO  
CR-SI-MO

Zona del ala en plástico de alta resistencia para una mejor protección de la mano

Protector ergonómico adaptado a la forma de la mano

Zona de golpeo templada a 40 HRC

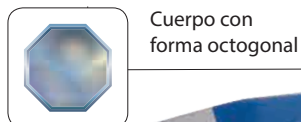

Code	L mm	B x A mm	P.V.P. unid. €	
<b>196956</b>	250	16x23	<b>11,00</b>	6
<b>196961</b>	300	16x23	<b>11,50</b>	6
<b>196966</b>	350	18x26	<b>12,50</b>	6
<b>196971</b>	400	18x26	<b>14,50</b>	6

## Puntero con protector

ACERO  
CR-SI-MO



Cabeza pulida reafilable



Code	L mm	B x A mm	P.V.P. unid. €	
<b>196911</b>	250	16x23	<b>10,50</b>	6
<b>196916</b>	300	16x23	<b>12,00</b>	6
<b>196921</b>	350	18x26	<b>14,00</b>	6
<b>196926</b>	400	18x26	<b>16,00</b>	6

## Protector bimaterial



- 196975 para cinces de Ø 16 mm
- 196977 para cinces de Ø 18 mm

Code	L mm	Ø exterior	P.V.P. unid. €	
<b>196975</b>	150	26	<b>4,62</b>	6
<b>196977</b>	150	32	<b>4,62</b>	6

## Cinzel extrafuerte

ACERO  
CR-SI-MO



Cabeza pulida reafilable

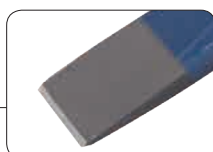

### CUERPO OCTOGONAL EXTRA FUERTE



Code	L mm	BxA mm	P.V.P. unid. €	
<b>196952</b>	200	18x20	<b>9,00</b>	6
<b>196957</b>	250	20x23	<b>11,50</b>	6
<b>196962</b>	300	20x23	<b>12,80</b>	6

Se suministra con colgador



## Cinzel

ACERO  
CR-SI-MO



Cabeza pulida reafilable

- Cuerpo octogonal
- Zona de trabajo templada a 55 HRC

Code	L mm	B x A mm	P.V.P. unid. €	
<b>196950</b>	200	16x23	<b>5,90</b>	6
<b>196955</b>	250	16x23	<b>6,10</b>	6
<b>196960</b>	300	16x23	<b>7,00</b>	6
<b>196965</b>	350	18x26	<b>9,00</b>	6
<b>196970</b>	400	18x26	<b>10,00</b>	6

Se suministra con colgador

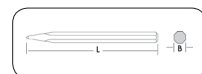

## Puntero

ACERO  
CR-SI-MO



Cabeza pulida reafilable

- Cuerpo octogonal
- Zona de trabajo templada a 55 HRC

Code	L mm	B x A mm	P.V.P. unid. €	
<b>196905</b>	200	14x20	<b>5,23</b>	6
<b>196910</b>	250	16x23	<b>5,91</b>	6
<b>196915</b>	300	16x23	<b>6,53</b>	6
<b>196920</b>	350	18x26	<b>8,50</b>	6
<b>196925</b>	400	18x26	<b>9,20</b>	6

Se suministra con colgador



## Cinzel para electricista

ACERO  
CR-SI-MO



Cabeza pulida reafilable

- Cuerpo octogonal
- Zona de trabajo templada a 55 HRC

Code	L mm	B x A mm	P.V.P. unid. €	
<b>196930</b>	200	10x12	<b>5,00</b>	6
<b>196935</b>	250	10x12	<b>5,50</b>	6
<b>196940</b>	300	10x12	<b>6,00</b>	6

## Expositor de cinceles y punteros



### COMPOSICION

- 6 Cinceles de 200 x 14 mm
- 6 Cinceles de 250 x 16 mm
- 6 Cinceles de 300 x 16 mm
- 6 Cinceles de 350 x 18 mm
- 6 Cinceles de 400 x 18 mm
- 6 Punteros de 200 x 14 mm
- 6 Punteros de 250 x 16 mm
- 6 Punteros de 300 x 16 mm
- 6 Punteros de 350 x 18 mm
- 6 Punteros de 400 x 18 mm

Code	Nº piezas	P.V.P. unid. €	
<b>196979</b>	60	<b>440,00</b>	1

## Cortafíos con protector

ACERO  
CR-SI-MO



Code	L mm	AxBxH mm	P.V.P. unid. €	
<b>197456</b>	250	26x23x13	<b>12,70</b>	6
<b>197471</b>	300	30x23x13	<b>15,20</b>	6
<b>197473</b>	350	30x23x13	<b>16,00</b>	6
<b>197475</b>	400	30x23x13	<b>17,50</b>	6

## Cortafíos

ACERO  
CR-SI-MO



Code	L mm	AxBxH mm	P.V.P. unid. €	
<b>197450</b>	200	24x23x13	<b>10,00</b>	6
<b>197455</b>	250	26x23x13	<b>10,50</b>	6
<b>197470</b>	300	30x23x13	<b>12,00</b>	6
<b>197472</b>	350	30x23x13	<b>13,00</b>	6
<b>197474</b>	400	30x23x13	<b>16,50</b>	6

## Cinzel para ranuras

ACERO  
CR-SI-MO



- Puntas pulidas reafilables
- Presentación pintado



Code	L mm	AxBxH mm	P.V.P. unid. €	
<b>197460</b>	250	50x23x13	<b>15,00</b>	6
<b>197465</b>	250	70x23x13	<b>17,50</b>	6

## Cinzel para ranuras con protector



Code	L mm	AxBxH mm	P.V.P. unid. €	
<b>197461</b>	250	50x23x13	<b>18,30</b>	6
<b>197466</b>	250	70x23x13	<b>20,70</b>	6

**Escarpa plana**

ACERO  
CR-SI-MO



- Puntas pulidas reafilables
- Presentación pintado

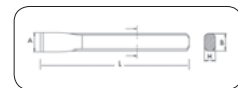

Code	L mm	BxH mm	P.V.P. unid. €	
<b>197480</b>	240	25x7	<b>10,00</b>	6

**Escarpa plana con protector**



Code	L mm	BxH mm	P.V.P. unid. €	
<b>197481</b>	240	25x7	<b>12,30</b>	6

**Buril**

ACERO  
CR-SI-MO



- Puntas pulidas reafilables
- Presentación pintado

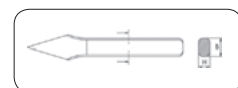

Code	L mm	BxH mm	P.V.P. unid. €	
<b>197001</b>	200	23x13	<b>9,90</b>	6
<b>197003</b>	250	23x13	<b>11,50</b>	6

**Protector bimaterial**



Para cortafríos, cinceles para ranuras y buriles

Code	L mm	Para	P.V.P. unid. €	
<b>196994</b>	150	-	<b>4,00</b>	6
<b>196989</b>	130	197480	<b>3,71</b>	6

**Expositor Cortafríos y Botadores**



Code	Nº Piezas	P.V.P. unid. €	
<b>196995</b>	66	<b>465,00</b>	1



## 09 Corte y taladrado



Arco de Sierra 183



Serrucho 184



Cuchillo de sierra 185



Cutter de cuchillas 186



Cutter de aluminio 188



Formón 189



Lima 190



Escofina 193



Cepillo metálico 194



Cepillo manual 197



Corona perforadora 198



Broca para metal 200



Juego de machos y cojinetes 201



Broca para hormigón 202



Broca plana 204



Barreno 205



**Arco de sierra reforzado**



Incluye hoja de sierra para madera y plástico de 6 dpp

**HOJA BIMETALICA DE 300 MM. CAPACIDAD DE TENSION 2000 Kg /cm<sup>2</sup>**

- Cuerpo de Aluminio
- Amarre y regulación mediante palanca
- Mango recubierto de elastómero antideslizante
- Posibilidad de amarre de la hoja a 45° ó 90°
- Almacen de hojas de sierra

Code	L total mm	P.V.P. unid. €	
<b>144093</b>	400	<b>19,77</b>	6

**Arco de sierra, cuerpo de aluminio**



**HOJA BIMETALICA DE 300 MM.**

- Cuerpo de Aluminio
- Amarre y regulación mediante mariposa
- Hoja de sierra bimetalica
- Posibilidad de amarre de la hoja a 45° ó 90°
- Posibilidad de amarre de la hoja en voladizo
- Almacen de hojas de sierra

Code	L total mm	P.V.P. unid. €	
<b>144004</b>	400	<b>13,00</b>	6

**Miniarco de sierra**



**INCLUYE:**



- Cuerpo de Aluminio
- Hoja de sierra de Acero al Carbono
- Con ruleta moleteada para bloqueo de la hoja
- Posibilidad de regular la apertura de la hoja

Code	L mm	P.V.P. unid. €	
<b>144000</b>	230	<b>7,50</b>	12

Se suministra en blister

**Hoja de sierra**



**BIMETALICA**



**UTILIZACION:**

- Metal
- Madera
- Plástico

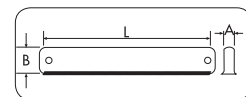

**300x13x0,65 mm**

- Hoja fabricada en Acero aleado de alta flexibilidad
- Filo corte dentado HSS soldado al cuerpo de la hoja
- Temple total entre 63-67 HRC

Code	Nº dientes	P.V.P. unid. €	
<b>197260</b>	24	<b>1,82</b>	100

Se suministra solo en expositor de 100 unidades

## Arco de sierra Junior

HOJA DE 150 MM



INCLUYE:

+2

Hojas

- Cuerpo de Acero
- Mango bimaternal en plástico duro ABS y goma antideslizante TPR
- Hoja de sierra de Acero al Carbono de 24 dpp

Code	L total mm	P.V.P. unid. €	
<b>144035</b>	225	<b>7,50</b>	6

### HOJAS DE RECAMBIO

<b>144036</b>	Envase 10 unidades	<b>5,60</b>	1
---------------	--------------------	-------------	---

Hojas unidad de venta envase de 10 unidades

## Serrucho

### DENTADO STANDARD



- Dos superficies de corte
- Aserrado a favor y en contra



Code	L "	L mm	P.V.P. unid. €	
<b>144055</b>	16	400	<b>10,00</b>	6
<b>144065</b>	18	450	<b>11,00</b>	6
<b>144075</b>	22	550	<b>13,00</b>	6

## Serrucho de costilla

### DENTADO STANDARD

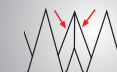

## Serrucho de ebanista

### DENTADO STANDARD

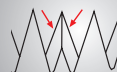

Code	L "	L mm	P.V.P. unid. €	
<b>144086</b>	10	250	<b>7,27</b>	10

Code	L "	L mm	P.V.P. unid. €	
<b>144088</b>	12	300	<b>9,00</b>	10

## Serrucho para PVC

### UTILIZACION:

- Plástico
- Placa de yeso
- Revestimientos de madera
- Contrachapados de madera

- Hoja fabricada en Acero
- Dentado templado
- Hoja con punta para penetración en yeso
- Mango reforzado bimaternal

Code	L "	L mm	P.V.P. unid. €	
<b>144087</b>	10	250	<b>9,39</b>	10

## Conjunto serrucho de costilla y caja de ingletear

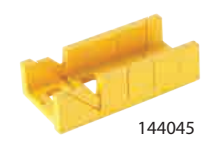

Code	P.V.P. unid. €	
<b>144046</b>	<b>15,83</b>	1

## Caja de ingletear de plástico

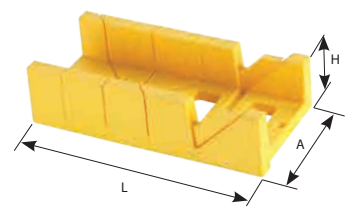

• Fabricado en plástico duro ABS

Code	L mm	A mm	H mm	P.V.P. unid. €	
<b>144040</b>	300	80	60	<b>5,54</b>	1
<b>144045</b>	300	140	60	<b>7,49</b>	1

## Cuchillo de sierra de mango recto

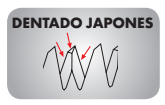

**HOJA DE 160 MM**

Code	L "	L mm	P.V.P. unid. €	
<b>144098</b>	12	300	<b>8,50</b>	6

## Serrucho de calar



**HOJA DE 325 MM**

Code	L "	L mm	P.V.P. unid. €	
<b>144099</b>	18,5	470	<b>9,50</b>	6

## Arco de tronzar



Code	L hoja "	L hoja mm	P.V.P. unid. €	
<b>144020</b>	21	525	<b>8,50</b>	6
<b>144025</b>	24	600	<b>9,50</b>	6
<b>144030</b>	30	750	<b>11,00</b>	6

## Hoja de tronzar. Dentado standard

**PARA MADERA SECA**



• Fabricada en Acero al Carbono



Code	L "	L mm	P.V.P. unid. €	
<b>144021</b>	21	525	<b>1,90</b>	10
<b>144026</b>	24	600	<b>2,20</b>	10
<b>144031</b>	30	750	<b>2,30</b>	10

## Hoja de tronzar. Dentado Americano

**PARA MADERA VERDE**



Code	L "	L mm	P.V.P. unid. €	
<b>144022</b>	21	525	<b>1,80</b>	10
<b>144027</b>	24	600	<b>2,00</b>	10
<b>144032</b>	30	750	<b>2,20</b>	10

## CARACTERÍSTICAS DE LAS CUCHILLAS

### CERÁMICA



VIDA ÚTIL

**x40**

ANTI CORROSIÓN



ALIMENTACIÓN



#### RECOMENDADO PARA:

Ambientes ácidos, agua salada, corrosión y presencia de alimentos

Resistente a la abrasión, no reacciona con los alimentos y evita olores

### ACERO SK2H



PRECISIÓN DE CORTE

**x5**

VIDA ÚTIL

**x3**

### ACERO SK2



PRECISIÓN DE CORTE

**x1,3**

VIDA ÚTIL

**x2**

Comparación en vida útil y precisión corte con cuchillas de acero SK5

Code	Dispensador	cuchilla	material	medida	nº cuchillas envase	para cutter	P.V.P. envase €	
<b>186640</b>			SK2H	60 mm	10	186650 • 186660	<b>2,45</b>	10
<b>186642</b>			SK2	60 mm	10	186650 • 186660	<b>1,36</b>	10
<b>186645</b>			SK2H	49 mm	10	186650 • 186660	<b>3,22</b>	10
<b>186612</b>			SK2H	9 mm	10	186609 • 186610	<b>2,34</b>	10
<b>186632</b>			SK2H	18 mm	10	186618 • 186619 186615 • 186616	<b>2,72</b>	10
<b>186630</b>			SK2	18 mm	10	186618 • 186619 186615 • 186616	<b>1,40</b>	10
<b>186635</b>			CERÁMICA	18 mm	10	186618 • 186619 186615 • 186616	<b>16,90</b>	10
<b>186626</b>			SK2H	25 mm	10	186625	<b>4,43</b>	10

Unidad de venta envase de 10 unidades

### Cutter reforzado 18 mm



ACERO SK2H

18 mm

Guías metálicas de acero inoxidable 0,8 mm

Cuchilla fragmentable con 8 filos de corte aprovechables



Mango con diseño antideslizante

Botón fijador autolock

Mango reforzado de aluminio

**Nuevo**



160x90x20 mm  
120 gr

#### CUCHILLAS UTILIZABLES:

186632/186630/186635  
ver encima

Code	P.V.P. unid. €	
<b>186615</b>	<b>5,55</b>	10

Se suministra en blister

### Cutter de seguridad 18 mm



ACERO SK2H

18 mm

Guías metálicas de acero inoxidable 0,8 mm

Cuchilla fragmentable con 8 filos de corte aprovechables



Mango con diseño antideslizante

Botón para retener la cuchilla

Botón fijador autolock



La cuchilla se retrae si no está presionada, evitando cortes accidentales

**Nuevo**



190x45x22 mm  
85 gr

#### CUCHILLAS UTILIZABLES:

186632/186630/186635  
ver encima

Code	P.V.P. unid. €	
<b>186616</b>	<b>4,75</b>	10

Se suministra en blister

**Nuevo**

**Cutter 18 mm con botón fijador**

**18 mm**  
**ACERO SK2H**

**CUCHILLAS UTILIZABLES:**

186630 / 186632 / 186635  
Ver página 186

  
160x45x20 mm  
65 gr



Botón fijador autolock

- Guía metálica en acero inox. de 0,8 mm
- Mango de plástico ABS recubierto de goma TPR rígido y antideslizante
- Almacén para dos cuchillas

Code	P.V.P. unid. €	
<b>186618</b>	<b>3,34</b>	10

Se suministra en blister

**Nuevo**

**Cutter 18 mm con ruleta de seguridad**

**18 mm**  
**ACERO SK2H**

**CUCHILLAS UTILIZABLES:**

186630 / 186632 / 186635  
Ver página 186

  
160x45x20 mm  
65 gr



Ruleta de seguridad

- Guía metálica en acero inox. de 0,8 mm
- Mango de plástico ABS recubierto de goma TPR rígido y antideslizante
- Almacén para dos cuchillas

Code	P.V.P. unid. €	
<b>186619</b>	<b>3,43</b>	10

Se suministra en blister

**Nuevo**

**Cutter 18 mm + dispensador en bolsa de nylon**

**18 mm**  
**ACERO SK2H**



  
**+10**

**COMPOSICION**

- Cutter 18 mm 186618
- Dispensador 10 cuchillas 186632
- Bolsa de nylon

  
190x70x50 mm  
180 gr



Alojamiento para acoplar a cinturón



190x70x50 mm  
180 gr

Code	Nº piezas	P.V.P. unid. €	
<b>186622</b>	3	<b>10,50</b>	6

Se suministra en blister

**Nuevo**

**Cutter 25 mm con ruleta de seguridad**

**25 mm**  
**ACERO SK2H**

**CUCHILLAS UTILIZABLES:**

186626  
ver página 186

  
175x40x35 mm  
125 gr



- Guía metálica en acero inox. de 1 mm
- Mango de plástico ABS recubierto de goma TPR rígido y antideslizante
- Almacén para dos cuchillas

Code	P.V.P. unid. €	
<b>186625</b>	<b>4,60</b>	10

Se suministra en blister

## Cutter 9 mm



  
145x20x15 mm  
20 gr

**Nuevo**

### CUCHILLAS UTILIZABLES:

186612  
ver página 186

- Guía metálica en acero inox. de 0,8 mm
- Mango de plástico ABS recubierto de goma TPR rígido y antideslizante

Code	P.V.P. unid. €	
<b>186609</b>	<b>2,20</b>	10

Se suministra en blister

## Cutter 9 mm extrafino



  
150x13x13 mm  
18 gr

**Nuevo**

### CUCHILLAS UTILIZABLES:

186612  
ver página 186

- Guía metálica en acero inox. de 0,8 mm
- Mango de plástico ABS recubierto de goma TPR rígido y antideslizante

Code	P.V.P. unid. €	
<b>186610</b>	<b>2,25</b>	10

Se suministra en blister

## Cutter aluminio plegable



### CUCHILLAS UTILIZABLES:

186640 / 186642 / 186645  
ver página 186

- Cuchilla en Acero SK2H con protector de plástico
- Cuerpo en acero inoxidable
- Ruleta para cambio rápido de la cuchilla
- Mango de aluminio anodizado ergonómico
- Clip metálico en la parte posterior para colgar

**Nuevo**

Code	L mm		P.V.P. unid. €	
	cerrado	abierto		
<b>186660</b>	110	160	<b>12,00</b>	6

Se suministra en blister

## Cutter de seguridad



La cuchilla se retrae si no está presionada, evitando cortes accidentales

**MUY LIGERO**

### CUCHILLAS UTILIZABLES:

186640 / 186642 / 186645  
ver página 186

- Guía metálica en acero inox. de 0,8 mm
- Mango de plástico ABS

**Nuevo**

Code	P.V.P. unid. €	
<b>186650</b>	<b>4,00</b>	10

Se suministra en blister



  
155x40x26 mm  
75 gr

**Formón mango plástico**

ACERO  
CR-V



Code	A mm	P.V.P. unid. €	
125001	6	9,84	6
125002	8	9,85	6
125003	10	10,28	6
125004	12	10,33	6
125005	14	10,35	6
125035	16	10,54	6
125007	18	11,74	6
125008	20	12,03	6
125009	22	13,27	6
125010	25	14,61	6
125011	30	15,00	6
125036	32	15,50	6
125012	35	16,00	6
125037	38	16,50	6

Se suministra con colgador

**Formón mango de madera**

ACERO  
CR-V



Code	A mm	P.V.P. unid. €	
125013	6	9,96	6
125014	8	10,00	6
125015	10	10,84	6
125016	12	11,06	6
125017	14	11,67	6
125038	16	11,97	6
125019	18	12,67	6
125020	20	12,91	6
125021	22	14,38	6
125022	25	15,35	6
125023	30	16,69	6
125039	32	17,32	6
125024	35	18,00	6
125040	38	18,48	6

Se suministra con colgador

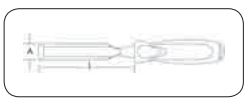

- Superficie de la hoja rectificada
- Refuerzo metálico para golpeo
- Mango ergonómico
- Se suministra con protector de filo

**Juego de Formones**



125050



125060

**COMPOSICION** 3 formones: 12, 20, 25 mm

Code	Nº Piezas	P.V.P. unid. €	
125050	3	38,00	1
125060	3	40,00	1

**Rasqueta reforzada 100 mm**

INCLUYE:  
**+10**  
Cuchillas

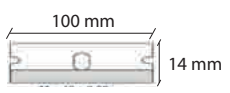

Code	L mm	P.V.P. unid. €	
195580	300	11,00	6

Se suministra en blister

CUCHILLAS DE RECAMBIO			
195582		1,75	10

Cuchillas en blister de 10 unidades

## Lima



Medida mm	Basto	Entrefino
100	14	20
150	11	16
200	10	14
250	9	12
300	8	11
350	7	10

Nº de dientes por cada 10 mm

	<b>Lima plana</b>
	<b>Lima de media caña</b>
	<b>Lima redonda</b>
	<b>Lima cuadrada</b>
	<b>Lima triangular</b>

Zona de trabajo templada entre 60÷65 HRC

## Lima plana

ACERO CARBONO



DENTADO ENTREFINO					
Code	L "	L mm	Nº dientes	P.V.P. unid. €	
<b>197499</b>	4	100	20	<b>4,29</b>	6
<b>197500</b>	6	150	16	<b>5,09</b>	6
<b>197502</b>	8	200	14	<b>7,46</b>	6
<b>197504</b>	10	250	12	<b>10,02</b>	6
<b>197505</b>	12	300	11	<b>12,65</b>	6
<b>197506</b>	14	350	10	<b>13,40</b>	6

DENTADO BASTO					
Code	L "	L mm	Nº dientes	P.V.P. unid. €	
<b>197702</b>	8	200	10	<b>6,95</b>	6
<b>197704</b>	10	250	9	<b>9,33</b>	6
<b>197705</b>	12	300	8	<b>11,77</b>	6

Se suministra con colgador

## Lima media caña

ACERO CARBONO



DENTADO ENTREFINO					
Code	L "	L mm	Nº dientes	P.V.P. unid. €	
<b>197509</b>	4	100	20	<b>4,59</b>	6
<b>197510</b>	6	150	16	<b>5,39</b>	6
<b>197512</b>	8	200	14	<b>8,08</b>	6
<b>197514</b>	10	250	12	<b>11,25</b>	6
<b>197515</b>	12	300	11	<b>13,42</b>	6
<b>197516</b>	14	350	10	<b>14,62</b>	6

DENTADO BASTO					
Code	L "	L mm	Nº dientes	P.V.P. unid. €	
<b>197710</b>	8	200	10	<b>7,52</b>	6
<b>197712</b>	10	250	9	<b>10,47</b>	6
<b>197714</b>	12	300	8	<b>12,48</b>	6

Se suministra con colgador



**Lima redonda**

ACERO CARBONO



**DENTADO ENTREFINO**

Code	L "	L mm	Nº dientes	P.V.P. unid. €	
<b>197518</b>	4	100	20	<b>4,00</b>	6
<b>197519</b>	6	150	16	<b>4,58</b>	6
<b>197520</b>	8	200	14	<b>6,50</b>	6
<b>197521</b>	10	250	12	<b>8,91</b>	6

**DENTADO BASTO**

Code	L "	L mm	Nº dientes	P.V.P. unid. €	
<b>197720</b>	8	200	10	<b>6,02</b>	6
<b>197721</b>	10	250	9	<b>8,29</b>	6

Se suministra con colgador

**Lima cuadrada**

ACERO CARBONO

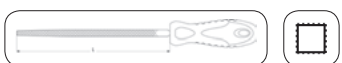

**Lima triangular**

ACERO CARBONO



**DENTADO ENTREFINO**

Code	L "	L mm	Nº dientes	P.V.P. unid. €	
<b>197528</b>	4	100	20	<b>3,82</b>	6
<b>197529</b>	6	150	16	<b>5,00</b>	6
<b>197530</b>	8	200	14	<b>6,90</b>	6
<b>197531</b>	10	250	12	<b>9,16</b>	6

**DENTADO BASTO**

Code	L "	L mm	Nº dientes	P.V.P. unid. €	
<b>197730</b>	8	200	10	<b>6,22</b>	6

Se suministra con colgador

**DENTADO ENTREFINO**

Code	L "	L mm	Nº dientes	P.V.P. unid. €	
<b>197524</b>	6	150	16	<b>5,00</b>	6
<b>197525</b>	8	200	14	<b>6,52</b>	6
<b>197526</b>	10	250	12	<b>8,97</b>	6

**DENTADO BASTO**

Code	L "	L mm	Nº dientes	P.V.P. unid. €	
<b>197725</b>	8	200	10	<b>5,84</b>	6

Se suministra con colgador

**Lima para motosierras**

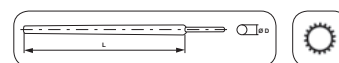

**Empleo en afilado de cadenas de motosierra**

Code	L mm	Ø mm	P.V.P. unid. €	
<b>197601</b>	150	3,5	<b>2,50</b>	6
<b>197603</b>	200	4,5	<b>2,70</b>	6
<b>197605</b>	200	5,5	<b>2,85</b>	6

Se suministra en bolsa





## Juego de limas entrefinas en bolsa de nylon



**ENTREFINO L 200 MM**



### COMPOSICION

-  • 1 lima plana de 200 mm (197502)
-  • 1 lima de media caña de 200 mm (197512)
-  • 1 lima redonda de 200 mm (197520)
-  • 1 lima cuadrada de 200 mm (197525)
-  • 1 lima triangular de 200 mm (197530)





Code	Nº Piezas	P.V.P. unid. €	
<b>197550</b>	5	<b>35,44</b>	1



**ENTREFINO L 150 MM**



### COMPOSICION

-  • 1 lima plana de 150 mm (197500)
-  • 1 lima de media caña de 150 mm (197510)
-  • 1 lima redonda de 150 mm (197519)
-  • 1 lima cuadrada de 150 mm (197524)
-  • 1 lima triangular de 150 mm (197529)

Code	Nº Piezas	P.V.P. unid. €	
<b>197552</b>	5	<b>24,68</b>	1





## Juego de limas bastas en bolsa de nylon



**BASTO L 200 MM**



### COMPOSICION

-  • 1 lima plana de 200 mm (197702)
-  • 1 lima de media caña de 200 mm (197710)
-  • 1 lima redonda de 200 mm (197720)
-  • 1 lima cuadrada de 200 mm (197725)
-  • 1 lima triangular de 200 mm (197730)

Code	Nº Piezas	P.V.P. unid. €	
<b>197554</b>	5	<b>37,00</b>	1







## Juego de limas de aguja



**Ø 3 MM  
L 100 MM**

- Acero aleado templado HRC62
- Longitud de hoja 100 mm

### COMPOSICION

-  • 1 lima plana de 100 mm
-  • 1 lima de media caña de 100 mm
-  • 1 lima redonda de 100 mm
-  • 1 lima cuadrada de 100 mm
-  • 1 lima triangular de 100 mm
-  • 1 lima plana punta de 100 mm

Code	Nº Piezas	P.V.P. unid. €	
<b>197495</b>	6	<b>10,70</b>	1

## Escofina de media caña

ACERO  
CARBONO



- Acero aleado templado entre 60 ÷ 65 HRC
- Dentado picado especial para trabajo sobre madera
- Mango ergonómico bimaterial

Code	L "	L mm	P.V.P. unid. €	
<b>197539</b>	6	150	<b>4,97</b>	6
<b>197540</b>	8	200	<b>7,80</b>	6
<b>197541</b>	10	250	<b>10,33</b>	6

Se suministra con colgador

## Escofina plana

ACERO  
CARBONO



Code	L "	L mm	P.V.P. unid. €	
<b>197534</b>	6	150	<b>5,00</b>	6
<b>197535</b>	8	200	<b>7,15</b>	6
<b>197536</b>	10	250	<b>9,75</b>	6

Se suministra con colgador

## Escofina redonda

ACERO  
CARBONO



Code	L "	L mm	P.V.P. unid. €	
<b>197544</b>	6	150	<b>4,20</b>	6
<b>197545</b>	8	200	<b>6,14</b>	6
<b>197546</b>	10	250	<b>8,52</b>	6

Se suministra con colgador

## Juego de escofinas en bolsa de nylon



L 200 MM



### COMPOSICION

- 1 escofina plana 200 mm (197535)
- 1 escofina media caña 200 mm (197540)
- 1 escofina redonda 200 mm (197545)

Code	Nº Piezas	P.V.P. unid. €	
<b>197549</b>	3	<b>21,10</b>	1

## Juego de miniescofinas en caja de plástico



Ø 3 MM  
L 100 MM

### COMPOSICION

- 1 miniescofina plana de 100 mm
- 1 miniescofina de media caña de 100 mm
- 1 miniescofina redonda de 100 mm
- 1 miniescofina cuadrada de 100 mm
- 1 miniescofina triangular de 100 mm
- 1 miniescofina plana punta de 100 mm

Code	Nº Piezas	P.V.P. unid. €	
<b>197497</b>	6	<b>13,32</b>	1

## Cepillo metálico circular



**Empleo en limpieza de cascarilla de piezas de forja y fundición. Eliminación de todo tipo de óxidos, pinturas y rebabas**



Cada cepillo se suministra con diferentes adaptadores para montar sobre ejes lisos: Ø 12, 16, 20, 22, 25 y 32 mm

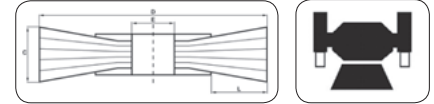
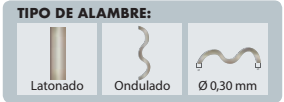

Code	Ø D mm	Filas	Ancho (C)	L mm	E mm	Máx.RPM	P.V.P. unid. €	
<b>197602</b>	150	5	20	30	32	6500	<b>14,44</b>	1
<b>197604</b>	175	5	20	45	32	6000	<b>15,94</b>	1
<b>197606</b>	200	5	20	55	32	4500	<b>18,12</b>	1

Se suministra en estuche individual

## Cepillo metálico circular ondulado



**Empleo en limpieza de cascarilla de piezas de forja y fundición. Eliminación de todo tipo de óxidos, pinturas y rebabas**

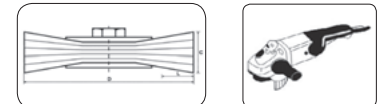
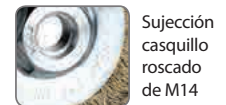

Code	Ø D mm	Ancho C	L mm	Máx. RPM	P.V.P. unid. €	
<b>197650</b>	115	20	30	8500	<b>9,50</b>	1
<b>197652</b>	115	20	30	8500	<b>18,00</b>	1

Se suministra en estuche individual

## Cepillo de taza ondulada



**Empleo en trabajos sobre superficies amplias**



Code	Ø D mm	L mm	Máx. RPM	P.V.P. unid. €	
<b>197610</b>	75	20	12500	<b>9,00</b>	1
<b>197614</b>	100	25	8500	<b>13,50</b>	1
<b>197612</b>	125	25	6500	<b>16,00</b>	1

Se suministra en estuche individual

**Cepillo de taza trenzado**



Sujección casquillo roscado de M14

**TIPO DE ALAMBRE:**



**Empleo sobre superficies amplias que requieran gran capacidad de arranque de material**



Code	Ø D mm	L mm	Máx. RPM	P.V.P. unid. €	
<b>197622</b>	100	25	8500	<b>16,71</b>	1
<b>197624</b>	125	25	6500	<b>20,77</b>	1

Se suministra en estuche individual

**Cepillo para miniamoladoras**



Sujección casquillo roscado de M14

**TIPO DE ALAMBRE:**



**Empleo sobre superficies amplias que requieran gran capacidad de arranque de material**



Code	Ø D mm	L mm	Máx. RPM	P.V.P. unid. €	
<b>197620</b>	75	25	12500	<b>10,00</b>	1

Se suministra en estuche individual

**Cepillo de arranque de pintura**



**Empleo en arranque de pintura**

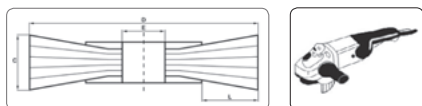

Code	Ø D mm	Ancho C	L mm	E mm	P.V.P. unid. €	
<b>197651</b>	100	15	35	12	<b>10,00</b>	6

Se suministra en blister

**Cepillo de arranque con vástago**

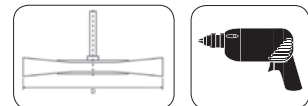

Code	Ø D mm	P.V.P. unid. €	
<b>197656</b>	75	<b>6,01</b>	6

Se suministra en blister

## Cepillo cilíndrico ondulado con vástago



**Empleo en trabajos de limpieza y eliminación de pinturas, óxidos y pequeñas rebabas**

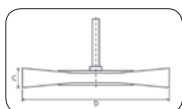

Code	Ø D mm	Ancho C	Máx. RPM	P.V.P. unid. €	
<b>197630</b>	50	6	4500	<b>2,30</b>	6
<b>197632</b>	75	6	4500	<b>3,02</b>	6
<b>197635</b>	100	6	4500	<b>3,80</b>	6

Se suministra en blister

## Cepillo de taza ondulado con vástago



Code	Ø D mm	L mm	Máx. RPM	P.V.P. unid. €	
<b>197640</b>	50	20	4500	<b>2,46</b>	6
<b>197642</b>	75	20	4500	<b>3,25</b>	6

Se suministra en blister

## Cepillo de brocha ondulado



**Empleo en trabajos de bricolaje en lugares de difícil acceso**

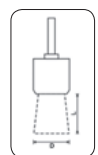

Code	Ø D mm	L mm	Máx. RPM	P.V.P. unid. €	
<b>197645</b>	24	25	4500	<b>3,54</b>	6

Se suministra en blister

## Cepillo cilíndrico ondulado con vástago

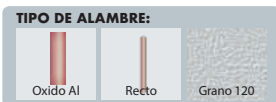

Filamentos flexibles de nylon con grano abrasivo

**Empleo en trabajos ligeros de bricolaje**

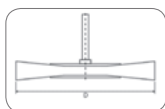

Code	Ø D mm	Máx. RPM	P.V.P. unid. €	
<b>197655</b>	75	4500	<b>6,85</b>	6
<b>197658</b>	100	4500	<b>8,07</b>	6

Se suministra en blister

## Cepillo de taza ondulado con vástago



Code	Ø D mm	L mm	Máx. RPM	P.V.P. unid. €	
<b>197660</b>	50	20	4500	<b>7,00</b>	6
<b>197662</b>	75	20	4500	<b>7,91</b>	6

Se suministra en blister

**Cepillo manual de acero latonado reforzado**

**25% MAYOR DENSIDAD DE ALAMBRES**

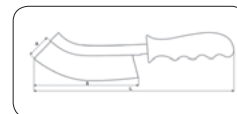

**Empleo en trabajos ligeros y en lugares de difícil acceso**

Code	L mm	A mm	S mm	P.V.P. unid. €	
<b>197556</b>	225	28	125	<b>2,40</b>	24

**Cepillo manual de acero latonado**



**Cepillo manual de acero inoxidable**



Especialmente indicado para cepillar Acero inoxidable

Code	L mm	A mm	S mm	P.V.P. unid. €	
<b>197555</b>	225	28	125	<b>1,91</b>	24

Code	L mm	A mm	S mm	P.V.P. unid. €	
<b>197558</b>	225	28	125	<b>4,30</b>	24

**Minicepillo de acero latonado**



**Minicepillo de acero inoxidable**



Indicado para cepillar Acero inoxidable

Code	L mm	P.V.P. unid. €	
<b>197561</b>	150	<b>2,50</b>	24

Code	L mm	P.V.P. unid. €	
<b>197562</b>	150	<b>2,60</b>	24

**Cepillo manual con mango de madera**

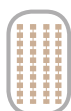

Trabajos ligeros de limpieza de pinturas, óxidos y rebabas, etc.

**Cepillo manual de fundición**

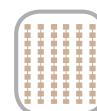

Trabajos fuertes de cepillado

Code	L mm	A mm	S mm	P.V.P. unid. €	
<b>197560</b>	300	28	135	<b>2,21</b>	12

Code	L mm	A mm	P.V.P. unid. €	
<b>197565</b>	200	34	<b>3,80</b>	12

## Corona perforadora

**BIMETALICA**



Coronas para aplicaciones en metales, maderas y plásticos en general

Máxima profundidad de corte de 38mm



Base de la corona reforzada para reducir las vibraciones que se producen durante el corte



Dentado variable 4/6 con ángulo de corte positivo

Ventanas laterales de expulsión del material cortado

### INSTRUCCIONES DE USO

Dentro de cada caja de cartón se incluye una hoja técnica con las RPM que han de utilizarse en función del material a cortar y el diámetro de corona a emplear.

- Dentado en acero rápido (HSS). Temple entre 63-65 HRC
- Cuerpo fabricado en acero aleado de gran flexibilidad
- Soldado por haz de electrones

Code	Ø mm	P.V.P. unid. €		Code	Ø mm	P.V.P. unid. €		Code	Ø mm	P.V.P. unid. €	
197014	14	8,24	1	197041	41	11,76	1	197076	76	18,13	1
197016	16	8,24	1	197043	43	12,03	1	197079	79	18,87	1
197017	17	8,24	1	197044	44	12,47	1	197083	83	19,78	1
197019	19	8,24	1	197046	46	12,78	1	197086	86	20,08	1
197020	20	8,24	1	197048	48	12,78	1	197089	89	20,86	1
197021	21	8,53	1	197051	51	13,17	1	197092	92	22,77	1
197022	22	8,53	1	197052	52	13,26	1	197095	95	24,53	1
197024	24	8,92	1	197054	54	13,49	1	197098	98	25,54	1
197025	25	8,92	1	197056	56	13,69	1	197102	102	26,97	1
197027	27	9,60	1	197057	57	13,87	1	197105	105	28,40	1
197029	29	9,60	1	197059	59	14,25	1	197108	108	34,83	1
197030	30	10,34	1	197060	60	14,62	1	197111	111	37,48	1
197032	32	10,34	1	197064	64	15,29	1	197114	114	42,17	1
197033	33	10,34	1	197065	65	15,64	1	197121	121	48,30	1
197035	35	11,05	1	197067	67	16,02	1	197127	127	51,61	1
197037	37	11,19	1	197068	68	16,34	1	197140	140	61,15	1
197038	38	11,36	1	197070	70	16,72	1	197152	152	65,24	1
197040	40	11,76	1	197073	73	17,45	1				

## Husillo para coronas

**PARA CORONAS DE Ø 14-30 MM**



- Husillo fabricado en acero aleado de gran elasticidad
- Broca guía en acero rápido HSS

**PARA CORONAS DE Ø 32-152 MM**



Code	Hexágono	P.V.P. unid. €	
197210	3/8"	10,00	1

Code	Hexágono	P.V.P. unid. €	
197200	7/16"	16,00	1



**Husillo SDS-Plus**

**PARA CORONAS DE Ø 32-152 MM**



Mango SDS-Plus

Code	P.V.P. unid. €	
<b>197212</b>	<b>19,00</b>	1

**Juego de coronas electricista**



**COMPOSICION**

- 6 Coronas: 22, 29, 35, 44, 51, 64 mm
- 2 Husillos para Coronas: 7/16" (32-152), 3/8" (14-30)
- 1 Llave Allen para Husillos

Code	Nº piezas	P.V.P. unid. €	
<b>197160</b>	9	<b>85,00</b>	1

**Juego de coronas electricista / fontanero**



**COMPOSICION**

- 9 Coronas: 19, 22, 29, 35, 38, 44, 51, 57, 64 mm
- 2 Husillos para Coronas: 7/16" (32-152), 3/8" (14-30)
- 1 Llave Allen para Husillos

Code	Nº piezas	P.V.P. unid. €	
<b>197170</b>	12	<b>105,00</b>	1

**Broca guía para husillos**



Code	L mm	P.V.P. unid. €	
<b>197215</b>	1/4"x81	<b>3,77</b>	10
<b>197220</b>	1/4"x102	<b>3,92</b>	10

**Alargadera para husillos**



Code	L mm	P.V.P. unid. €	
<b>197250</b>	300	<b>15,04</b>	1

**Adaptador**



• Para utilizar con coronas desde 32 mm, con husillo de 3/8"

Code	P.V.P. unid. €	
<b>197230</b>	<b>5,41</b>	10

**Muelle**



Code	P.V.P. unid. €	
<b>197240</b>	<b>0,94</b>	10

## Broca para metal HSS

DIN  
338

ACERO  
HSS



Hélice endurecida a 63-66 HRC

Punta 135°



Afilado autocentrante (SP)

Code	Ø mm	P.V.P. unid. €		Code	Ø mm	P.V.P. unid. €		Code	Ø mm	P.V.P. unid. €	
120100	1	0,40	10	120525	5,25	0,90	10	120925	9,25	2,60	10
120125	1,25	0,42	10	120550	5,50	0,90	10	120950	9,50	3,00	10
120150	1,50	0,42	10	120575	5,75	0,90	10	120975	9,75	3,00	10
120175	1,75	0,42	10	120600	6	1,20	10	121000	10	3,40	10
120200	2	0,42	10	120625	6,25	1,20	10	121025	10,25	3,40	5
120225	2,25	0,42	10	120650	6,50	1,30	10	121050	10,50	3,70	5
120250	2,50	0,42	10	120675	6,75	1,30	10	121075	10,75	4,00	5
120275	2,75	0,42	10	120700	7	1,50	10	121100	11	4,20	5
120300	3	0,50	10	120725	7,25	1,50	10	121125	11,25	4,20	5
120325	3,25	0,50	10	120750	7,50	1,50	10	121150	11,50	4,20	5
120350	3,50	0,70	10	120775	7,75	1,50	10	121175	11,75	4,20	5
120375	3,75	0,70	10	120800	8	2,00	10	121200	12	5,50	5
120400	4	0,75	10	120825	8,25	2,00	10	121225	12,25	5,50	5
120425	4,25	0,75	10	120850	8,50	2,00	10	121250	12,50	5,50	5
120450	4,50	0,75	10	120875	8,75	2,00	10	121275	12,75	5,50	5
120475	4,75	0,80	10	120900	9	2,60	10	121300	13	6,00	5
120500	5	0,90	10								

## Juego de brocas HSS



**COMPOSICION** 1-10 x 0,5 mm  
1, 1'5, 2, 2'5, 3, 3'5, 4, 4'5, 5, 5'5, 6, 6'5, 7, 7'5, 8, 8'5, 9, 9'5, 10 mm

Code	Nº piezas	P.V.P. unid. €	
121320	19	34,04	1



**COMPOSICION** 1-13 x 0,5 mm  
1, 1'5, 2, 2'5, 3, 3'5, 4, 4'5, 5, 5'5, 6, 6'5, 7, 7'5, 8, 8'5, 9, 9'5, 10, 10'5, 11, 11'5, 12, 12'5, 13 mm

Code	Nº piezas	P.V.P. unid. €	
121330	25	69,88	1

**Juego de brocas HSS**



**COMPOSICION** 1, 2, 3, 4, 5, 6, 7, 8, 9, 10 mm

Code	Nº piezas	P.V.P. unid. €	
<b>121310</b>	10	<b>20,00</b>	1



**COMPOSICION** 1-10 x 0,5 mm  
1, 1'5, 2, 2'5, 3, 3'5, 4, 4'5, 5, 5'5, 6, 6'5, 7, 7'5, 8, 8'5, 9, 9'5, 10 mm

Code	Nº piezas	P.V.P. unid. €	
<b>121335</b>	19	<b>31,44</b>	1

**Juego de machos y cojinetes en caja metálica**



**COMPOSICION**  
 • 21 Machos HSS: M3, M4, M5, M6, M8, M10, M12 (x3)  
 • 7 Cojinetes HSS: M3, M4, M5, M6, M8, M10, M12  
 • 1 Portamachos forjado  
 • 1 Portacojinetes forjado  
 • 1 Avellanador

Code	Nº piezas	P.V.P. unid. €	
<b>121350</b>	31	<b>180,00</b>	1

**Portamachos**



Code	Para métrica	L mm	P.V.P. unid. €	
<b>122347</b>	M3 - M12	210	<b>9,90</b>	1

Se suministra en blister

**Portacojinetes**



Code	Ø mm	L mm	P.V.P. unid. €	
<b>122342</b>	25,4	210	<b>7,10</b>	1

Se suministra en blister

**Volvedor para machos de roscar**

ACERO CR-V



• Terminación satinado mate

Code	Para métrica	L mm	P.V.P. unid. €	
<b>122340</b>	M3 - M8	85	<b>21,35</b>	1
<b>122345</b>	M5 - M12	100	<b>24,88</b>	1

Se suministra con colgador

## Broca de mango cilíndrico para hormigón

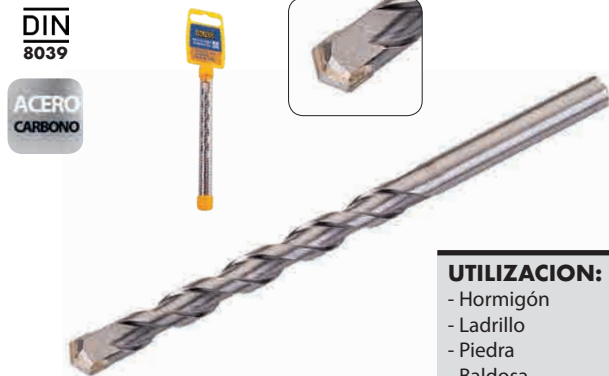

### UTILIZACION:

- Hormigón
- Ladrillo
- Piedra
- Baldosa
- Mármol
- Granito
- Pizarra

- Fabricada en Acero al Carbono templado
- Hélice fresada
- Punta fabricada en Carburo de Tungsteno, lo que le confiere una gran capacidad de corte y una vida útil más larga
- Gran resistencia al desgaste y al stress por torsión



Broca no apta para taladrar metales

Code	Ø mm	L mm	P.V.P. unid. €	
122003	3	70	1,47	10
122004	4	75	1,56	10
122005	5	85	1,66	10
122006	6	100	2,10	10
122036	6	200	3,20	5
122046	6	400	6,24	1
122007	7	100	2,18	10
122008	8	120	3,00	10
122038	8	200	3,67	5
122048	8	400	6,58	1
122009	9	120	3,02	5
122010	10	120	3,25	10
122040	10	200	5,26	5
122050	10	400	8,97	1
122011	11	150	4,64	5
122012	12	150	5,00	5
122052	12	400	11,36	1
122013	13	150	6,49	5
122014	14	150	6,97	5
122054	14	400	13,64	1
122015	15	150	8,45	1
122016	16	150	8,65	1
122056	16	400	16,83	1
122018	18	160	10,89	1
122058	18	400	19,24	1
122020	20	160	12,73	1
122060	20	400	22,65	1
122022	22	160	15,44	1
122062	22	400	26,36	1

Se suministra con colgador

## Broca SDS-Plus para hormigón



### UTILIZACION:

- Hormigón
- Ladrillo
- Piedra
- Baldosa
- Mármol
- Granito
- Pizarra

- Fabricada en Acero aleado y templado entre 42÷50 HRC
- Hélice de 4 canales. Evacuación más eficaz del polvo. Mayor velocidad de taladrado y vida útil más larga. Gran resistencia al desgaste y stress por torsión
- Punta de Carburo de Tungsteno (gran capacidad de corte)
- Acabado Granallado fino y aceite anti-oxidación
- Broca preparada para trabajos de percusión



Broca no apta para taladrar metales

Code	Ø mm	L mm	P.V.P. unid. €	
122104	4	110	3,97	5
122105	5	110	3,97	5
122106	6	110	3,97	5
122126	6	210	6,74	1
122146	6	260	10,23	1
122107	7	110	5,07	5
122108	8	110	5,07	5
122128	8	210	6,43	1
122148	8	260	9,30	1
122109	9	110	5,29	5
122110	10	110	5,56	5
122130	10	210	7,87	1
122150	10	260	9,94	1
122111	11	160	7,23	1
122112	12	160	7,28	1
122132	12	210	8,83	1
122152	12	260	10,65	1
122113	13	160	11,51	1
122114	14	160	11,77	1
122134	14	210	12,96	1
122154	14	260	14,70	1
122115	15	160	13,25	1
122116	16	160	13,36	1
122136	16	210	16,23	1
122156	16	260	18,01	1
122117	17	210	21,80	1
122118	18	210	21,87	1
122119	19	210	23,73	1
122120	20	210	23,99	1

Se suministra con colgador

**Juego de brocas para hormigón**



COMPOSICION 5x110, 6x110, 8x110, 10x110 mm			
Code	Nº piezas	P.V.P. unid. €	
<b>122170</b>	4	<b>20,00</b>	1



COMPOSICION 5x110, 6x110, 8x110, 8x160, 10x160, 12x160 mm			
Code	Nº piezas	P.V.P. unid. €	
<b>122180</b>	6	<b>32,93</b>	1

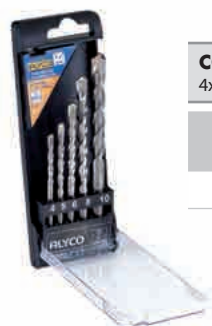

COMPOSICION 4x75, 5x85, 6x100, 8x120, 10x120 mm			
Code	Nº piezas	P.V.P. unid. €	
<b>122070</b>	5	<b>12,00</b>	1



COMPOSICION 3x70, 4x75, 5x85, 6x100, 7x100, 8x120, 9x120, 10x120 mm			
Code	Nº piezas	P.V.P. unid. €	
<b>122080</b>	8	<b>18,50</b>	1

**Broca helicoidal para madera y plástico**

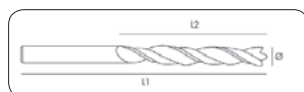

Code	Ø mm	P.V.P. unid. €	
<b>136001</b>	3	<b>2,29</b>	12
<b>136002</b>	4	<b>2,32</b>	12
<b>136003</b>	5	<b>2,48</b>	12
<b>136004</b>	6	<b>2,49</b>	12
<b>136005</b>	7	<b>2,75</b>	12
<b>136006</b>	8	<b>2,80</b>	12
<b>136007</b>	9	<b>3,49</b>	12
<b>136008</b>	10	<b>3,68</b>	12
<b>136009</b>	11	<b>4,30</b>	12
<b>136010</b>	12	<b>5,31</b>	12
<b>136011</b>	13	<b>5,93</b>	12
<b>136012</b>	14	<b>7,41</b>	12
<b>136013</b>	15	<b>9,46</b>	12
<b>136014</b>	16	<b>11,36</b>	12

**Juegos de brocas para madera y plástico**



COMPOSICION 4, 5, 6, 8, 10 mm			
Code	Nº piezas	P.V.P. unid. €	
<b>136205</b>	5	<b>11,71</b>	1



COMPOSICION 3, 4, 5, 6, 7, 8, 9, 10 mm			
Code	Nº piezas	P.V.P. unid. €	
<b>136208</b>	8	<b>14,00</b>	1

## Broca plana



Sistema de amarre con ranura de acoplamiento rápido en el mango



Code	Ø mm	P.V.P. unid. €		Code	Ø mm	P.V.P. unid. €		Code	Ø mm	P.V.P. unid. €	
135011	6	3,33	12	135004	19	4,85	12	135008	30	6,22	12
135012	8	4,36	12	135016	20	5,13	12	135009	32	6,28	12
135001	10	4,62	12	135005	22	5,22	12	135019	34	6,60	12
135002	12	4,64	12	135017	24	5,25	12	135010	35	6,72	12
135013	14	4,80	12	135006	25	5,28	12	135020	36	6,73	12
135003	16	4,81	12	135018	26	5,30	12	135021	38	6,94	12
135014	17	4,82	12	135007	28	6,18	12	135022	40	6,95	12
135015	18	4,83	12								

Se suministra con colgador

## Juego de brocas planas



135070



135080

### COMPOSICION

**135070** 10, 12, 16, 19, 22, 25 mm  
**135080** 8, 10, 12, 14, 16, 19, 20, 22, 25, 30, 32, 35, 38 mm + alargadera + llave Allen

Code	Nº piezas	P.V.P. unid. €	
135070	6	24,76	1
135080	15	53,26	1

## Alargadera para brocas planas



• Longitud total de broca + alargadera: 450 mm

Code	L mm	P.V.P. unid. €	
135051	300	11,91	6

## Fresa para bisagras



• Fresas con plaquitas de widia soldadas

Code	Ø mm	L mm	P.V.P. unid. €	
138010	15	90	8,34	6
138011	20	90	11,85	6
138001	26	90	13,76	6
138002	30	90	15,29	6
138003	35	90	16,93	6
138012	40	90	20,53	6
138013	45	90	23,37	6
138014	50	90	25,35	6

**Barreno salomónico, mango hexagonal**



**LONGITUD 400 MM**



Hélice rectificada de 300 mm



SISTEMA DE AMARRE:  
- Hexágono de 1/2"  
- Ranura de acoplamiento rápido con Hta. neumática y eléctrica

- Con doble filo de corte
- Hélice de doble entrada para mayor capacidad de corte
- Guía roscada en la punta
- Filos de corte rectificadas

Code	Ø mm	P.V.P. unid. €	
<b>131110</b>	10	<b>19,28</b>	6
<b>131112</b>	12	<b>19,86</b>	6
<b>131114</b>	14	<b>21,00</b>	6
<b>131116</b>	16	<b>23,29</b>	6
<b>131117</b>	17	<b>24,29</b>	6
<b>131118</b>	18	<b>25,55</b>	6
<b>131120</b>	20	<b>26,27</b>	6

**Barreno salomónico, ojo de barril**

**LONGITUD 400 MM  
DOBLE FILO DE CORTE**



**Empleo para encofrados y traviesas de vías férreas**

Code	Ø mm	P.V.P. unid. €	
<b>131002</b>	8	<b>18,97</b>	6
<b>131004</b>	10	<b>20,05</b>	6
<b>131006</b>	12	<b>20,64</b>	6
<b>131008</b>	14	<b>21,83</b>	6
<b>131010</b>	16	<b>25,00</b>	6
<b>131011</b>	17	<b>27,50</b>	6
<b>131012</b>	18	<b>28,50</b>	6
<b>131014</b>	20	<b>31,00</b>	6
<b>131016</b>	22	<b>34,00</b>	6
<b>131018</b>	24	<b>35,00</b>	6
<b>131020</b>	26	<b>36,00</b>	6
<b>131022</b>	28	<b>39,00</b>	6
<b>131024</b>	30	<b>40,00</b>	6

**Barrena para máquina**

**DOBLE FILO DE CORTE**



**Empleo para el taladrado de traviesas de vías férreas**

Code	Ø mm	L mm	P.V.P. unid. €	
<b>131031</b>	16	285	<b>28,11</b>	10
<b>131032</b>	17	285	<b>30,19</b>	10
<b>131033</b>	18	285	<b>31,37</b>	10
<b>132009</b>	17	224	<b>28,12</b>	10

**Taladro de pecho**



Code	Ø mm	P.V.P. unid. €	
<b>151001</b>	0-13	<b>48,83</b>	1



## 10 Jardinería



Tijera de poda

207



Tijera de vendimia

208



Tijera de dos manos

209



Serrucho de poda

210



### Tijera de poda mango giratorio

ACERO  
SK5



Poda



Recoleccion



25 mm

Capacidad de corte



30%

Reduce la fatiga y el esfuerzo

Code	L mm	L "	P.V.P. unid. €	
<b>108420</b>	220	9	<b>26,20</b>	10

Se suministra en blister  
Repuestos de hoja, contrahoja y muelle disponibles

### Tijera de poda mangos aluminio

ACERO  
SK5



Poda



Recoleccion



25 mm

Capacidad de corte



- Cuerpo en Aluminio forjado
- Muelle de apertura automática
- Mangos ergonómicos antideslizantes
- Cierre de seguridad

Code	L mm	L "	P.V.P. unid. €	
<b>108415</b>	220	9	<b>16,40</b>	10

Se suministra en blister  
Repuestos de hoja, contrahoja y muelle disponibles

### Tijera de poda mangos de acero

ACERO  
SK5



Poda



Recoleccion



22 mm

Capacidad de corte



- Mangos fabricado en Acero
- Muelle de apertura automática
- Mangos ergonómicos antideslizantes
- Cierre de seguridad

Code	L mm	L "	P.V.P. unid. €	
<b>108425</b>	220	9	<b>13,20</b>	10

Se suministra en blister

## Tijera de poda forjada

ACERO FORJADO



TIJERA FORJADA



Capacidad de corte  
108400



Capacidad de corte  
108405



- Filos de corte templados
- Corte fácil y limpio by-pass
- Muelle de apertura automática
- Con cierre de seguridad

Code	L mm	L "	P.V.P. unid. €	
<b>108400</b>	180	7	<b>7,20</b>	6
<b>108405</b>	220	8,5	<b>8,82</b>	6

Se suministra en blister

## Tijera de vendimia y recolección

ACERO SK5



Capacidad de corte



- Cuchillas de corte pavonadas
- Muelle de apertura automática
- Mangos ergonómicos en plástico ABS
- Cierre de seguridad

Code	L mm	L "	P.V.P. unid. €	
<b>108410</b>	180	7	<b>5,80</b>	10

Se suministra en blister

## Afilador



Afilado



Aceitado



- Filo de carburo de tungsteno
- Cuerpo de plástico
- Para afilar todo tipo de tijeras y cuchillos

Code	L mm	P.V.P. unid. €	
<b>108492</b>	200	<b>9,80</b>	10

Se suministra en blister

## Afilador basto



Afilado



Aceitado



ESPECIAL DESBASTES



- Filo de carburo de tungsteno
- Cuerpo de plástico
- Para afilar todo tipo de tijeras y cuchillos

Code	L mm	P.V.P. unid. €	
<b>108490</b>	120	<b>9,40</b>	10

Se suministra en blister

**Tijera de 2 manos de poda**



Poda



**35 mm**  
Capacidad de corte

Mangos ergonómicos antideslizantes

Mangos de tubo de aluminio muy ligeros

Cuchilla superior teflonada. Inferior cromada



Con topes de seguridad

Code	L mm	L "	P.V.P. unid. €	
<b>108520</b>	680	27	<b>24,20</b>	1

Repuestos de hoja, contrahoja, mangos y topes de goma disponibles

**Tijera de 2 manos extensible**



Poda



**35 mm**  
Capacidad de corte



Sin extender 680 mm



Cierre para bloqueo de extensión de mangos

Mismas características que 108520

Code	L mm	L "	P.V.P. unid. €	
<b>108525</b>	680-970	27-39	<b>28,70</b>	1

Repuestos de hoja, contrahoja, mangos y topes de goma disponibles

**Tijera de 2 manos articulada**



Poda



**45 mm**  
Capacidad de corte

Mangos de tubo de aluminio muy ligeros



Cabeza articulada

- Mangos ergonómicos antideslizantes
- Cuchilla teflonada. Sufridera de aluminio

Code	L mm	L "	P.V.P. unid. €	
<b>108530</b>	820	33	<b>29,30</b>	1

## Tijera cortasetos

HOJA DE 210 MM  
FILOS TEFLONADOS



Mangos ergonómicos  
antideslizantes

Mangos de tubo de  
aluminio muy ligeros

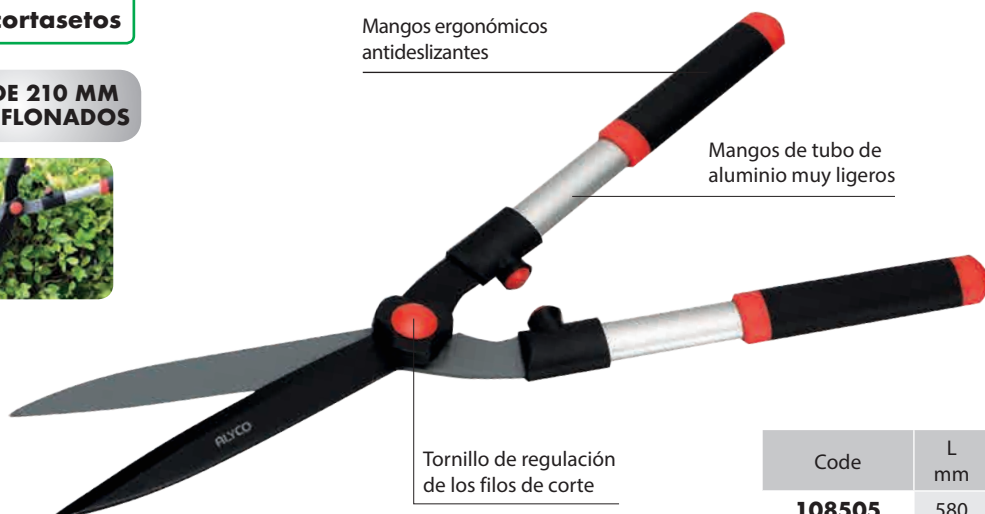

Tornillo de regulación  
de los filos de corte



Con tope  
de seguridad

Code	L mm	L "	P.V.P. unid. €	
<b>108505</b>	580	23	<b>22,30</b>	1

## Tijera cortasetos extensible

EXTENSIBLE

660 mm  
860 mm



Sin extender 660 mm



Cierre para bloqueo  
de extensión de  
mangos

Mismas características que 108505

Code	L mm	L "	P.V.P. unid. €	
<b>108510</b>	660-860	26-34	<b>29,00</b>	1

## Serrucho de poda

HOJA DE 330 MM

DENTADO JAPONES

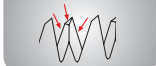

• Funda de plástico para cinturón incluida

Code	L mm	L "	P.V.P. unid. €	
<b>144092</b>	480	19	<b>12,00</b>	12

## Serrucho abatible de poda

HOJA DE 180 MM



• Serrucho abatible con cierre de seguridad  
• Mango bimataterial ergonómico

Code	L abierto mm	L cerrado mm	P.V.P. unid. €	
<b>144097</b>	400	240	<b>9,00</b>	6

**Paletín de jardinería**



Code	Medida mm	P.V.P. unid. €	
<b>108550</b>	350 x 80	<b>4,40</b>	12

**Rastrillo de jardinería**



Code	Medida mm	P.V.P. unid. €	
<b>108555</b>	325 x 80	<b>5,00</b>	12

**Azada-rastrillo de jardinería**

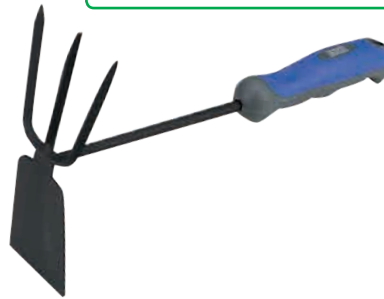

Code	Medida mm	P.V.P. unid. €	
<b>108560</b>	325 x 80 x 75	<b>4,40</b>	12

**Escoba metálica**



• Escoba en Acero

Code	Nº puas	Medida mm	P.V.P. unid. €	
<b>198518</b>	22	425 x 400	<b>4,37</b>	6

Se suministra sin mango

**Escoba de PVC**



• Escoba en PVC

Code	Nº puas	Medida mm	P.V.P. unid. €	
<b>198520</b>	22	480 x 430	<b>6,00</b>	6

Se suministra sin mango

**Mangos para escobas**

Imagen	Code	Para Code	Tipo	L mm	Ø mm	P.V.P. unid. €	
	<b>198519</b>	198518	Recto	1200	24	<b>3,75</b>	6
	<b>198521</b>	198520	Recto	1200	24	<b>4,00</b>	6

**Bolsa de nylon para tijeras**



Posibilidad de sujeción al bolsillo y al cinturón

Code	Medida mm	P.V.P. unid. €	
<b>196848</b>	220 X 90	<b>4,50</b>	1



## 11 Construcción



**Pala de Acero** 213



**Pala de Aluminio** 214



**Pala de Plástico** 214



**Raedera** 215



**Rastrillo** 216



**Plomada** 217

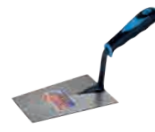

**Paleta** 218

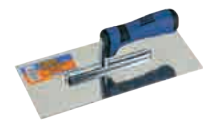

**Llana** 221



**Talocha** 222



**Espátula** 224



**Barra de desencofrar** 225



**Carraca de andamio** 225



**Tornillo de apriete** 226



**Sargento de plástico** 227



**Pinza** 227



**Bolsa porta herramientas** 228

**Pala punta, mango muleta**



Mango en T

198604 mango recto

Ver mangos en pág. 215

Code	Medida mm	L mm	P.V.P. unid. €	
<b>198600</b>	280x340	1000	<b>14,00</b>	6
<b>198604</b>	280x340	1200	<b>15,00</b>	6 <b>Nuevo</b>

**Pala punta, mango anilla**



Mango en Anilla

Ver mangos en pág. 215

Code	Medida mm	L mm	P.V.P. unid. €	
<b>198610</b>	280x340	1000	<b>15,00</b>	6

**Pala cuadrada, mango muleta**



Mango en T

Ver mangos en pág. 215

Code	Medida mm	L mm	P.V.P. unid. €	
<b>198605</b>	280x340	1000	<b>14,10</b>	6

**Pala cuadrada, mango anilla**



Mango en Anilla

Ver mangos en pág. 215

Code	Medida mm	L mm	P.V.P. unid. €	
<b>198615</b>	280x340	1000	<b>15,10</b>	6

**Pala punta, mango fibra de vidrio**



Mango en anilla

Ver mangos en pág. 215

Code	Medida mm	L mm	P.V.P. unid. €	
<b>198613</b>	280x340	1000	<b>20,00</b>	6

**Palote, mango madera**

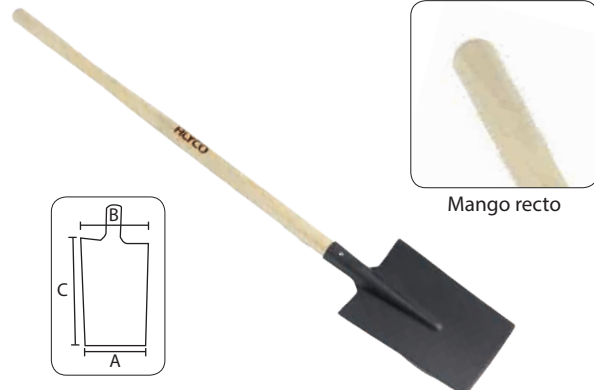

Mango recto

Code	Medida AxBxC mm	L mm	P.V.P. unid. €	
<b>198603</b>	158x192x255	1220	<b>12,00</b>	6

**Palas: Lote de envío 6 unidades ó múltiplos**

## Minipala punta, mango de madera



Mango en Anilla

**25 % MAS CORTA**

Code	Medida mm	L mm	P.V.P. unid. €	
<b>198614</b>	150x210	750	<b>9,00</b>	6

## Pala de aluminio, mango de madera



Mango en Anilla

**Empleo en nieve, alimentación...**



Mango en Anilla

- Pala fabricada en Aluminio
- Mango con anilla fabricada en plástico duro

Code	Medida mm	L mm	P.V.P. unid. €	
<b>198617</b>	245x300	1000	<b>19,00</b>	6

- Pala fabricada en Aluminio
- Mango con anilla fabricada en plástico duro

Code	Medida mm	L mm	P.V.P. unid. €	
<b>198619</b>	360x415	1200	<b>27,00</b>	6

## Pala de aluminio, mango de fibra



Mango en Anilla

**ANTI CORROSIÓN**

**ALIMENTACIÓN**

- Pala fabricada en Aluminio
- Mango fabricado en fibra de vidrio

Code	Medida mm	L mm	P.V.P. unid. €	
<b>198621</b>	360x415	1020	<b>32,00</b>	6

## Pala de plástico



Mango en Anilla

**ANTI CORROSIÓN**

**ALIMENTACIÓN**

- Pala fabricada en plástico
- Mango fabricado en fibra de vidrio

Code	Medida mm	L mm	P.V.P. unid. €	
<b>198622</b>	460x360	1250	<b>21,00</b>	6

**Palas: Lote de envío 6 unidades ó múltiplos**



## Mango para pala

Imagen	Code	Para Código	Tipo	L mm	P.V.P. unid. €	
	<b>198601</b>	198600 / 198605	Muleta	700	<b>8,00</b>	6
	<b>198611</b>	198610 / 198615 198617	Anilla	700	<b>9,00</b>	6
	<b>198602</b>	198600 / 198605	Muleta	815	<b>10,00</b>	6
	<b>198612</b>	198610 / 198615 198617 / 198613 198621	Anilla	735	<b>13,00</b>	6

## Raedera semicircular

ACERO CARBONO



## Raedera rectangular

ACERO CARBONO



• Con soldadura pala mango

Mangos acoplables: 198501/ 198503

Code	Medida mm	P.V.P. unid. €	
<b>198500</b>	260x160	<b>12,00</b>	12

Mangos acoplables: 198501/ 198503

Code	Medida mm	P.V.P. unid. €	
<b>198502</b>	310x138	<b>12,10</b>	12

## Rastrillo 5 púas forjado

ACERO CARBONO



Mangos acoplables: 198506/ 198507

Code	Medida mm	P.V.P. unid. €	
<b>198505</b>	200x160	<b>17,26</b>	6

## Legón

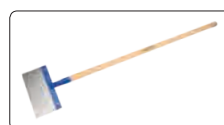

**Nuevo**

Mango acoplable: 198529 (pág. 216)

Code	Medida mm	P.V.P. unid. €	
<b>198530</b>	300x150	<b>7,90</b>	6

## Mango para raedera, rastrillo y azada



198501 / 198503 para raederas 198500 y 198502 y legón 198530  
198506 / 198507 para rastrillo 198505 y azadas  
198508 para azadas

Code	Tipo	Ø mm	L mm	P.V.P. unid. €	
<b>198501</b>	<b>MADERA</b>	37	1200	<b>7,00</b>	6
<b>198506</b>	<b>MADERA</b>	40	1000	<b>7,20</b>	6
<b>Nuevo 198508</b>	<b>MADERA</b>	38	1000	<b>8,50</b>	6
<b>198503</b>	<b>FIBRA VIDRIO</b>	37	1200	<b>16,50</b>	6
<b>198507</b>	<b>FIBRA VIDRIO</b>	40	1000	<b>15,00</b>	6

## Rastrillo

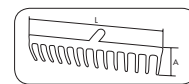
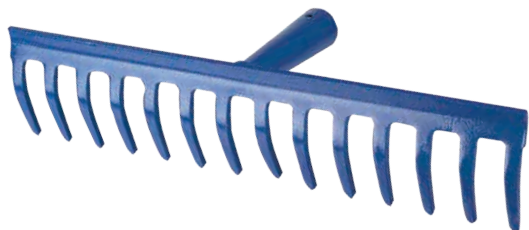

Mango acoplable: 198510, ver a pie de página

Code	Nº puas	A x L mm	P.V.P. unid. €	
<b>198512</b>	12	100 x 410	<b>7,39</b>	6
<b>198514</b>	14	100 x 470	<b>7,80</b>	6
<b>198516</b>	16	100 x 530	<b>8,22</b>	6

## Horca

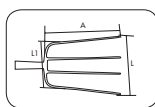

Mangos acoplables: 198527/ 198529, ver a pie de página

Code	Nº puas	A x L x L1 mm	P.V.P. unid. €	
<b>198524</b>	4	327x215x190	<b>10,97</b>	6
<b>198525</b>	5	337x217x195	<b>14,79</b>	6
<b>198526</b>	6	350x245x225	<b>16,60</b>	6

## Garabato

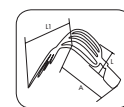

Mango acoplable: 198539, ver a pie de página

Code	Nº puas	A x L x L1 mm	P.V.P. unid. €	
<b>198534</b>	4	200x205x210	<b>9,66</b>	6
<b>198535</b>	5	200x220x220	<b>13,36</b>	6

## Horca recta de cavar

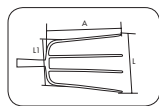

Mango acoplable: 198558, ver a pie de página

Code	Nº puas	A x L mm	P.V.P. unid. €	
<b>198544</b>	4	280x175	<b>12,89</b>	6

## Horca para piedra y grava

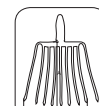

Mango acoplable: 198558, ver a pie de página

Code	Nº puas	A x L mm	P.V.P. unid. €	
<b>198550</b>	9	360x240	<b>19,56</b>	6

## Mango para rastrillo y horca

Imagen	Code	Para Code	Tipo	L mm	Ø mm	P.V.P. unid. €	
	<b>198510</b>	198512/198514/198516	Recto	1200	28	<b>5,01</b>	6
	<b>198527</b>	198524/198525/198526	Anilla	960	37	<b>8,50</b>	6
	<b>198529</b>	198524/198525 198526/198530	Recto	1200	37	<b>6,91</b>	6
	<b>198539</b>	198534/198535	Recto	1200	37	<b>6,91</b>	6
	<b>198558</b>	198544/198550	Anilla	960	37	<b>9,00</b>	6

**Plomada magnética**

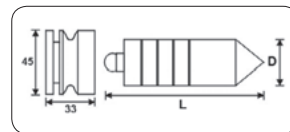

- Plomada y tornillo fabricados en Acero  
Terminación en zincado para evitar la corrosión
- Nuez de plástico con inserción de imán
- Cuerda trenzada de nylon de 5 metros

Code	Peso gr	L mm	Ø mm	P.V.P. unid. €	
<b>197942</b>	500	104	33	<b>13,20</b>	5
<b>197944</b>	750	134	33	<b>15,00</b>	5
<b>197946</b>	1000	162	33	<b>16,50</b>	5

Se suministra en blister

**Plomada nuez de madera**

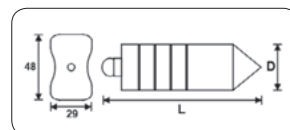

- Plomada y tornillo fabricados en Acero  
Terminación en zincado para evitar la corrosión
- Nuez fabricada en madera
- Cuerda trenzada de nylon de 5 metros

Code	Peso gr	L mm	Ø mm	P.V.P. unid. €	
<b>197932</b>	500	104	33	<b>7,20</b>	5
<b>197934</b>	750	134	33	<b>9,25</b>	5
<b>197936</b>	1000	162	33	<b>12,10</b>	5

Se suministra en blister

**Ángulo magnético**



- Ángulo con potentes imanes
- Cuerda de Ø 1,2 mm
- Ángulo con asa de goma

**COMPOSICION**

- 2 ángulos con imán
- Cuerda de 10 metros

Code	P.V.P. unid. €	
<b>197938</b>	<b>15,00</b>	6

Se suministra en blister

## Paleta forjada

**HOJA Y MANGO FORJADOS DE UNA SOLA PIEZA**

## Paleta forjada tipo Norte



## Paleta forjada tipo Madrid



## Paleta forjada tipo Catalana



## Paleta forjada tipo Sevilla



- Hoja barnizada para evitar la oxidación
- Hoja rectificada cónicamente por ambos lados para una flexión adecuada
- Hoja y espiga tratadas térmicamente

### MANGO MADERA

Code	Medida mm	P.V.P. unid. €	
<b>195900</b>	180x115	<b>12,56</b>	6
<b>195905</b>	190x118	<b>13,13</b>	6

### MANGO BIMATERIAL

Code	Medida mm	P.V.P. unid. €	
<b>195901</b>	180x115	<b>13,48</b>	6
<b>195906</b>	190x118	<b>14,09</b>	6



### MANGO MADERA

Code	Medida mm	P.V.P. unid. €	
<b>195910</b>	190x104	<b>10,90</b>	6
<b>195915</b>	215x116	<b>11,43</b>	6

### MANGO BIMATERIAL

Code	Medida mm	P.V.P. unid. €	
<b>195911</b>	190x104	<b>12,21</b>	6
<b>195916</b>	215x116	<b>12,67</b>	6



### MANGO MADERA

Code	Medida mm	P.V.P. unid. €	
<b>195920</b>	150x115	<b>12,34</b>	6
<b>195925</b>	160x120	<b>12,92</b>	6

### MANGO BIMATERIAL

Code	Medida mm	P.V.P. unid. €	
<b>195921</b>	150x115	<b>13,63</b>	6
<b>195926</b>	160x120	<b>14,16</b>	6



### MANGO MADERA

Code	Medida mm	P.V.P. unid. €	
<b>195930</b>	190x115	<b>13,20</b>	6

### MANGO BIMATERIAL

Code	Medida mm	P.V.P. unid. €	
<b>195931</b>	190x115	<b>14,37</b>	6



**Paleta soldada**

**HOJA Y MANGO UNIDOS  
POR SOLDADURA**

- Hoja barnizada para evitar la oxidación
- Hoja rectificada cónicamente por ambos lados para una flexión adecuada
- Hoja y espiga tratadas térmicamente

**Paleta soldada tipo Norte**



MANGO MADERA			
Code	Medida mm	P.V.P. unid. €	
<b>195700</b>	180x115x87	<b>6,21</b>	12
<b>195705</b>	190x118x90	<b>6,71</b>	12

MANGO BIMATERIAL			
Code	Medida mm	P.V.P. unid. €	
<b>195701</b>	180x115x87	<b>7,48</b>	12
<b>195706</b>	190x118x90	<b>7,86</b>	12



**Paleta soldada tipo Madrid**



MANGO MADERA			
Code	Medida mm	P.V.P. unid. €	
<b>195708</b>	140x80	<b>4,41</b>	12
<b>195710</b>	178x98	<b>5,38</b>	12
<b>195715</b>	200x110	<b>5,63</b>	12
<b>195717</b>	220x125	<b>6,00</b>	12

MANGO BIMATERIAL			
Code	Medida mm	P.V.P. unid. €	
<b>195709</b>	140x80	<b>5,75</b>	12
<b>195711</b>	178x98	<b>6,81</b>	12
<b>195716</b>	200x110	<b>7,08</b>	12
<b>195718</b>	220x125	<b>7,44</b>	12



**Paleta soldada tipo Catalana**



MANGO MADERA			
Code	Medida mm	P.V.P. unid. €	
<b>195720</b>	155x115	<b>6,19</b>	12
<b>195725</b>	170x120	<b>6,32</b>	12
<b>195723</b>	180x125	<b>6,54</b>	12

MANGO BIMATERIAL			
Code	Medida mm	P.V.P. unid. €	
<b>195721</b>	155x115	<b>7,05</b>	12
<b>195726</b>	170x120	<b>7,18</b>	12
<b>195724</b>	180x125	<b>7,44</b>	12



## Paleta soldada tipo Sevilla



### MANGO MADERA

Code	Medida mm	P.V.P. unid. €	
<b>195730</b>	190x115x90	<b>6,49</b>	12

### MANGO BIMATERIAL

Code	Medida mm	P.V.P. unid. €	
<b>195731</b>	190x115x90	<b>7,50</b>	12



## Paletín soldado de punta



### MANGO MADERA

Code	Medida mm	P.V.P. unid. €	
<b>195740</b>	130x75	<b>4,52</b>	12

### MANGO BIMATERIAL

Code	Medida mm	P.V.P. unid. €	
<b>195741</b>	130x75	<b>5,93</b>	12



## Paletín soldado de punta redonda



### MANGO MADERA

Code	Medida mm	P.V.P. unid. €	
<b>195750</b>	125x70	<b>4,41</b>	12

### MANGO BIMATERIAL

Code	Medida mm	P.V.P. unid. €	
<b>195751</b>	125x70	<b>5,85</b>	12



## Paletín soldado hoja de olivo



### MANGO MADERA

Code	Medida mm	P.V.P. unid. €	
<b>195760</b>	130x70	<b>4,22</b>	12

### MANGO BIMATERIAL

Code	Medida mm	P.V.P. unid. €	
<b>195761</b>	130x70	<b>5,62</b>	12



## Paleta para juntas mango de madera



Code	L mm	C mm	P.V.P. unid. €	
<b>195804</b>	180	8	<b>2,50</b>	12
<b>195806</b>	180	10	<b>2,60</b>	12

## Llana rectangular, mango bimaterial

ACERO  
INOX



Base lisa sin tornillos

Code	Medida mm	P.V.P. unid. €	
<b>195772</b>	280x215	<b>11,12</b>	10

## Llana rectangular, mango madera

ACERO  
INOX



Base lisa sin tornillos

Code	Medida mm	P.V.P. unid. €	
<b>195770</b>	300x150	<b>10,76</b>	6

## Llana rectangular afilada

ACERO  
INOX



Cantos afilados



Base lisa sin tornillos

Code	Medida mm	P.V.P. unid. €	
<b>195768</b>	300x150	<b>11,96</b>	6

## Llana rectangular trapezoidal

ACERO  
INOX



Base lisa sin tornillos

Code	Medida mm	P.V.P. unid. €	
<b>195780</b>	300x140-150	<b>10,76</b>	6

## Llana almenada

ACERO  
INOX



Code	Medida mm	paso	P.V.P. unid. €	
<b>195785</b>	280x120	6x6	<b>11,07</b>	6
<b>195786</b>	280x120	8x8	<b>11,65</b>	6
<b>195787</b>	280x120	10x10	<b>12,22</b>	6

## Llana media luna

ACERO  
INOX



Code	Medida mm	P.V.P. unid. €	
<b>195774</b>	300x150	<b>10,76</b>	6

## Llana para yesero

ACERO  
INOX



Code	Medida mm	P.V.P. unid. €	
<b>195775</b>	500x130	<b>14,03</b>	6

## Llana almenada para yesero

ACERO  
INOX



Code	Medida mm	∟ paso	P.V.P. unid. €	
<b>195776</b>	500x130	8x8	<b>15,28</b>	6

## Rascador monocapa

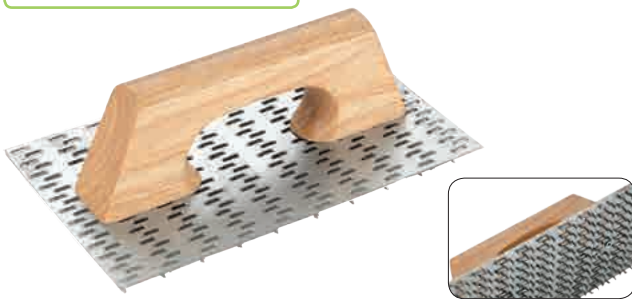

Code	Medida mm	P.V.P. unid. €	
<b>195762</b>	250x140	<b>13,67</b>	6

## Guía de aluminio para yesero



Code	Medida mm	P.V.P. unid. €	
<b>195764</b>	450x80	<b>22,50</b>	1

## Talocha de plástico rectangular



• Base fabricada en poliestireno

Code	Medida mm	P.V.P. unid. €	
<b>195790</b>	270x180	<b>3,50</b>	6

## Talocha de plástico de punta



• Base fabricada en poliestireno

Code	Medida mm	P.V.P. unid. €	
<b>195792</b>	270x180	<b>3,55</b>	6

## Talocha de goma para juntas



## Empleo en trabajos de juntas



• Mango fabricado en poliuretano  
• Refuerzo de aluminio en la base

Code	Medida mm	P.V.P. unid. €	
<b>195800</b>	240x100	<b>8,00</b>	6



**Talocha de goma-esponja**



Agujeros esponja de mayor diámetro que 195796

- Base 20 mm de espesor
- Mango y base fabricados en poliuretano

Code	Medida mm	P.V.P. unid. €	
<b>195795</b>	280x140	<b>8,30</b>	6

**Talocha de goma-esponja densa**



Agujeros esponja de menor diámetro que 195795

Code	Medida mm	P.V.P. unid. €	
<b>195796</b>	280x140	<b>8,40</b>	6

**Talocha de esponja baja densidad**



Code	Medida mm	P.V.P. unid. €	
<b>195788</b>	240x140	<b>6,50</b>	6

**Espátula de emplastecer, mango tricomponente**

ACERO INOX

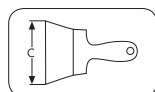

Code	C mm	P.V.P. unid. €	
<b>196306</b>	120	<b>6,01</b>	6
<b>196311</b>	140	<b>6,20</b>	6
<b>196316</b>	160	<b>6,62</b>	6
<b>196318</b>	180	<b>7,22</b>	6
<b>196321</b>	200	<b>8,69</b>	6

**Espátula de emplastecer, mango madera**

ACERO INOX

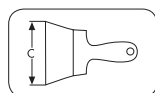

Code	C mm	P.V.P. unid. €	
<b>196305</b>	120	<b>3,72</b>	12
<b>196310</b>	140	<b>4,18</b>	12
<b>196315</b>	160	<b>4,96</b>	12
<b>196320</b>	200	<b>5,79</b>	12

**Juego espátulas para carrocero**

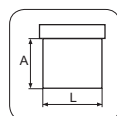

**COMPOSICION**

- 1 Espátula de L: 50 A: 90
- 1 Espátula de L: 75 A: 90
- 1 Espátula de L: 100 A: 90
- 1 Espátula de L: 120 A: 95

Code	Nº piezas	P.V.P. unid. €	
<b>196322</b>	4	<b>3,80</b>	10

## Espátula inoxidable

ACERO  
INOX



Refuerzo metálico para poder golpear

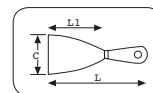

- Hoja rectificada cónicamente para flexionar la punta
- Cuerpo del mango en plástico de gran resistencia
- Mango recubierto de elastómero antideslizante

Code	C mm	L mm	P.V.P. unid. €	
<b>196399</b>	30	210	<b>3,77</b>	12
<b>196401</b>	40	220	<b>3,82</b>	12
<b>196403</b>	50	220	<b>4,00</b>	12
<b>196406</b>	60	220	<b>4,19</b>	12
<b>196411</b>	80	220	<b>4,86</b>	12
<b>196416</b>	100	220	<b>5,36</b>	12
<b>196421</b>	120	230	<b>6,16</b>	12
<b>196423</b>	150	230	<b>7,39</b>	12

## Espátula mango de madera

ACERO  
CARBONO

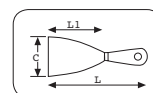

Code	C mm	L mm	P.V.P. unid. €	
<b>196325</b>	25	180	<b>2,53</b>	12
<b>196340</b>	40	190	<b>2,63</b>	12
<b>196350</b>	50	195	<b>2,73</b>	12
<b>196360</b>	60	205	<b>2,78</b>	12
<b>196375</b>	75	215	<b>3,05</b>	12
<b>196385</b>	85	220	<b>3,30</b>	12
<b>196390</b>	100	225	<b>3,55</b>	12
<b>196395</b>	120	230	<b>3,77</b>	12

## Espátula mango bicomponente

ACERO  
CARBONO



- Hoja rectificada cónicamente para flexionar la punta
- Cuerpo del mango en plástico de gran resistencia
- Mango recubierto de goma blanda en zonas de contacto con la mano

Code	C mm	L mm	P.V.P. unid. €	
<b>196430</b>	30	210	<b>3,22</b>	12
<b>196440</b>	40	210	<b>3,35</b>	12
<b>196450</b>	50	210	<b>3,54</b>	12
<b>196460</b>	60	210	<b>3,74</b>	12
<b>196480</b>	80	210	<b>4,12</b>	12
<b>196490</b>	100	220	<b>4,57</b>	12
<b>196495</b>	120	220	<b>5,41</b>	12
<b>196496</b>	150	235	<b>5,98</b>	12

## Expositor para espátulas

**COMPOSICION** 196401 (12), 196406(12), 196411 (12), 196416 (12), 196421 (12)

### EXPOSITOR ESPATULAS INOXIDABLES

Code	Nº piezas	P.V.P. unid. €	
<b>196422</b>	60	<b>290,00</b>	1



**COMPOSICION** 196440 (12), 196460(12), 196480 (12), 196490 (12), 196495 (12)

### EXPOSITOR ESPATULAS BICOMPONENTE

Code	Nº piezas	P.V.P. unid. €	
<b>196499</b>	60	<b>248,00</b>	1

**Barra de desencofrar**

ACERO CARBONO

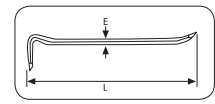

- Extremos de uso templados
- Presentación pintado

Code	L mm	L "	E mm	P.V.P. unid. €	
<b>118001</b>	500	20	20	<b>11,33</b>	10
<b>118002</b>	600	24	20	<b>14,97</b>	10
<b>118003</b>	700	28	20	<b>17,02</b>	10
<b>118004</b>	800	32	22	<b>18,23</b>	5
<b>118005</b>	900	36	22	<b>23,50</b>	5
<b>118006</b>	1000	40	22	<b>25,50</b>	5
<b>118007</b>	1200	48	22	<b>29,50</b>	5

**Palanca desencofrar ligera**

ACERO CARBONO



- Extremos de la palanca templados
- Presentación cromado brillante

Code	L mm	L "	P.V.P. unid. €	
<b>118010</b>	300	12	<b>10,18</b>	10

**Fija de albañil**



Code	L mm	E mm	P.V.P. unid. €	
<b>196942</b>	250	10	<b>4,32</b>	12
<b>196945</b>	300	10	<b>4,56</b>	12

**Llave de carraca para andamios**

ACERO CR-V

19x22

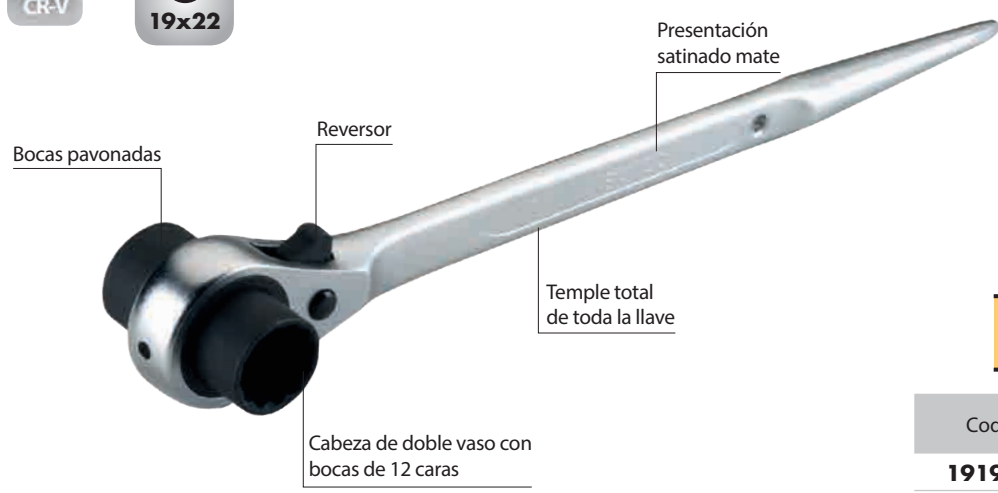

**Empleo en montaje y desmontaje de andamios**

Code	mm	P.V.P. unid. €	
<b>191900</b>	19x22	<b>43,00</b>	2

## Tornillo de apriete con émbolo (90 mm)

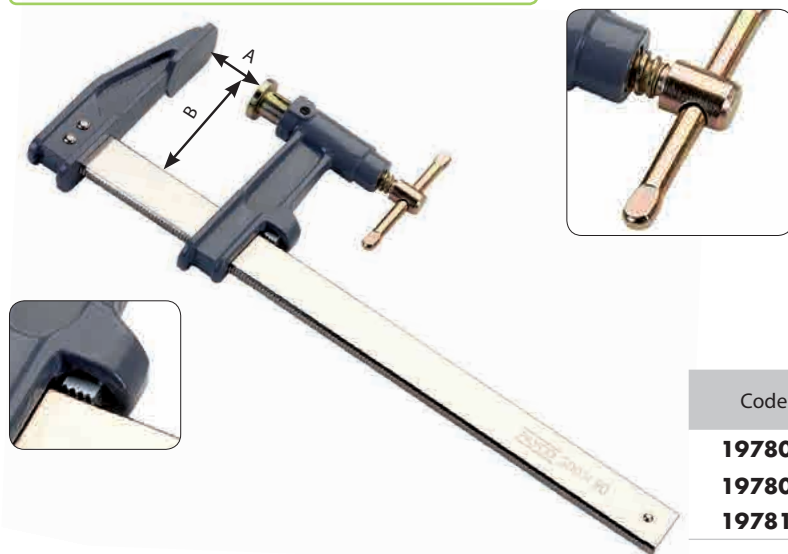

- Mordazas de fundición nodular pintadas
- Fijación de llanta y mordaza con doble remache
- Llanta de acero calibrada y dentada por ambos lados
- Freno dentado y templado
- Embolo de una pieza
- Husillo con doble rosca trapezoidal para grandes aprietes

Code	A mm	B mm	Llanta mm	Fuerza Kg	P.V.P. unid. €	
<b>197800</b>	200	90	28x8	400	<b>14,84</b>	6
<b>197805</b>	300	90	28x8	400	<b>15,85</b>	6
<b>197810</b>	400	90	28x8	400	<b>18,43</b>	6

## Tornillo de apriete con émbolo (120-150 mm)

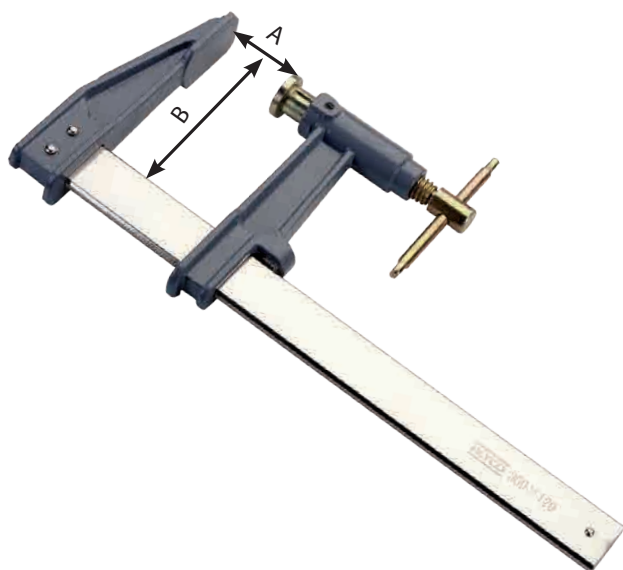

- Mordazas de fundición nodular pintadas
- Fijación de llanta y mordaza con doble remache
- Llanta de acero calibrada y dentada por ambos lados
- Freno dentado y templado
- Embolo de una pieza
- Husillo con doble rosca trapezoidal para grandes aprietes

Code	A mm	B mm	Llanta mm	Fuerza Kg	P.V.P. unid. €	
<b>197850</b>	300	120	35x8	500	<b>18,20</b>	6
<b>197855</b>	400	120	35x8	500	<b>20,88</b>	6
<b>197860</b>	600	120	35x8	500	<b>23,24</b>	4
<b>197865</b>	800	120	35x8	500	<b>26,07</b>	4
<b>197870</b>	1000	120	35x8	500	<b>28,34</b>	2
<b>197872</b>	1200	120	35x8	500	<b>31,49</b>	2
<b>197873</b>	1400	120	35x8	500	<b>37,89</b>	2
<b>197875</b>	400	150	40x10	700	<b>27,76</b>	2
<b>197877</b>	600	150	40x10	700	<b>31,34</b>	2
<b>197880</b>	800	150	40x10	700	<b>35,98</b>	2
<b>197882</b>	1000	150	40x10	700	<b>39,03</b>	2

## Tornillo de apriete con husillo



- Llanta de acero calibrada y dentada por ambos lados
- Mordazas de fundición nodular pintadas
- Mango de plástico bicomponente y ergonómico
- Husillo con rosca trapezoidal
- Bocas con protectores de plástico y platillo pivotante

Code	A mm	B mm	Llanta mm	Fuerza Kg	P.V.P. unid. €	
<b>197900</b>	100	50	5x15	170	<b>5,01</b>	6
<b>197905</b>	150	50	5x15	170	<b>5,24</b>	6
<b>197910</b>	200	80	6x22	270	<b>8,88</b>	6
<b>197915</b>	300	80	6x22	270	<b>9,60</b>	6
<b>197920</b>	400	100	7x22	400	<b>11,91</b>	6

## Tornillo de apriete "C"

ACERO  
FORJADO

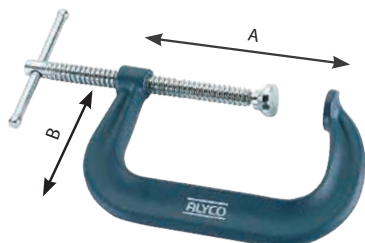

Code	A mm	B mm	Fuerza Kg	P.V.P. unid. €	
<b>197950</b>	50	55	1600	<b>16,43</b>	4
<b>197955</b>	75	55	1600	<b>20,87</b>	4
<b>197960</b>	100	55	1600	<b>26,13</b>	4
<b>197965</b>	150	55	3000	<b>42,17</b>	4

## Sargento automático

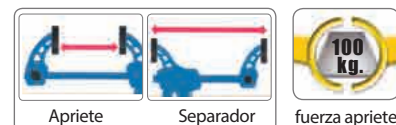

- Palanca de desbloqueo rápido
- Bocas recubiertas de protectores en goma blanda
- Diseño ergonómico. Mangos bimateriales

Code	Apriete mm / "	Separación mm	P.V.P. unid. €	
<b>198050</b>	150 / 6	350	<b>14,31</b>	6
<b>198052</b>	300 / 12	500	<b>14,97</b>	6
<b>198054</b>	450 / 18	640	<b>16,92</b>	6

## Pinza automática con carraca



- Carraca fabricada en aleación de zinc
- Diseño especial de las mordazas para realizar aprietes en piezas con formas irregulares
- Brazos largos y delgados para llegar a zonas de difícil acceso

Code	L mm	Fuerza apriete kg.	P.V.P. unid. €	
<b>198070</b>	135	13	<b>2,89</b>	12
<b>198072</b>	190	30	<b>4,89</b>	12
<b>198074</b>	250	43	<b>7,13</b>	12

## Pinza de plástico



- Muelle interior. Apertura rápida y fácil de la pinza
- Mordazas recubiertas para no dañar y realizar sujeciones de piezas con formas irregulares

Code	L mm / "	Apertura máx. mm	Fuerza Kg	P.V.P. unid. €	
<b>197970</b>	75 / 3	35	3,8	<b>0,91</b>	12
<b>197972</b>	100 / 4	40	9,2	<b>1,31</b>	12
<b>197975</b>	150 / 6	62	13	<b>2,10</b>	12
<b>197976</b>	225 / 9	82	22	<b>2,80</b>	12

## Pinza metálica



- Muelle interior para apertura rápida y fácil de la pinza
- Mangos y bocas recubiertas de PVC

Code	L mm / "	Apertura máx. mm	Fuerza Kg	P.V.P. unid. €	
<b>197982</b>	50 / 2	17	10	<b>1,00</b>	6
<b>197985</b>	100 / 4	22	10	<b>2,06</b>	6
<b>197986</b>	150 / 6	45	15	<b>3,57</b>	6
<b>197987</b>	225 / 9	75	20	<b>5,35</b>	6

## Bolsa doble de nylon



- Fabricada con costuras de refuerzo
- Con cinturón ajustable de cierre rápido

Code	AxB mm	P.V.P. unid. €	
<b>196870</b>	660x260	<b>15,00</b>	1

Se suministra en bolsa con colgador

## Bolsa individual de nylon con cinturón



- Fabricada con costuras de refuerzo
- Con cinturón ajustable de cierre rápido

Code	AxB mm	P.V.P. unid. €	
<b>196875</b>	260x260	<b>9,50</b>	1

Se suministra en bolsa con colgador

## Bolsa doble de cuero



- Fabricado en cuero resistente de alta calidad
- Costuras y remaches metálicos de refuerzo en toda la bolsa
- Cinturón de nylon ajustable
- Clip metálico para cinta métrica
- Bolsillos de gran capacidad para clavos
- 2 lazos para martillos

Code	AxB mm	P.V.P. unid. €	
<b>196890</b>	660x210	<b>27,00</b>	1

Se suministra en bolsa con colgador

## Bolsa individual de cuero con cinturón



- Fabricado en cuero resistente de alta calidad
- Costuras y remaches metálicos de refuerzo en toda la bolsa
- Cinturón de nylon ajustable
- Clip metálico para cinta métrica
- Bolsillos de gran capacidad para clavos

Code	AxB mm	P.V.P. unid. €	
<b>196894</b>	230x210	<b>19,00</b>	1

Se suministra en bolsa con colgador

## Bolsa individual de cuero



- Fabricado en cuero resistente de alta calidad
- Costuras y remaches metálicos de refuerzo
- Bolsillo de gran capacidad para clavos
- 2 lazos para martillos

Code	AxB mm	P.V.P. unid. €	
<b>196895</b>	260x290	<b>18,80</b>	1

Se suministra en bolsa con colgador

## Porta flexómetros



- Posibilidad de utilizar con cinturón
- Válidos para flexómetros de 3 y 5 metros
- Reforzados con remaches metálicos

Code	Tipo	AxB mm	P.V.P. unid. €	
<b>196898</b>	Cuero	110x160	<b>4,42</b>	6
<b>196899</b>	Nylon	110x160	<b>6,00</b>	6

Se suministra en bolsa con colgador

## Porta martillos



- Posibilidad de utilizar con cinturón
- Aro metálico para colocar el martillo
- Aro reforzado con remaches metálicos

Code	Tipo	AxB mm	P.V.P. unid. €	
<b>196896</b>	Cuero	200x120	<b>2,70</b>	6
<b>196886</b>	Nylon	200x120	<b>3,82</b>	6

Se suministra en bolsa con colgador

## Cinturón



196885



196897

- 196885 cinturón de cuero de alta calidad y cierre metálico
- 196897 cinturón de nylon ajustable y cierre metálico

Code	Tipo	L mm	P.V.P. unid. €	
<b>196885</b>	Cuero	1240	<b>12,50</b>	6
<b>196897</b>	Nylon	1240	<b>2,99</b>	6

Se suministra en bolsa con colgador

## Rodillera



## ANTIQUIDOS ANTIPINCHAZOS

**Nuevo**

- Fabricado en nylon Oxford
- Acolchado de 20 mm en EVA y PVC
- Correas de neopreno superflexible
- Costuras reforzadas

Code	Tamaño mm	P.V.P. unid. €	
<b>198142</b>	230x190	<b>19,00</b>	1

## Rodillera



**Nuevo**

- Fabricado en nylon Oxford
- Relleno de 10 mm de EVA
- Correas de neopreno superflexible
- Costuras reforzadas

Code	Tamaño mm	P.V.P. unid. €	
<b>198140</b>	200x170	<b>17,00</b>	1



## 12 Fontanería y medición



Llave para tubo 231



Llave de cadena 233



Llave de cuero 233



Cortatubos PVC 234



Cortatubos 235



Cortatubos para acero 236



Nivel 238



Nivel torpedo 240



Flexómetro 242



Flexómetro largo 243



Rueda métrica 244



Tiralíneas 245



Escuadra 246



Calibre 247



Trazador 248



Marcador 248



**Llave Stillson reforzada**

ACERO FORJADO



Boca móvil y dentado postizo en Acero forjado

Mango en doble T en fundición de una sola pieza

Cabeza pulida

Dentado templado por inducción

**MODELO REFORZADO MAS LIGERO**

Code	L "	L mm	Ø max "	P.V.P. unid. €	
<b>111212</b>	12	300	1-1/4"	<b>15,89</b>	1
<b>111214</b>	14	350	1-1/2"	<b>19,18</b>	1
<b>111218</b>	18	450	2"	<b>26,05</b>	1
<b>111224</b>	24	600	2-1/2"	<b>44,73</b>	1
<b>111236</b>	36	900	3-1/2"	<b>86,58</b>	1

**Llave Stillson forjada**

ACERO FORJADO



- Cabeza templada a 45 HRC, pulida
- Dentado templado por inducción a 60 HRC
- Presentación del cuerpo y mango pintado

Code	L "	L mm	Ø max "	P.V.P. unid. €	
<b>111308</b>	8	200	3/4"	<b>10,82</b>	1
<b>111310</b>	10	250	1"	<b>13,28</b>	1
<b>111312</b>	12	300	1-1/4"	<b>15,42</b>	1
<b>111314</b>	14	350	1-1/2"	<b>18,62</b>	1
<b>111318</b>	18	450	2"	<b>23,00</b>	1
<b>111324</b>	24	600	2-1/2"	<b>39,00</b>	1
<b>111336</b>	36	900	3-1/2"	<b>79,00</b>	1

**Llave Stillson de aluminio**

ALUMINIO



- Perfil especial del mango que le da resistencia y ligereza a la llave
- Cabeza templada a 45 HRC, pulida
- Dentado templado por inducción a 60 HRC
- Presentación del cuerpo y mango pintado

Code	L "	L mm	Ø max "	P.V.P. unid. €	
<b>111410</b>	10	250	1-1/2"	<b>15,38</b>	1
<b>111412</b>	12	300	1-3/4"	<b>20,28</b>	1
<b>111414</b>	14	350	2"	<b>24,83</b>	1
<b>111418</b>	18	450	2-1/2"	<b>33,85</b>	1
<b>111424</b>	24	600	3"	<b>57,99</b>	1
<b>111436</b>	36	900	4"	<b>112,21</b>	1

## Llave Stillson de aluminio de ajuste transversal



**Nuevo**

- Cabeza templada a 45 HRC, pulida
- Dentado templado por inducción a 60 HRC
- Presentación del cuerpo y mango pintado

Code	L "	L mm	Ø max "	P.V.P. unid. €	
<b>111415</b>	14	350	2	<b>32,00</b>	1
<b>111419</b>	18	450	2-1/2	<b>45,00</b>	1
<b>111425</b>	24	600	3	<b>74,00</b>	1

## Boca de recambio para llave Stillson



**Nuevo**

## Tuerca de recambio para llave Stillson



**Nuevo**

Code	L "	Para code	P.V.P. unid. €	
<b>199181</b>	8	111308	<b>5,04</b>	1
<b>199184</b>	10	111310	<b>6,20</b>	1
<b>199187</b>	12	111312	<b>9,20</b>	1
<b>199190</b>	14	111314	<b>11,80</b>	1
<b>199193</b>	18	111318	<b>16,10</b>	1
<b>199196</b>	24	111324	<b>24,60</b>	1
<b>199199</b>	36	111336	<b>53,00</b>	1

Code	L "	Para code	P.V.P. unid. €	
<b>199180</b>	8	111308	<b>1,50</b>	1
<b>199183</b>	10	111310	<b>1,80</b>	1
<b>199186</b>	12	111312	<b>2,50</b>	1
<b>199189</b>	14	111314	<b>3,30</b>	1
<b>199192</b>	18	111318	<b>4,40</b>	1
<b>199195</b>	24	111324	<b>6,80</b>	1
<b>199198</b>	36	111336	<b>14,50</b>	1

## Llave para tubo combinada

ACERO FORJADO



- Cabeza templada a 45 HRC
- Dentado templado por inducción a 60 HRC
- Presentación del mango y del cuerpo pintado

Code	L mm	Capac.máx. Ø mm / "	P.V.P. unid. €	
<b>111375</b>	320	25/1	<b>19,66</b>	1
<b>111380</b>	425	40/1-1/2	<b>26,78</b>	1
<b>111385</b>	550	50/2	<b>41,76</b>	1
<b>111390</b>	630	75/3	<b>63,01</b>	1

## Llave para tubo recta

ACERO FORJADO



- Cabeza templada a 45 HRC
- Dentado templado por inducción a 60 HRC
- Presentación del mango y del cuerpo pintado

Code	L mm	Capac.máx. Ø mm / "	P.V.P. unid. €	
<b>111355</b>	320	25/1	<b>18,42</b>	1
<b>111360</b>	425	40/1-1/2	<b>25,05</b>	1
<b>111365</b>	550	50/2	<b>39,05</b>	1
<b>111370</b>	630	75/3	<b>58,96</b>	1

**Llave de cadena forjada**

ACERO FORJADO



**CADENA**  
L: 50 cm



- Cabeza templada a 40 HRC
- Dentado templado por inducción 52 HRC
- Presentación del cuerpo de la llave pintado
- Anilla metálica de sujeción

Code	L "	L mm	Ø max. mm	P.V.P. unid. €	
<b>111340</b>	12	300	150	<b>27,00</b>	1
CADENA DE RECAMBIO					
<b>111341</b>	20	para code 111340		<b>11,39</b>	1

**Llave de cadena forjada especial**

ACERO FORJADO



**CADENA**  
L: 62 cm



- Cabeza templada a 40 HRC
- Dentado templado por inducción 52 HRC
- Presentación del cuerpo de la llave pintado
- Anilla metálica de sujeción

Code	L "	L mm	Ø max. mm	P.V.P. unid. €	
<b>111342</b>	18	450	188	<b>45,00</b>	1
CADENA DE RECAMBIO					
<b>111343</b>	25	para code 111342		<b>19,36</b>	1

**Llave de cadena forjada larga**

ACERO FORJADO



**CADENA**  
**111350**  
L: 73 cm  
**111352**  
L: 85 cm



- Cabeza templada a 40 HRC
- Dentado templado por inducción 52 HRC
- Presentación del cuerpo de la llave pintado
- Cadena fabricada en Acero templado
- Anilla metálica de sujeción

Code	L "	L mm	L cadena mm/"	Ø max. mm	P.V.P. unid. €	
<b>111350</b>	24	600	730/29	210	<b>75,97</b>	1
<b>111352</b>	36	900	850/34	250	<b>143,00</b>	1
CADENA DE RECAMBIO						
<b>111351</b>		Para code 111350			<b>22,40</b>	1
<b>111353</b>		Para code 111352			<b>28,50</b>	1

**Llave de cadena para trabajos pesados**

ACERO FORJADO



**CADENA**  
**111344**  
L: 67 cm  
**111346**  
L: 82 cm



**Empleo en oleoductos, gasoductos y perforaciones**

- Cabeza forjada
- Dentado templado por inducción
- Cabeza con mordaza reversible
- Cadena en Acero templado

Code	L "	L mm	L cadena mm/"	Ø max. mm	P.V.P. unid. €	
<b>111344</b>	36	900	675/27	200	<b>92,60</b>	1
<b>111346</b>	40	1000	825/33	240	<b>127,65</b>	1
CADENA DE RECAMBIO						
<b>111345</b>		Para code 111344			<b>37,04</b>	1
<b>111347</b>		Para code 111346			<b>50,67</b>	1

## Llave forjada con cinta de cuero

ACERO FORJADO



**CORREA**  
L: 53 cm

**Empleo en cambios de filtro de aceite**

**ESPECIAL AUTOMOCION**

Code	L "	L mm	Ø max "	P.V.P. unid. €	
<b>111330</b>	9	225	4	<b>14,26</b>	1

## Llave de aluminio con cinta de nylon

ALUMINIO



**CORREA**  
L: 104 cm

- Cuerpo fabricado en aluminio
- Correa de nylon desmontable

Code	L "	L mm	Ø max "	P.V.P. unid. €	
<b>111338</b>	12	300	8	<b>28,00</b>	1

### CINTA DE RECAMBIO

<b>111339</b>	Para code 111338			<b>12,04</b>	1
---------------	------------------	--	--	--------------	---

## Cortatubos PVC Ø 42 mm

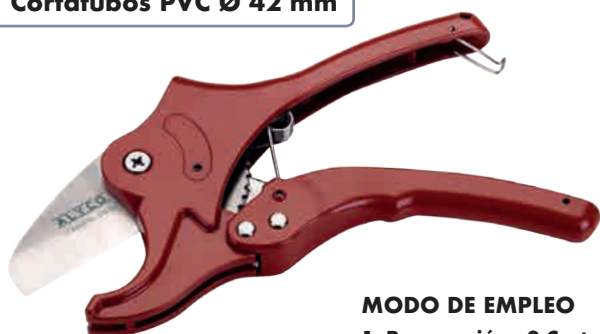

Con soporte de plástico para corte de superficies planas a 90° y 45°

### MODO DE EMPLEO

#### 1. Preparación 2. Corte 3. Avellanado

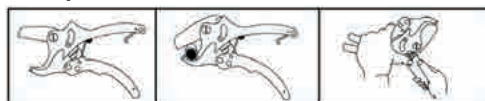

Retirar el seguro del mango y abrir los mangos

Colocar el tubo entre las cuchillas y apretar mangos repetidamente

Para avellanar la zona cortada, cerrar cortatubo y utilizar según la imagen.

### CAPACIDAD DE CORTE

Tipo de tubo	Ø interior mm	Ø exterior mm
PVC	<b>13-30</b>	<b>42</b>
Polietileno	<b>30</b>	<b>42</b>
Alambre	<b>14-26</b>	<b>42</b>

- Cuerpo de aluminio ligero
- Cuchilla de Acero inoxidable en V intercambiable
- Retorno rápido de la cuchilla
- Seguro de cierre
- Corte fácil debido al sistema de avance continuado sin retroceso de la cuchilla

Code	Ø mm	P.V.P. unid. €	
<b>108260</b>	42	<b>44,35</b>	1

Se suministra en blister

## Cortatubos PVC Ø 27 mm



- Mismas características que 108260
- No incluye soporte de plástico

### CAPACIDAD DE CORTE

Tipo de tubo	Ø interior mm	Ø exterior mm
PVC	<b>13-20</b>	<b>27</b>
Polietileno	<b>20</b>	<b>27</b>
Alambre	<b>14-20</b>	<b>27</b>

Code	Ø mm	P.V.P. unid. €	
<b>108250</b>	27	<b>27,00</b>	1

Se suministra en blister

## Cuchillas de recambio para cortatubos PVC

ACERO INOX



Cuchilla muy afilada. Utilizar guantes durante el cambio de cuchilla

Code	Para code	P.V.P. unid. €	
<b>108265</b>	108260	<b>10,51</b>	1
<b>108255</b>	108250	<b>6,39</b>	1

Se suministra en blister

**Cortatubos telescópico rápido**

**CAPACIDAD**  
Ø 6-70 mm

Cuatro rodillos (gran superficie de apoyo). Con alojamiento para tubos abocinados.

Incorpora avellanador con alojamiento en el cuerpo del cortatubo

Cuchilla de corte endurecida a 58÷62 HRC. Fácilmente sustituible

Avance de cuchilla por sistema telescópico

Palanca de soltado rápido

Mango ergonómico de gran grosor

Cuerpo de aluminio reforzado. Muy ligero.

Incorpora una cuchilla 111525 en el mango

**INCLUYE:**



Code	L mm	P.V.P. unid. €	
<b>111520</b>	220	<b>59,35</b>	1
CUCHILLAS DE REPUESTO			
<b>111525</b>	Cu-Bro-Al	<b>4,20</b>	10

Se suministra en blister

**Cortatubos telescópico**

**CAPACIDAD**  
Ø 3-45 mm

**INCLUYE:**



- Cuerpo de aluminio. Muy ligero
- Mango ergonómico
- 4 rodillos con alojamiento para tubos abocinados
- Incluye avellanador en el cuerpo del cortatubo
- Incluye cuchilla de recambio 111525 en el mango

Code	L mm	P.V.P. unid. €	
<b>111514</b>	170	<b>38,00</b>	1
CUCHILLAS DE REPUESTO			
<b>111525</b>	Cu-Bro-Al	<b>4,20</b>	10

Se suministra en blister

**Cortatubos telescópico**

**CAPACIDAD**  
Ø 3-35 mm

**INCLUYE:**



- Cuerpo de aluminio. Muy ligero
- Mango ergonómico
- 4 rodillos con alojamiento para tubos abocinados
- Incluye avellanador en el cuerpo del cortatubo
- Incluye cuchilla de recambio 111525 en el mango

Code	L mm	P.V.P. unid. €	
<b>111513</b>	140	<b>18,45</b>	1
CUCHILLAS DE REPUESTO			
<b>111525</b>	Cu-Bro-Al	<b>4,20</b>	10

Se suministra en blister

## Cortatubos forjado

**CAPACIDAD**  
Ø 12-50 mm



**Empleo en**  
tubos de acero

- Cuerpo reforzado de Acero fundido
- 2 rodillos pulidos
- Mango en T para facilitar el apriete y soltado

Code	L mm	P.V.P. unid. €	
<b>111522</b>	400	<b>78,49</b>	1

### CUCHILLAS DE REPUESTO

<b>111536</b>	Acero	<b>12,61</b>	1
---------------	-------	--------------	---

## Cortatubos forjado

**CAPACIDAD**  
Ø 32-100 mm



**Empleo en**  
tubos de acero

- Cuerpo reforzado de Acero fundido
- 2 rodillos pulidos
- Mango en T para facilitar el apriete y soltado

Code	L mm	P.V.P. unid. €	
<b>111524</b>	510	<b>135,00</b>	1

### CUCHILLAS DE REPUESTO

<b>111537</b>	Acero	<b>18,50</b>	1
---------------	-------	--------------	---



Incluye barra de 300 mm para grandes esfuerzos

## Cortatubos

**CAPACIDAD**  
Ø 3-30 mm



**INCLUYE:**



- Cuerpo de aluminio. Muy ligero
- Mango ergonómico
- 2 rodillos pulidos con alojamiento para tubos abocinados
- Incluye avellanador
- Incluye cuchilla de recambio en el mango

Code	L mm	P.V.P. unid. €	
<b>111510</b>	150	<b>13,25</b>	6

### CUCHILLAS DE REPUESTO

<b>111535</b>	Cu-Bro-Al	<b>2,83</b>	10
---------------	-----------	-------------	----

Se suministra en blister

## Cortatubos

**CAPACIDAD**  
Ø 15-45 mm



**INCLUYE:**



- Cuerpo de aluminio. Muy ligero
- Mango ergonómico
- 2 rodillos pulidos
- Incluye avellanador
- Incluye cuchilla de recambio en el mango

Code	L mm	P.V.P. unid. €	
<b>111511</b>	170	<b>20,00</b>	2

### CUCHILLAS DE REPUESTO

<b>111534</b>	Cu-Bro-Al	<b>4,00</b>	10
---------------	-----------	-------------	----

Se suministra en blister

## Mini cortatubos



**INCLUYE:**



- Cuerpo de aluminio
- 2 rodillos con alojamiento para tubos abocinados
- Incluye cuchilla 111535 para Cu-bronce-Al

Code	Ø mm	P.V.P. unid. €	
<b>111505</b>	3-16	<b>9,59</b>	1
<b>111506</b>	3-22	<b>9,94</b>	1
<b>111507</b>	3-28	<b>12,00</b>	1

### CUCHILLAS DE REPUESTO

<b>111535</b>	Cu-Bro-Al	<b>2,83</b>	10
---------------	-----------	-------------	----

Se suministra en blister

**Tornillo de banco para fontanero**

**FUNDICION NODULAR**

Medida 325x220x200 mm



- Cuerpo de hierro de fundición
- Dientes templados por inducción
- Mordaza superior móvil
- Con agujeros para fijación

Code	Ø "	Ø mm	P.V.P. unid. €	
<b>199335</b>	2	60	<b>56,89</b>	1

**Cortatubos automático**

**INSTRUCCIONES DE USO**

- Colocar el tubo en el interior del cortatubos. Se ajusta automáticamente
- Girar repetidas veces hasta que el tubo quede cortado
- Todas las medidas de cortatubo utilizan la misma cuchilla 111538



Code	Ø mm	Ø mm Tubo	P.V.P. unid. €	
<b>111501</b>	48	10	<b>17,72</b>	1
<b>111502</b>	52	12	<b>18,82</b>	1
<b>111503</b>	56	15	<b>20,18</b>	1
<b>111504</b>	68	22	<b>21,53</b>	1

**CUCHILLAS DE REPUESTO**

<b>111538</b>	Cu-Bro-Al	<b>3,87</b>	10
---------------	-----------	-------------	----

Se suministra en blister

**Rebarbador, cuerpo plástico**



**INCLUYE:**



- Con posibilidad de uso en dos sentidos
- Incluye cuchilla de recambio de Acero HSS

Code	L mm	P.V.P. unid. €	
<b>111545</b>	150	<b>11,91</b>	6

**Rebarbador, cuerpo metálico**



- Con posibilidad de uso en dos sentidos

Code	L mm	P.V.P. unid. €	
<b>111550</b>	150	<b>9,50</b>	6

**Cuchilla de recambio**



Code	Para code	P.V.P. unid. €	
<b>111551</b>	111545, 111550	<b>5,03</b>	6

**Avellanador para tubos**



Para avellanar el exterior del tubo



Para avellanar el interior del tubo

- 3 cuchillas fabricadas en Acero
- Cuerpo cilíndrico de plástico duro
- Para avellanar tubos tanto por la parte interior como la exterior, de 3 a 40 mm

Code	Medida Ø mm	P.V.P. unid. €	
<b>111540</b>	3-40	<b>11,00</b>	1

**Nivel tubular magnético de 3 fiolas**

**PRECISION:**  
**0,50 mm/m**  
**0,75 mm/m**

Forma ergonómica del cuerpo del nivel

Laterales con protección antichoque de goma

Imanes de 3 kg. de fuerza en la zona lateral y 5 kg. en la zona central. Imanes no visibles en el interior del nivel

Asas ergonómicas recubiertas de goma blanda

Superficies de apoyo en V para utilizar sobre tubos

Cuerpo de aluminio con ambas superficies de apoyo fresadas para una mayor precisión

196204 (solo un asa)

Code	L mm	A mm	B mm	P.V.P. unid. €	
<b>196204</b>	400	28	60	<b>26,50</b>	1
<b>196206</b>	600	28	60	<b>31,83</b>	1
<b>196208</b>	800	28	60	<b>37,18</b>	1
<b>196210</b>	1000	28	60	<b>47,70</b>	1
<b>196212</b>	1200	28	60	<b>53,76</b>	1

**Nivel trapezoidal de 3 fiolas**

**PRECISION:**  
**0,50 mm/m**

Agujero para colgar

Superficie de golpeo. Estructura reforzada que permite golpear sobre esta zona para la nivelación

Cuerpo de aluminio reforzado

Base con gran capacidad magnética

Medidas de 600 y 800 mm con tres fiolas (horizontal, vertical y 45°) y 400 mm con dos fiolas (horizontal y vertical)

Code	L mm	P.V.P. unid. €	
<b>196290</b>	400	<b>22,07</b>	1
<b>196292</b>	600	<b>29,33</b>	1
<b>196294</b>	800	<b>43,01</b>	1



**Nuevo**

**Nivel tubular**

**PRECISION:**



**0,50 mm/m**  
posición normal

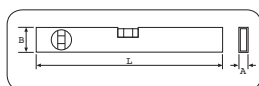

- Cuerpo de aluminio con ambas superficies de apoyo fresadas para una mayor precisión
- Superficie de trabajo mecanizada
- Laterales con protección antichoque de goma
- Tres fiolas: horizontal, vertical y 45°

Code	L mm	A mm	B mm	P.V.P. unid. €	
<b>196006</b>	400	27	52	<b>10,50</b>	6
<b>196008</b>	500	27	52	<b>12,10</b>	6
<b>196011</b>	600	27	52	<b>13,60</b>	6
<b>196016</b>	800	27	52	<b>16,90</b>	6
<b>196021</b>	1000	27	52	<b>19,80</b>	1
<b>196026</b>	1200	27	52	<b>24,40</b>	1

**Nivel tubular magnético**

**PRECISION:**



**0,50 mm/m**  
posición normal



2 imanes

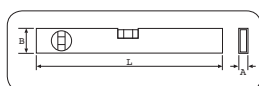

- Cuerpo de aluminio con ambas superficies de apoyo fresadas para una mayor precisión
- Superficie de trabajo mecanizada
- Laterales con protección antichoque de goma
- Tres fiolas: horizontal, vertical y 45°
- Con dos potentes imanes en la base para fijar el nivel sobre superficies metálicas

Code	L mm	A mm	B mm	P.V.P. unid. €	
<b>196181</b>	400	27	52	<b>14,60</b>	6
<b>196183</b>	500	27	52	<b>16,00</b>	6
<b>196185</b>	600	27	52	<b>17,20</b>	6
<b>196186</b>	800	27	52	<b>20,00</b>	6
<b>196187</b>	1000	27	52	<b>28,20</b>	6
<b>196188</b>	1200	27	52	<b>32,00</b>	6

**Nivel trapezoidal**

**PRECISION:**



**0,75 mm/m**  
posición normal

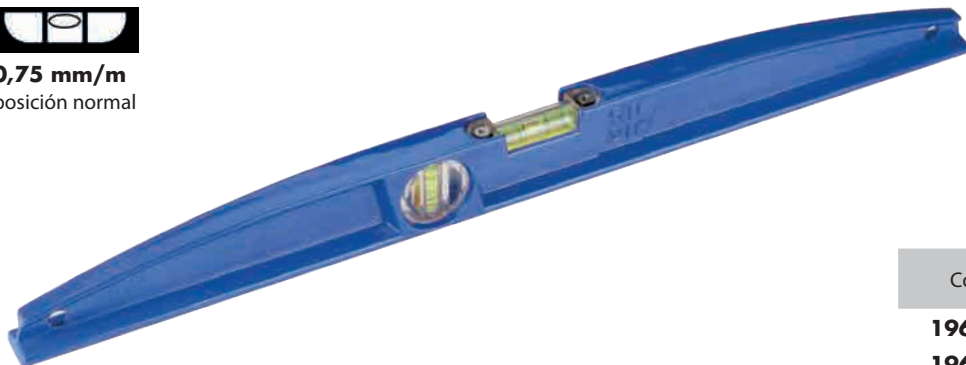

- Perfil en fundición inyectada de aluminio
- Superficie de trabajo mecanizada
- Una fiola vertical y otra horizontal

Code	L mm	P.V.P. unid. €	
<b>196280</b>	400	<b>10,21</b>	6
<b>196282</b>	600	<b>15,00</b>	6

## Nivel torpedo tubular magnético

PRECISION:



0,75 mm/m  
posición normal

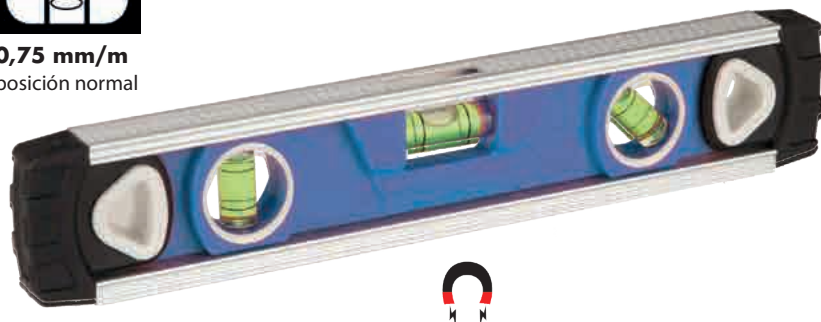

- Cuerpo de plástico con agujeros para colgar
- Base inferior magnética
- 3 fiolas a 90°, 180° y 45°

Code	L mm	P.V.P. unid. €	
<b>196252</b>	235	<b>5,50</b>	6

## Nivel torpedo tubular magnético

PRECISION:



0,50 mm/m  
posición normal

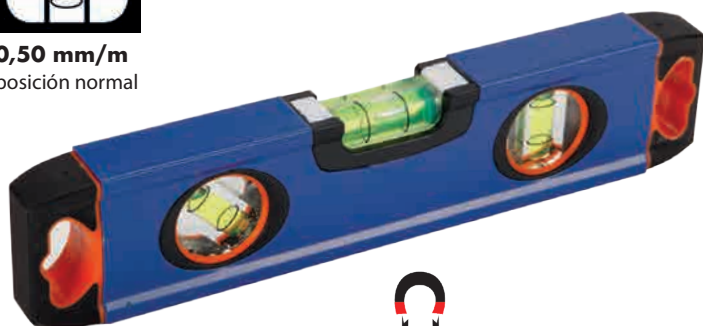

- Cuerpo de aluminio con protección antichoque
- Base magnética con imanes interiores
- 3 fiolas a 90°, 180° y 45°

Code	L mm	P.V.P. unid. €	
<b>196203</b>	250	<b>12,96</b>	6

## Nivel torpedo trapezoidal magnético

PRECISION:



0,50 mm/m  
posición normal

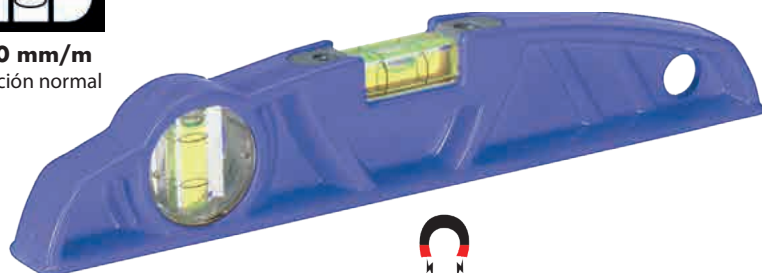

Base magnética

- Cuerpo de aluminio reforzado
- 2 fiolas a 90° y 180°

Code	L mm	P.V.P. unid. €	
<b>196288</b>	250	<b>17,00</b>	6

## Mini nivel de bolsillo con soporte

PRECISION:



1 mm/m  
posición normal



Medida: 70 x 20 x 41 mm

INCLUYE  
SOPORTE

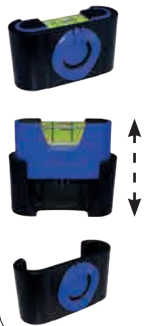

Con clip para colgar

- Cuerpo de plástico
- Base inferior magnética para nivelación horizontal
- 1 fiola de 180°

Code	P.V.P. unid. €	
<b>196255</b>	<b>5,50</b>	6

**Kit de Nivel Láser autonivelante**



**LASER CLASE 2**  
TIPO  $\lambda$  635 nm  
ALCANCE 15 m

**PRECISION:**



**0,50 mm/m**  
en la línea laser



**ATENCION LASER**



**USE GAFAS**

**APLICACIONES**



Haz vertical



Haz horizontal



Haz en cruz

**INCLUYE:**



**2 x AA**



**Instrucciones de uso**

**COMPOSICION**

- Nivel autoajustable (incluye dos pilas)
- Trípode aluminio regulable de 120 cm de altura
- Placa objetivo
- Gafas de seguridad
- Manual de instrucciones

Code	P.V.P. unid. €	
<b>196302</b>	<b>126,10</b>	<b>1</b>

**Nivel Laser**



**LASER CLASE 2**  
TIPO  $\lambda$  650 nm

**PRECISION:**



**0,50 mm/m**  
Fiola horizontal

**0,50 mm/m**  
Fiola vertical



**ATENCION LASER**



**USE GAFAS**

**INCLUYE:**



**2 x AAA**



**Instrucciones de uso**

**Nuevo**



**PRECISION DEL LASER**



**PUNTO LASER CRUZ LASER**

**MÁX 30 m**  
**+ 0,5mm/m**

**MÁX 10 m**  
**+ 1,0mm/m**

- Cuerpo de aluminio con protección
- 2 fiolas a 90° y 180°
- Base de trabajo con ranura en "V" para tubos

Code	L mm	P.V.P. unid. €	
<b>196303</b>	<b>400</b>	<b>64,50</b>	<b>1</b>

**Nivel angular digital**



**PRECISION:**



**0,50 mm/m**  
Fiola horizontal

**0,50 mm/m**  
Fiola vertical



**INCLUYE:**



**PPP3**



**Instrucciones de uso**

**Nuevo**

**PRECISION ANGULAR**



**RESOLUCION 0,1°**    **PRECISION + 0,5mm/m**

- Cuerpo de aluminio con protección
- 2 fiolas a 90° y 180°
- Guía angular con recorrido 0°-220°
- Lector digital con pantalla LCD con cálculo de diferencia de ángulos
- Cambio rápido de pila abriendo tapa de 2 tornillos

Code	L mm	P.V.P. unid. €	
<b>196304</b>	<b>380</b>	<b>64,00</b>	<b>1</b>

## Flexómetro magnético



CLASE II



Recubierta de nylon que evita el borrado



Pestaña magnética



Expositor 12 unidades (excepto 197324)

- Caja recubierta de goma antideslizante y antichoque
- Pestaña deslizable para mediciones exteriores o interiores
- Clip metálico en la parte posterior



### SISTEMA ANTIBLOQUEO:

- Extracción de la cinta de forma habitual.
- Movimiento de retroceso de la cinta solo cuando se mantiene pulsado el botón.

### MARCADO METRICA-PULGADAS



Code	m	mm	P.V.P. unid. €	
<b>197307</b>	3	16	<b>3,20</b>	12
<b>197317</b>	5	25	<b>5,50</b>	12

### MARCADO METRICA



Code	m	mm	P.V.P. unid. €	
<b>197305</b>	3	16	<b>3,00</b>	12
<b>197315</b>	5	25	<b>5,00</b>	12
<b>197324</b>	8	25	<b>7,50</b>	6

## Flexómetro



CLASE II



Expositor 12 unidades (en 197322 y 197320 no disponible)

- Cinta métrica en acero
- Caja recubierta de goma antideslizante antichoque
- Pestaña deslizable para mediciones exteriores-interiores
- Tres posiciones de frenado: bloqueo, semi-bloqueo, libre
- Clip metálico en la parte posterior

### MARCADO METRICA-PULGADAS



Code	m	mm	P.V.P. unid. €	
<b>197303</b>	3	16	<b>2,60</b>	12
<b>197312</b>	5	25	<b>4,20</b>	12

### MARCADO METRICA



Code	m	mm	P.V.P. unid. €	
<b>197300</b>	3	16	<b>2,00</b>	12
<b>197310</b>	5	25	<b>3,80</b>	12
<b>197320</b>	8	25	<b>5,00</b>	6
<b>197322</b>	10	25	<b>8,50</b>	6

**Flexómetro largo de cinta metálica**



CLASE II



Manilla para retroceso rápido



Sistema de sujeción de la anilla

- Cinta fabricada en Acero inoxidable
- Parte inicial de la cinta recubierta de plástico
- Caja bimaterial ergonómica

Code	m	mm	P.V.P. unid. €	
<b>197350</b>	20	13	<b>15,00</b>	1
<b>197360</b>	30	13	<b>21,00</b>	1

Se suministra en caja

**Flexómetro largo de cinta fibra de vidrio**



CLASE III



Anilla de plástico

Punto 0



- Cinta de fibra de vidrio recubierta de vinilo
- Cinta marcada por ambos lados
- Caja de flexómetro de plástico antichoque
- Manilla en la parte frontal para retroceso rápido
- Banda elástica para fácil manejo

Code	m	mm	P.V.P. unid. €	
<b>197325</b>	20	12,5	<b>11,50</b>	1
<b>197330</b>	30	12,5	<b>12,50</b>	1

Se suministra en caja

**Flexómetro largo cinta fibra de vidrio**



CLASE III



LONGITUD 50 M.

Cinta marcada por ambos lados

Anillo de plástico

Punto 0



- Mango bimaterial de gran tamaño
- Manilla para retroceso rápido de la cinta
- Punta para la fijación del flexómetro al suelo

Code	m	mm	P.V.P. unid. €	
<b>197340</b>	50	13	<b>23,00</b>	1

Rueda métrica



CAPACIDAD MEDICION  
MÁXIMA 10.000 M.

Ø DE LA RUEDA  
300 mm



PLEGABLE

- Rueda fabricada en poliuretano
- Barra de Aluminio con mango de goma ergonómico
- Botón de reset reforzado
- Pie metálico para dejar apoyada la rueda

Code	Ø rueda mm	P.V.P. unid. €	
197355	300	77,75	1

Se suministra en caja

Rueda métrica plegable



Freno y controlador  
del marcador



CAPACIDAD MEDICION  
MÁXIMA 10.000 M.

Ø DE LA RUEDA  
160 mm



TRIPLE PLEGADO  
ABIERTO: 1040 mm  
CERRADO: 430 mm

- Nuevo diseño del sistema de transmisión
- Freno y controlador del marcador desde el mango
- Botón de reset en el marcador
- Rueda de poliuretano
- Peso 1,1 kg
- Muy compacto para fácil uso y transporte

Code	P.V.P. unid. €	
197357	93,32	1

Se suministra en caja



Rueda centrada

**Tiralíneas en caja de plástico**

**Nuevo**

**RETROCESO  
RAPIDO  
6:1**



**LONGITUD DEL  
CORDÓN 30 M.**



- Cuerpo metálico con recubrimiento de goma exterior
- Ventana de llenado de polvo
- Cordón de poliéster que no deshilacha
- Gancho de Acero especial para fijar a diferentes superficies
- Posibilidad de bloqueo del cordón trazador (uso como plomada)

Code	P.V.P. unid. €	
<b>196190</b>	<b>8,00</b>	5

Se suministra en caja

**Nuevo**

**Juego de tiralíneas y polvo trazador**



**LONGITUD DEL  
CORDÓN 30 M.**

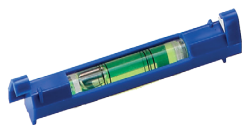

- COMPOSICION**
- Tiralíneas 196190
  - Bidón de polvo trazador de 113 gr.
  - Nivel de 75 mm.

Code	P.V.P. unid. €	
<b>196195</b>	<b>10,00</b>	4

Se suministra en blister

**Polvo trazador, Azulete**

**POLVO  
TRAZADOR  
AZUL**



196197



196199



196200



Contiene dióxido de silicio (SiO<sub>2</sub>) que puede ser dañino para la salud al ser inhalado.

- Bidón de plástico con boca especial para recarga
- Polvo extrafino azul

Code	Peso gr	P.V.P. unid. €	
<b>196197</b>	250	<b>2,60</b>	10
<b>196199</b>	500	<b>4,36</b>	6
<b>196200</b>	1000	<b>6,48</b>	4

## Escuadra

ACERO INOX

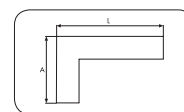

Graduación

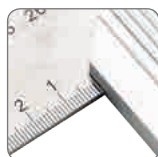

Unión reforzada

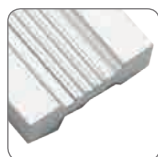

Perfil reforzado

- Hoja fabricada en Acero inoxidable
- Graduación de la hoja por ambos lados
- Mango de perfil de aluminio reforzado
- Unión remachada entre el mango y la regla

Code	L x A mm	P.V.P. unid. €	
<b>197375</b>	250x130	<b>8,06</b>	6
<b>197380</b>	300x150	<b>9,50</b>	6
<b>197385</b>	400x180	<b>11,76</b>	6
<b>197386</b>	600x200	<b>15,89</b>	6

## Regla

ACERO INOX

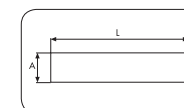

- Regla milimetrada por ambos lados

Code	L x A mm	P.V.P. unid. €	
<b>197280</b>	200x20	<b>1,07</b>	12
<b>197281</b>	300x25	<b>1,27</b>	12
<b>197282</b>	500x25	<b>2,81</b>	12

## Falsa escuadra

ACERO INOX



- Regla fabricada en Acero inoxidable
- Regla milimetrada por ambos lados
- Cuerpo reforzado de aluminio
- Graduación angular del mango para colocar la regla al ángulo deseado
- Tornillo de apriete-soltado de la regla.
- Posibilidad de regular el ángulo y la longitud

Code	L mm	P.V.P. unid. €	
<b>197398</b>	250	<b>10,50</b>	6
<b>197399</b>	300	<b>11,00</b>	6

## Escuadra con mango de Aluminio



- Hoja fabricada en Acero templado
- Regla milimetrada por ambos lados
- Mango de aluminio
- Unión remachada entre el mango y la regla

Code	L mm	P.V.P. unid. €	
<b>197390</b>	250	<b>3,50</b>	10
<b>197392</b>	300	<b>4,00</b>	10
<b>197394</b>	400	<b>4,70</b>	10
<b>197396</b>	600	<b>7,00</b>	10



**Escuadra multifunción 10 en 1**

**ACERO INOX**

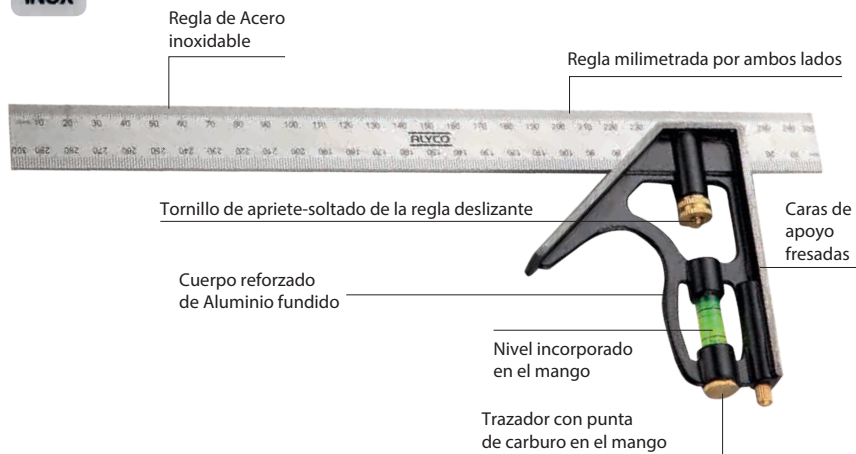

**FUNCIONES:**

- Regla milimetrada
- Escuadra interior 90°
- Escuadra exterior 90°
- Escuadra interior 135°
- Escuadra interior 45°
- Nivelación horizontal
- Nivelación vertical
- Escuadra en T con regla deslizante
- Medición de interiores

Code	L mm	P.V.P. unid. €	
<b>197415</b>	300	<b>13,00</b>	6
<b>197420</b>	400	<b>15,00</b>	6

**Calibre digital**

**ACERO INOX**



- Gran pantalla LCD con botones para ajustar y fijar las cotas a medir
- Lectura digital en mm y pulgadas + posición 0
- Bocas de 40 mm de profundidad
- Fijación de la lectura mediante tornillo

Code	L mm	Precisión mm	P.V.P. unid. €	
<b>197372</b>	150	0,01	<b>38,44</b>	1

**Calibre - Pie de Rey monobloc**

**ACERO INOX**

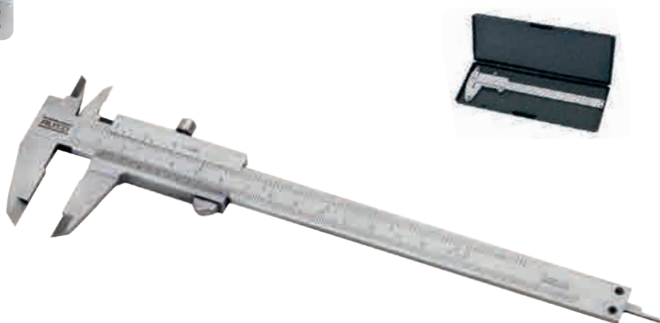

- Lectura en mm y pulgadas
- Bocas de 40 mm de profundidad
- Fijación de la lectura mediante tornillo

Code	L mm	Precisión mm	P.V.P. unid. €	
<b>197370</b>	150	0,05	<b>25,01</b>	1

**Micrómetro para exteriores**



- Cuerpo de acero fundido
- Bocas fabricadas en acero
- Casquillo y tambor cromados
- Freno para fijación de la lectura

Code	L mm	Precisión mm	P.V.P. unid. €	
<b>197374</b>	0-25	0,01	<b>20,00</b>	1

Se suministra en caja de plástico

## Galga de espesores



### COMPOSICION

0,05- 0,10- 0,15- 0,20- 0,25- 0,30- 0,35- 0,40- 0,45- 0,50- 0,55- 0,60- 0,65- 0,70- 0,75- 0,80- 0,85- 0,90- 0,95- 1mm

Code	Nº hojas	P.V.P. unid. €	
<b>197362</b>	20	<b>5,63</b>	6

## Galga para roscas métricas



### COMPOSICION



0,25- 0,30- 0,35- 0,40- 0,45- 0,50- 0,60- 0,70- 0,75- 0,80- 0,90- 1- 1,25- 1,50- 1,75- 2- 2,5- 3- 3,5- 4- 4,5- 5- 5,5- 6 mm

Code	Nº hojas	P.V.P. unid. €	
<b>197365</b>	24	<b>8,50</b>	6

## Punzón cilíndrico con mango

ACERO CR-V





Code	 mm	Ø mm	P.V.P. unid. €	
<b>119132</b>	125	6	<b>4,30</b>	12

## Punzón cuadrado con mango

ACERO CR-V



Code	 mm	□ mm	P.V.P. unid. €	
<b>119134</b>	125	6	<b>4,36</b>	12

## Portaminas trazador



• Punta del trazador fabricada en carburo de tungsteno

Code	L mm	P.V.P. unid. €	
<b>123000</b>	150	<b>8,00</b>	10
MINAS DE RECAMBIO			
<b>140030</b>	25	<b>4,00</b>	10

## Trazador



• Cuerpo en Acero al Cromo-Vanadio  
• Punta en carburo de tungsteno

Code	L mm	P.V.P. unid. €	
<b>123001</b>	150	<b>5,00</b>	10

## Trazador acodado

ANGULO 90°



• Cuerpo en Acero al Cromo-Vanadio  
• Punta de Acero templado 40-45 HRC

Code	L mm	Ø mm	P.V.P. unid. €	
<b>123005</b>	200	4	<b>4,26</b>	12

Se suministra en blister

## Compás de puntas



- Compás con muelle para trazado
- Puntas templadas
- Con tuerca para aproximaciones rápidas

Code	L mm	P.V.P. unid. €	
<b>149001</b>	100	<b>13,25</b>	6
<b>149002</b>	150	<b>14,46</b>	6
<b>149003</b>	200	<b>17,46</b>	6
<b>149004</b>	250	<b>18,63</b>	6

## Botador para ocultar cabezas de puntas



Code	Ø "	P.V.P. unid. €	
<b>140001</b>	1/32	<b>3,00</b>	12
<b>140002</b>	2/32	<b>3,00</b>	12
<b>140003</b>	3/32	<b>3,00</b>	12
<b>140004</b>	4/32	<b>3,00</b>	12

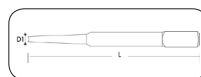

## Punzón centrador



Code	Ø "	P.V.P. unid. €	
<b>140006</b>	1/32	<b>3,50</b>	12
<b>140007</b>	2/32	<b>3,50</b>	12
<b>140008</b>	3/32	<b>3,50</b>	12
<b>140009</b>	4/32	<b>3,50</b>	12

## JUEGO DE BOTADORES

Code	Composición	P.V.P. unid. €
<b>140005</b>	140001/140002 140003/140004	<b>12,00</b>



## JUEGO DE PUNZONES

Code	Composición	P.V.P. unid. €
<b>140010</b>	140006/140007 140008/140009	<b>14,00</b>

## Punzón trazador para madera



Code	L mm	P.V.P. unid. €	
<b>140011</b>	100	<b>4,00</b>	12

## Rotulador punta fina



- Rotuladores de tinta permanente indeleble
- Punta de 9 mm

Code	L mm	Color	P.V.P. unid. €	
<b>149081</b>	120	<b>Rojo</b>	<b>1,11</b>	12
<b>149086</b>	120	<b>Negro</b>	<b>1,11</b>	12
<b>149087</b>	120	<b>Azul</b>	<b>1,11</b>	12

## Lápiz



- Lápiz con mina de grafito
- Cuerpo con forma ovalada
- Se suministra sin afilar

Code	L mm	P.V.P. unid. €	
<b>149050</b>	175	<b>0,38</b>	144

Venta sólo por embalaje completo

## Lápiz de 2 colores



**Azul** **Rojo**

Code	L mm	P.V.P. unid. €	
<b>149055</b>	175	<b>0,49</b>	144

Venta sólo por embalaje completo



## 13 Iluminación y electricidad



Linterna bifocal

251



Linterna automoción

253



Linterna frontal

256



Proyector

259



Proyector con trípode

260



Enrollacable

261



Base eléctrica

263



Cable de arranque

264

**Foco de batería recargable COB 20W**

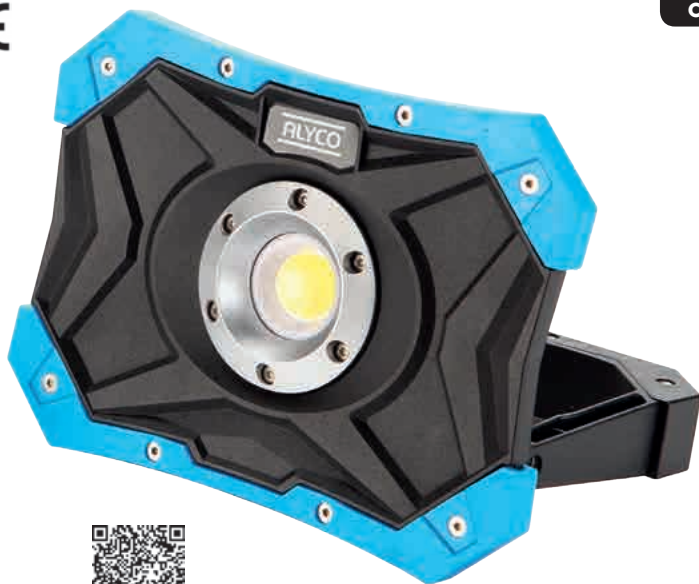

Instrucciones de uso



190x135x47 mm  
900 gr

<b>TIEMPO CARGA</b>	<b>DURACIÓN</b>
<b>4 Horas</b>	<b>3 Horas</b>

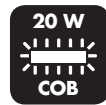

3,7 V.  
6600 mAh



**Nuevo**

**OPCIONES DE LUZ**



**ASA MAGNÉTICA**



**ACCESORIOS**



**COMPLEMENTOS**

- Indicador de carga de batería
- Salida USB 5V-1A para carga de dispositivos externos teléfonos móviles, tablets, GPS, drones...

Code	P.V.P. unid. €	
<b>199222</b>	<b>77,80</b>	<b>1</b>

**Foco de batería recargable COB 10W**

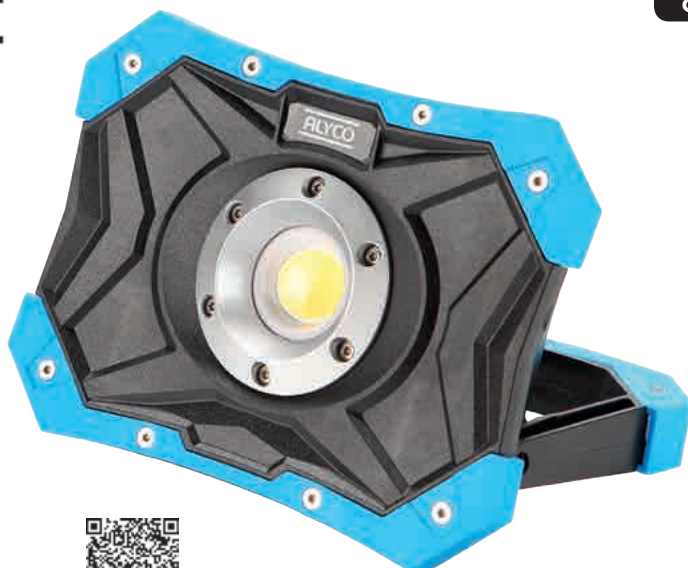

Instrucciones de uso



170x116x45 mm  
480 gr

<b>TIEMPO CARGA</b>	<b>DURACIÓN</b>
<b>4 Horas</b>	<b>3 Horas</b>

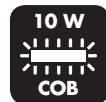

3,7 V.  
4400 mAh



**Nuevo**

**OPCIONES DE LUZ**



**ASA MAGNÉTICA**



**ACCESORIOS**



**COMPLEMENTOS**

- Indicador de carga de batería
- Salida USB 5V-1A para carga de dispositivos externos teléfonos móviles, tablets, GPS, drones...

Code	P.V.P. unid. €	
<b>199220</b>	<b>46,80</b>	<b>1</b>

Linterna bifocal recargable COB 10W



LINTERNA



3,7 V.  
4000 mAh



FOCO FRONTAL

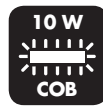

OPCIONES DE LUZ



Instrucciones de uso



240x45x45 mm  
400 gr

INCLUYE



Code	P.V.P. unid. €	
190573	62,20	1

Se suministra en blister

Linterna de batería recargable COB 3W

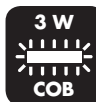

3,7 V.  
2200 mAh



Instrucciones de uso



160x40x35 mm  
140 gr

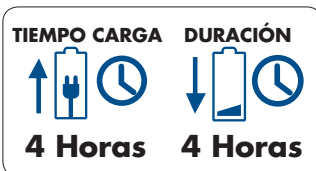

Batería con entrada USB para carga sin cables



Code	P.V.P. unid. €	
190571	22,05	1

**Linterna extrafina recargable 10W**



**Nuevo**

3,7 V.  
2600 mAh

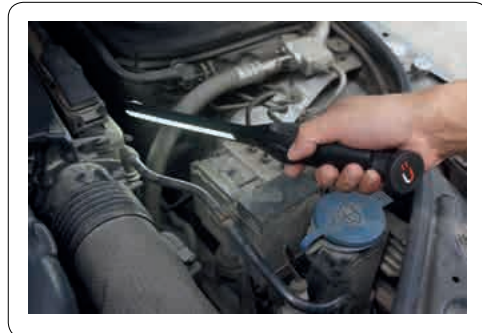

Linterna extrafina para acceder a espacios confinados



Instrucciones de uso



Base giratoria e imán para orientar la luz en cualquier ángulo



INCLUYE

<b>TIEMPO CARGA</b>	<b>DURACIÓN</b>
<b>5 Horas</b>	<b>3 Horas</b>

400x35x40 mm  
300 gr

Code	P.V.P. unid. €	
<b>190504</b>	<b>38,20</b>	1

Se suministra en blister

**Linterna recargable COB**



3,7 V.  
2200 mAh

380x68x68 mm  
450 gr

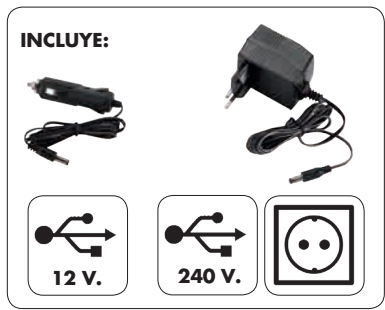

INCLUYE:

<b>TIEMPO CARGA</b>	<b>DURACIÓN</b>
<b>6 Horas</b>	<b>3 Horas</b>

Code	P.V.P. unid. €	
<b>190501</b>	<b>31,60</b>	1

Se suministra en blister

Incluye soporte magnético acoplable al cuerpo de la linterna

Linterna bifocal recargable COB 3W



LINTERNA



FOCO FRONTAL

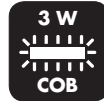

OPCIONES DE LUZ

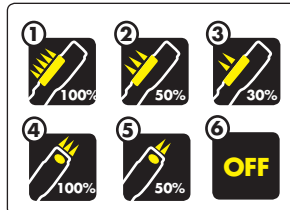

Mantener pulsado unos segundos el botón de encendido para cambiar la opción de luz



Instrucciones de uso

120x50x34 mm  
240 gr

TIEMPO CARGA	DURACIÓN
4 Horas	4 Horas

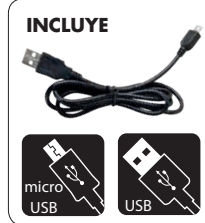

Code	P.V.P. unid. €	
190539	34,15	1

Se suministra en blister

Linterna de bolsillo COB 1W



OPCIONES DE LUZ



FOCO FRONTAL



Instrucciones de uso

173x33x20 mm  
40 gr

TIEMPO CARGA	DURACIÓN
4 Horas	2 Horas



Code	P.V.P. unid. €	
190543	18,90	1

Se suministra en blister





**Linterna bifocal abatible COB-LED 2W**



**INCLUYE**  
  
**3 x AA**

**Nuevo**

**FOCO FRONTAL**

**2 W**  
  
**200 Lumen**



218x51x31 mm  
230 gr



**LINTERNA**  
  
**1 LED** **30 Lumen**

**OPCIONES DE LUZ**

1 2 3

Code	P.V.P. unid. €	
<b>190512</b>	<b>9,30</b>	12

Se suministra en caja-expositor



**Linterna bifocal COB-LED 3W**



**INCLUYE**  
  
**3 x AAA**

**Nuevo**



95x64x34 mm  
90 gr



**LINTERNA**  
  
**1 LED** **45 Lumen**

**FOCO FRONTAL**  
**3 W**  
  
**200 Lumen**

**OPCIONES DE LUZ**

1 2 3

Code	P.V.P. unid. €	
<b>190538</b>	<b>4,80</b>	12

Se suministra en caja-expositor



**Linterna de bolsillo SMD 1W**



**INCLUYE**  
  
**3 x AAA**

**Nuevo**



173x31x27 mm  
34 gr

**LINTERNA**  
  
**1 LED** **15 Lumen**

**FOCO FRONTAL**  
**1 W**  
  
**35 Lumen**

**OPCIONES DE LUZ**

1 2 3

Code	P.V.P. unid. €	
<b>190546</b>	<b>4,20</b>	12

Se suministra en caja-expositor



Linterna frontal recargable CREE LED



3,7 V.  
5200 mAh



OPCIONES DE LUZ

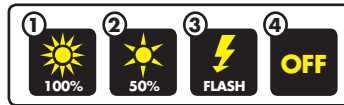

INCLUYE



Instrucciones de uso



TIEMPO CARGA	DURACIÓN
↑ 5 Horas	↓ 4 Horas

La linterna utiliza 2 baterías

- Estructura de aluminio y plástico ABS
- Inclinación ajustable 90°

Code	P.V.P. unid. €	
190561	36,00	1
BATERÍAS DE REPUESTO		
190558	8,00	1

Linterna frontal recargable CREE LED



3,7 V.  
4000 mAh



OPCIONES DE LUZ

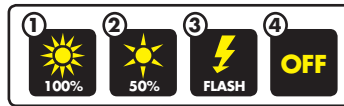

INCLUYE



Instrucciones de uso



TIEMPO CARGA	DURACIÓN
↑ 4 Horas	↓ 4 Horas

La linterna utiliza 2 baterías

- Estructura de aluminio y plástico ABS
- Inclinación ajustable 90°
- Indicador de carga de batería

Code	P.V.P. unid. €	
190562	28,50	1
BATERÍAS DE REPUESTO		
190558	8,00	1

Linterna frontal

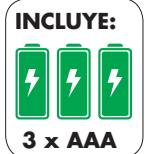

OPCIONES DE LUZ

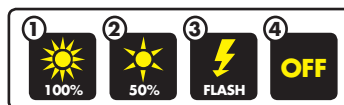

- Estructura de plástico ABS
- Inclinación ajustable

Code	P.V.P. unid. €	
190568	6,00	10

Se suministra en blister

**Luz telescópica flexible magnética 0,5 W**

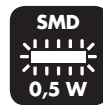

- Carcasa de aluminio de Ø 15 mm
- Foco de Ø 23 mm

Code	P.V.P. unid. €	
<b>190570</b>	<b>9,20</b>	12

Se suministra en blister

**Foco LED**

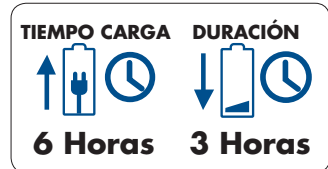

Code	P.V.P. unid. €	
<b>190552</b>	<b>32,50</b>	1

Se suministra en caja de cartón

**Lámpara portátil de obra**

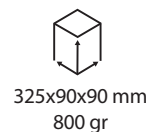
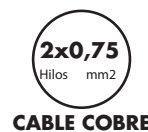

- No incluye bombilla
- Casquillo cerámico
- Reflector metálico

Code	P.V.P. unid. €	
<b>190535</b>	<b>16,63</b>	5

Se suministra en bolsa con colgador

**Cargador para cable USB**



- Entrada 100-240V AC / 50-60 Hz
- Salida 5V / 1000 mA



Code	P.V.P. unid. €	
<b>190559</b>	<b>4,50</b>	6

Linterna tubular 5W



Diámetro 54 mm

255x55x55 mm  
780 gr

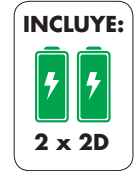
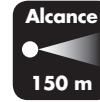

OPCIONES DE LUZ

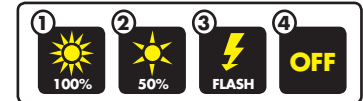

- Cuerpo fabricado en aluminio
- Lente resistente al rayado y al agua

Code	L mm	P.V.P. unid. €	
190577	250	35,70	1

Se suministra en blister

Linterna tubular 5W



Diámetro 34 mm

130x38x38 mm  
180 gr

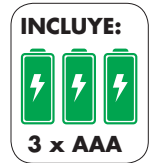

OPCIONES DE LUZ

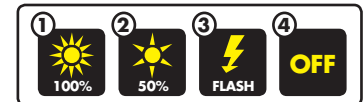

- Cuerpo fabricado en aluminio
- Lente resistente al rayado y al agua

Code	L mm	P.V.P. unid. €	
190575	130	19,40	1

Se suministra en blister

Lámpara de inspección de motor



ESPECIAL AUTOMOCION

1270x80x80 mm  
1800 gr

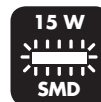

CUERPO EXTENSIBLE  
127 - 210 CM



Cable

- Ganchos recubiertos de goma para no dañar el capot

Code	P.V.P. unid. €	
190574	88,70	1

Se suministra en caja de cartón

**Nuevo**

**Proyector SMD 50W**

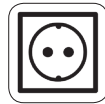
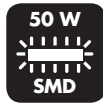

Extrafino

Inclinable



Instrucciones de uso



185x350x400 mm  
2,6 kg



Clase energética



Cable

- Carcasa de aluminio extrafina
- Marco de acero resistente
- Vidrio templado grueso
- Temperatura de trabajo: -20°/+50°

Code	P.V.P. unid. €	
199235	75,00	1

Se suministra en caja

**Proyector SMD 30W**

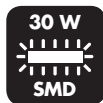

**Nuevo**



Extrafino

Inclinable



Instrucciones de uso



184x325x355 mm  
2,1 kg



Clase energética



Cable

- Carcasa de aluminio extrafina
- Marco de acero resistente
- Vidrio templado grueso
- Temperatura de trabajo: -20°/+50°

Code	P.V.P. unid. €	
199230	63,00	1

Se suministra en caja

**Proyector SMD 20W**

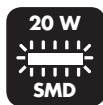

**Nuevo**



Extrafino

Inclinable



Instrucciones de uso



185x316x345 mm  
1,7 kg



Clase energética



Cable

- Carcasa de aluminio extrafina
- Marco de acero resistente
- Vidrio templado grueso
- Temperatura de trabajo: -20°/+50°

Code	P.V.P. unid. €	
199225	36,00	1

Se suministra en caja

2 proyectores LED con trípode

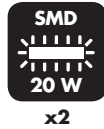

Triépode telescópico

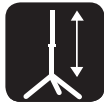

Máximo 158 cm  
Mínimo 67 cm



Instrucciones de uso



725x725x180 mm  
5 kg



Clase energética



Cable

- Carcasa de aluminio extrafina
- Triépode de acero resistente
- Vidrio templado grueso
- Temperatura de trabajo: -20°/+50°

Code	P.V.P. unid. €	
199228	98,00	1

Se suministra en caja de cartón

Foco SMD plegable 30 W

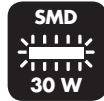

Instrucciones de uso



265x225x60 mm  
1,2 kg



Clase energética



Cable

- Carcasa de aluminio extrafina
- Marco de acero resistente
- Vidrio templado grueso
- Temperatura de trabajo: -20°/+50°

Code	P.V.P. unid. €	
199245	56,00	1

Se suministra en caja de cartón

Foco SMD plegable 20 W

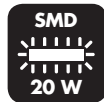

Instrucciones de uso



255x225x60 mm  
1,2 kg



Clase energética



Cable

- Carcasa de aluminio extrafina
- Marco de acero resistente
- Vidrio templado grueso
- Temperatura de trabajo: -20°/+50°

Code	P.V.P. unid. €	
199240	32,00	1

Se suministra en caja de cartón

**Nuevo**

**Enrollables de alta seguridad**



**Cu** **3x2,5** Hilos mm<sup>2</sup>

**CABLE COBRE**

**TIPO DE CABLE: H07RN-F 3G**

MAX. **1300W** - 230 V - **5,6 A**

MAX. **3600W** - 230 V - **15,6 A**

**IP44** **PROTECCION CONTRA LA INTEMPERIE**

- Protección 4 contra el polvo: objetos con diámetro mayor a 1 mm
- Protección 4 contra el agua: agua proyectada en todas las direcciones

**CABLE 2,5 mm<sup>2</sup>**

222x300x390mm  
199401 8 kg  
199426 13 kg

Code	L m	P.V.P. unid. €	
<b>199401</b>	25	<b>115,00</b>	1
<b>199426</b>	40	<b>150,00</b>	1

Se suministra en caja

**Enrollables con tapas de seguridad**



**Cu** **3x1,5** Hilos mm<sup>2</sup> **IP40**

**CABLE COBRE**



**TIPO DE CABLE: H05VV-F 3G**

MAX. **1000W** - 230 V - **4,3 A**

MAX. **3000W** - 230 V - **13 A**

**Enrollables**



**Cu** **3x1,5** Hilos mm<sup>2</sup> **IP20**

**CABLE COBRE**



**CON TAPAS**

200x260x340 mm  
199405 4 kg  
199430 7 kg

- Base y soporte de la empuñadura metálica
- Carrete fabricado en plástico de gran resistencia
- Bases para enchufe con dispositivo térmico de seguridad (botón rojo)
- Manivela para enrollar y desenrollar el cable
- Empuñadura con protector goma antideslizante

200x260x340 mm  
199400 4 kg  
199425 6 kg

Code	L m	P.V.P. unid. €	
<b>199405</b>	25	<b>51,13</b>	1
<b>199430</b>	50	<b>81,24</b>	1

Se suministra en caja

Code	L m	P.V.P. unid. €	
<b>199400</b>	25	<b>47,55</b>	1
<b>199425</b>	50	<b>78,08</b>	1

Se suministra en caja

Enrollables



CABLE COBRE

TIPO DE CABLE: H05VV-F



MAX. 1000W - 230 V - 4,3 A



MAX. 3000W - 230 V - 10 A

- Carrete fabricado en plástico de gran resistencia
- Bases para enchufe con dispositivo térmico de seguridad (botón rojo)

Code	L m	P.V.P. unid. €	
199409	5	12,68	5
199410	10	18,50	5
199415	15	25,56	5

Se suministra en caja

Prolongador de cable para exterior



SEGURIDAD CABLE COBRE

Nuevo

TIPO DE CABLE: H5VV-F



MAX. 3680W - 230 V - 16 A

- Prolongador con sistema de protección infantil
- Cable recubierto de PVC
- Cable bipolar + tierra

Code	L m	P.V.P. unid. €	
199416	15	20,50	1
199417	25	31,95	1

Prolongador de cable



SEGURIDAD CABLE COBRE

TIPO DE CABLE: H5VV-F



MAX. 3680W - 230 V - 16 A

- Prolongador con sistema de protección infantil
- Cable recubierto de PVC
- Cable bipolar + tierra

Code	L m	P.V.P. unid. €	
199472	2	6,08	1
199473	3	7,69	1
199474	4	9,36	1
199475	5	11,30	1



## Base múltiple de enchufes + USB



**2 TOMAS USB**  
2100 mA - 5V DC



SEGURIDAD CABLE COBRE



**Nuevo**

TIPO DE CABLE: H05VV-F  
MAX. 3680W - 230 V - 16 A



LONGITUD CABLE 1,40 M

- Base múltiple con sistema de protección infantil
- Base con interruptor manual con avisador óptico
- Cable bipolar + tierra 3G

Code	Nº enchufes	P.V.P. unid. €	
199433	3	14,40	1
199435	5	15,80	1
199436	6	16,60	1

## Base múltiple de enchufes con interruptor



LONGITUD CABLE 1,40 M Y 3 M



SEGURIDAD CABLE COBRE



TIPO DE CABLE: H05VV-F  
MAX. 3680W - 230 V - 16 A



- Base múltiple con sistema de protección infantil
- Base con interruptor manual con avisador óptico
- Cable bipolar + tierra 3G

Code	Nº enchufes	L cable m	P.V.P. unid. €	
199463	3	1,4	6,14	1
199464	4	1,4	6,56	1
199465	5	1,4	6,96	1
199466	6	1,4	7,49	1
<b>Nuevo</b> 199443	3	3	8,50	1
<b>Nuevo</b> 199444	4	3	8,80	1
<b>Nuevo</b> 199445	5	3	9,10	1
<b>Nuevo</b> 199446	6	3	9,50	1

## Base múltiple de enchufes



LONGITUD CABLE 1,40 M



SEGURIDAD CABLE COBRE



TIPO DE CABLE: H05VV-F  
MAX. 3680W - 230 V - 16 A



- Base múltiple con sistema de protección infantil
- Cable bipolar + tierra 3G

Code	Nº enchufes	P.V.P. unid. €	
199453	3	4,80	1
199454	4	5,00	1
199455	5	5,20	1
199456	6	5,80	1

Cable de arranque de Cobre



**PINZA**  
199370 **BRONCE**  
A  
160x100 mm

**CABLE** **Cu** 100%  
LONGITUD 3,5 M  
SECCION 35 mm<sup>2</sup>

Code	P.V.P. unid. €	
199375	120,00	1

Se suministra en bolsa

Cable de arranque de Cobre



**PINZA** **ACERO** **BRONCE**  
A  
185x120 mm

**CABLE** **Cu** 100%  
LONGITUD 3,5 M  
SECCION 25 mm<sup>2</sup>

Code	P.V.P. unid. €	
199377	55,00	1

Se suministra en bolsa

Cable de arranque de Cobre-Aluminio de 3 m



**PINZA** **ACERO** **ZINC**  
A  
190x130 mm

**CABLE** **Cu** **Al**  
LONGITUD 3 M  
SECCION 35 mm<sup>2</sup>

Code	P.V.P. unid. €	
199382	21,40	4

Se suministra en bolsa

Cable de arranque de Cobre-Aluminio de 2,5 m



**PINZA** **ACERO** **ZINC**  
A  
190x130 mm

**CABLE** **Cu** **Al**  
LONGITUD 2,5 M  
SECCION 25 mm<sup>2</sup>

Code	P.V.P. unid. €	
199380	16,30	5

Se suministra en bolsa

**Juego de 2 pinzas de batería de Bronce**

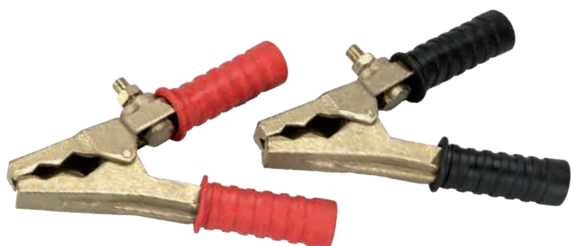

**PARA CABLE** 25-35 mm<sup>2</sup>  
Máx. Ø 11mm

- Cuerpo macizo de bronce
- Con tornillo para sujeción de cable
- Mangos ergonómicos y aislados en PVC
- Juego de 2 pinzas (1 roja + 1 negra)

Code	P.V.P. unid. €	
<b>199370</b>	<b>32,00</b>	1

Se suministra en bolsa con colgador

**Juego de 2 pinzas de batería de Bronce**

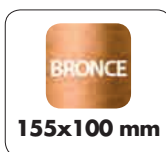
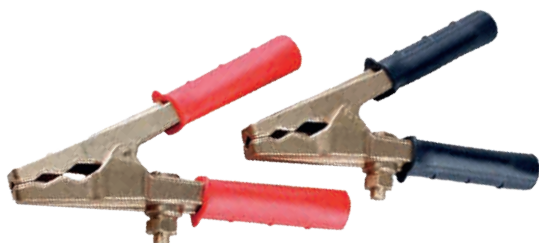

**PARA CABLE** 25-35 mm<sup>2</sup>  
Máx. Ø 11mm

- Cuerpo macizo de bronce
- Con tornillo para sujeción de cable
- Mangos ergonómicos y aislados en PVC
- Juego de 2 pinzas (1 roja + 1 negra)

Code	P.V.P. unid. €	
<b>199368</b>	<b>27,00</b>	1

Se suministra en bolsa con colgador

**Nuevo**

**Juego de 2 pinzas de batería de Acero**

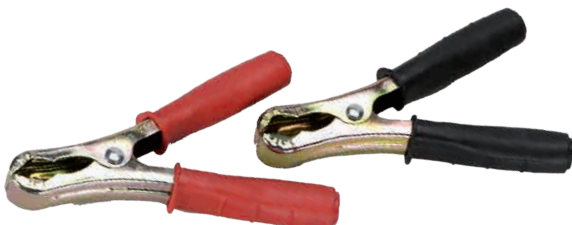

**PARA CABLE** 25-35 mm<sup>2</sup>  
Máx. Ø 11mm

- Cuerpo en Acero recubierto de Zinc
- Mangos ergonómicos y aislados en PVC
- Juego de 2 pinzas (1 roja + 1 negra)

Code	P.V.P. unid. €	
<b>199369</b>	<b>2,65</b>	12

Se suministra en bolsa con colgador

**Juego de 2 pinzas de batería de Acero**



**PARA CABLE** 25-35 mm<sup>2</sup>  
Máx. Ø 11mm

- Cuerpo en Acero recubierto de Zinc
- Mangos ergonómicos y aislados en PVC
- Juego de 2 pinzas (1 roja + 1 negra)

Code	P.V.P. unid. €	
<b>199367</b>	<b>1,95</b>	12

Se suministra en bolsa con colgador

**Juego de 2 pinzas de batería de Acero**



**PARA CABLE** 25-35 mm<sup>2</sup>  
Máx. Ø 11mm

- Cuerpo en Acero recubierto de Zinc
- Mangos ergonómicos y aislados en PVC
- Juego de 2 pinzas (1 roja + 1 negra)

Code	P.V.P. unid. €	
<b>199365</b>	<b>1,20</b>	12

Se suministra en bolsa con colgador



## 14 Herramienta varia



**Tornillo de banco** 267



**Ventosa** 269



**Masa magnética** 269



**Dedo magnético** 270



**Extractor** 272



**Alicate multifunción** 275



**Remachadora** 276



**Llave para filtros** 278



**Soldador eléctrico** 279



**Aplicador termosellante** 279



**Aplicador sellante** 280



**Aplicador para mortero** 280



**Aplicador poliuretano** 281



**Bomba de engrase** 282



**Bidón metálico** 283



**Aceitera** 283

**Tornillo de banco de guía redonda**

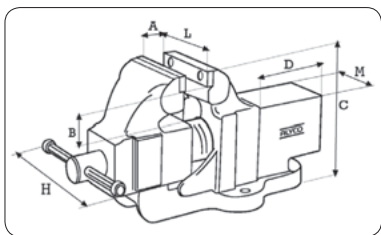

Dos puntos de engrase para un mantenimiento adecuado del mecanismo interior (2º punto en la parte posterior del husillo)

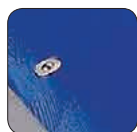

Topes laterales en la palanca de giro, para evitar su caída



- Bocas intercambiables
- Bocas templadas para una mayor duración
- Bocas moleteadas para mayor amarre
- Posibilidad de acoplar bocas de goma magnéticas

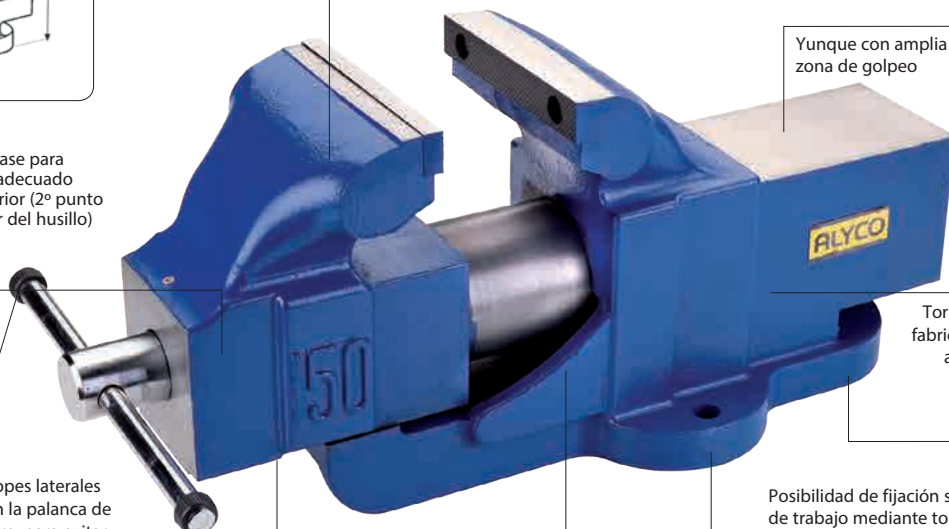

Yunque con amplia zona de golpeo

Tornillo de banco fabricado en Acero alta resistencia

2º punto de engrase

Posibilidad de fijación sobre mesa de trabajo mediante tornillo

Husillo interior recubierto en toda su longitud por guía cilíndrica

Ambas mordazas (fija y móvil) forjadas en una sola pieza

**CARACTERISTICAS DEL TORNILLO**

Code	A mm	B mm	C mm	DxM mm	H mm	Fuerza apriete kg
199350	110	61	197	109x100	13	5000
199355	135	63	225	144x125	14	6500
199360	165	72	247	152x150	15	7500

Code	L mm	Peso Kg	P.V.P. unid. €	
199350	100	15	257,45	1
199355	125	23	346,60	1
199360	150	32	483,82	1

Ver accesorios en página siguiente

**Tornillo de banco de guía cuadrada**



- Fabricado en Acero
- Mordaza fija y móvil forjadas en una sola pieza
- Bocas:
  - Intercambiables
  - Templadas para una mayor duración
  - Moleteadas para un mejor amarre
- Con base giratoria a 360°
- Zona de golpeo en el yunque
- Mordaza para tubos en la parte interior de las bocas

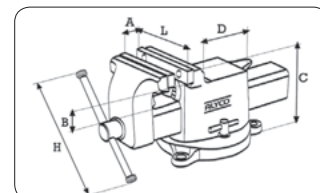

**CARACTERISTICAS DEL TORNILLO**

Code	A mm	B mm	C mm	D mm	H mm	Fuerza apriete kg
199300	75	33	137	39	11	2500
199305	100	43	145	49	11	3500
199310	125	44	145	49	12	4000
199315	150	56	181	74	13	5000

Code	L mm	Peso Kg	P.V.P. unid. €	
199300	75	6	100,16	1
199305	100	7,5	120,20	1
199310	125	11	143,54	1
199315	150	14,5	179,14	1

Ver accesorios en página siguiente

## Tornillo de sobremesa



**CAPACIDAD APRIETE**

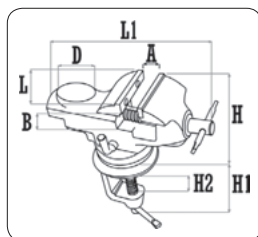

- Fabricado en fundición nodular
- Mordazas:
  - Intercambiables
  - Templadas para mayor duración
  - Moleteadas para mayor amarre
- Incluye base giratoria a 360°
- Zona de golpeo en el yunque
- Husillo para amarre sobre mesa de trabajo

### CARACTERÍSTICAS DEL TORNILLO

A máx. mm	B mm	H mm	H1 mm	D mm	L1 mm	H2 mm
90	38	100	126	55	200	62

Code	L mm	Peso Kg	P.V.P. unid. €	
<b>199325</b>	65	4	<b>65,00</b>	1

## Mordazas intercambiables metálicas



- Mordazas en Acero Cr-V. Templadas y moleteadas
- Se suministran con tornillos para su colocación

Code	L mm	mm	Para code	P.V.P. unid. €	
<b>199351</b>	100	70	199350	<b>21,61</b>	1 par
<b>199356</b>	125	87	199355	<b>32,62</b>	1 par
<b>199361</b>	150	108	199360	<b>38,07</b>	1 par
<b>199301</b>	75	58	199300	<b>18,03</b>	1 par
<b>199306</b>	100	70	199305	<b>22,66</b>	1 par
<b>199311</b>	125	87	199310	<b>25,96</b>	1 par
<b>199316</b>	150	108	199315	<b>27,13</b>	1 par

P.V.P. por pareja de mordazas

## Mordazas intercambiables de goma



- Banda magnética para acoplamiento en tornillo de banco
- Mordazas fabricadas en goma

Code	L mm	Para code	P.V.P. unid. €	
<b>199303</b>	75	199300	<b>24,93</b>	1 par
<b>199308</b>	100	199350/199305	<b>30,34</b>	1 par
<b>199313</b>	125	199355/199310	<b>35,64</b>	1 par
<b>199318</b>	150	199360/199315	<b>37,70</b>	1 par

P.V.P. por pareja de mordazas

## Base giratoria



- Se suministra con tornillos, pasadores y pletina para su colocación

Code	Para code	P.V.P. unid. €	
<b>199302</b>	199300	<b>17,81</b>	1
<b>199307</b>	199305	<b>21,72</b>	1
<b>199312</b>	199310	<b>26,34</b>	1
<b>199317</b>	199315	<b>31,42</b>	1

## Mordaza manual para taladro

**CAPACIDAD APRIETE**



- UTILIZACION:**
- Taladros de mesa
  - Mesas de trabajo

### CARACTERÍSTICAS

Apertura máx. mm	Anchura mm	Profundidad mm
100	100	36

- Ranuras laterales para fijarlos a mesas con guías
- Mordazas de Acero con ranura en V para sujeción de piezas cilíndricas

Code	P.V.P. unid. €	
<b>199330</b>	<b>26,35</b>	1

## Ventosa de un cuerpo

**CAPACIDAD SUCCION**

**45 kg.**



**UTILIZACION:**

- Cristal
- Plástico
- Metal
- Mármol
- Granito
- Superficies lisas

Code	Ø mm	P.V.P. unid. €	
<b>198005</b>	100	<b>17,00</b>	2

## Ventosa de doble cuerpo

**CAPACIDAD SUCCION**

**60 kg.**



**UTILIZACION:**

- Cristal
- Plástico
- Metal
- Mármol
- Granito
- Superficies lisas

Code	Ø mm	P.V.P. unid. €	
<b>198010</b>	2x100	<b>42,00</b>	1

**Nuevo**

## Masa magnética



- Imán de ferrita
- Mango giratorio 360° con muelle ajustable
- Incluye tuercas de acero, arandelas y tornillos

Code	Ø mm	Fuerza kg	Amp.	P.V.P. unid. €	
<b>198002</b>	50	7	200	<b>4,80</b>	10
<b>198004</b>	86	30	500	<b>11,00</b>	10

Se suministra en blister

## Angulo Magnético

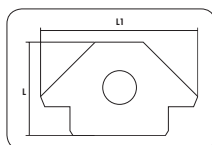
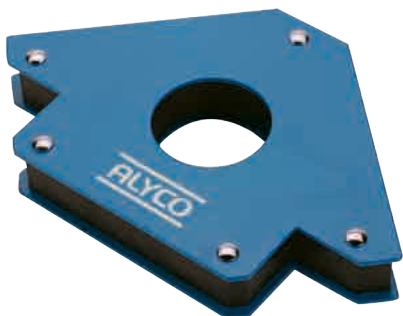

Soldadura 90°



Soldadura 45°

- Cuerpo fabricado en Acero
- Cuerpo unido por remaches
- Parte interior con potente imán
- Agujero para utilizar como elevador con grua

Code	L mm	L1 mm	P.V.P. unid. €	
<b>197990</b>	85	120	<b>4,50</b>	10
<b>197992</b>	100	155	<b>7,00</b>	10
<b>197995</b>	120	185	<b>10,90</b>	10
<b>197996</b>	150	200	<b>12,80</b>	10

**Nuevo**

Se suministra en blister

## Ángulo magnético para interiores

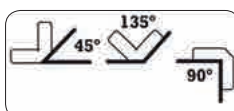

**Arrastre 13 Kg**  
**Elevación 9 Kg**

**Nuevo**

- Cuerpo fabricado en Acero
- Cuerpo unido por remaches
- Parte interior con potente imán
- Agujero para utilizar como elevador con grua

Code	P.V.P. unid. €	
<b>197998</b>	<b>5,80</b>	10

Se suministra en blister

## Pinza magnética flexible con luz

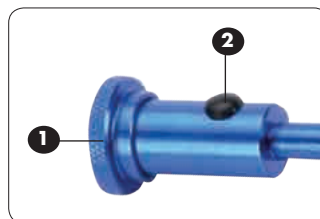
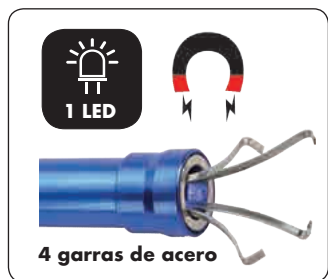
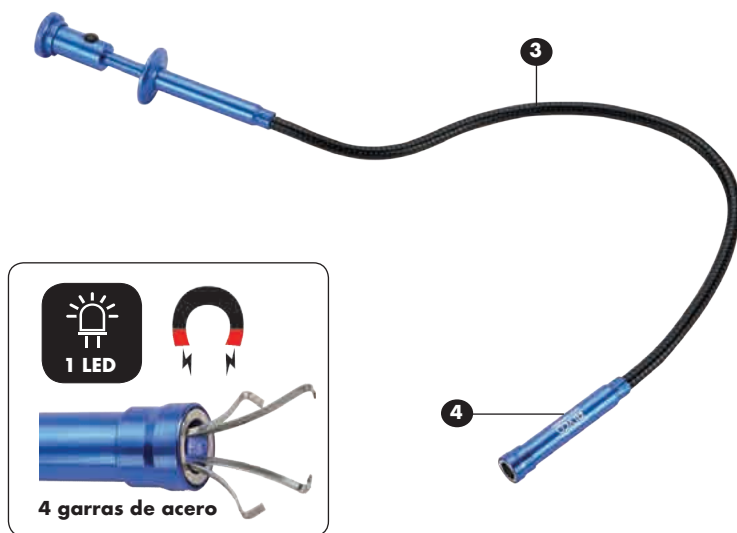

**INCLUYE:**

3 x LR44

- 1 Botón para apertura de las garras
- 2 Botón encendido/apagado luz LED
- 3 Parte central del cuerpo flexible
- 4 Cuerpo fabricado en Aluminio muy ligero

Code	L mm	P.V.P. unid. €	
<b>121550</b>	600	<b>11,00</b>	6

Se suministra en blister

## Espejo telescópico de inspección con luz

ACERO INOX



**INCLUYE:**

2 x CR2032

- 1 Espejo de 84x52 mm
- 2 Junta universal para giro, inclinación y fijación
- 3 Mango ergonómico antideslizante

Code	L mm	P.V.P. unid. €	
<b>121555</b>	290 / 876	<b>6,60</b>	6

Se suministra en blister

## Dedo magnético con mango



Code	L mm	Ø Imán	Cap Kg	P.V.P. unid. €	
<b>119135</b>	510	10	1	<b>18,94</b>	1
<b>119140</b>	510	20	3	<b>22,50</b>	1

## Pasahilos extraíble de nylon

Ø 4 MM NYLON

NO CONDUCTOR



**Para pasar todo tipo de cables**

Code	L m	P.V.P. unid. €	
<b>198915</b>	15	<b>18,50</b>	1
<b>198925</b>	25	<b>24,30</b>	1



**Sacagrapas**

ACERO  
CR-V



**Empleo en automoción  
para la extracción de grapas**

- Terminación pulido cromado
- Mango bicomponente ergonómico

Code	Ø mm	L mm	P.V.P. unid. €	
<b>118015</b>	8	190	<b>4,80</b>	6
<b>118020</b>	10	235	<b>6,26</b>	6

Se suministra en blister

**Juego de sacagrapas**



Code	Nº piezas	P.V.P. unid. €	
<b>118030</b>	5	<b>28,61</b>	1

Se suministra en caja de cartón

**Juego de palancas de nylon**

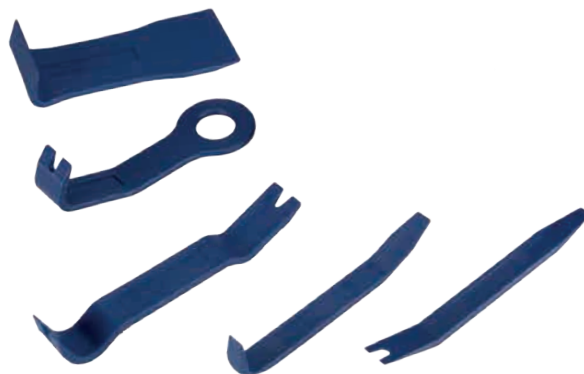

**Empleo en extracción e instalación  
de molduras, salpicaderos y  
tapicerías de vehículos**

Code	Nº piezas	P.V.P. unid. €	
<b>118035</b>	5	<b>25,00</b>	1

Se suministra en blister

**Juego de extractores para tornillos rotos**

ACERO  
CR-V



- Extractor de espárragos para tuercas, tornillos y pernos rotos

COMPOSICION			
Nº	Ø mm	Ø "	para métrica
1	1,4/3,6	1/8-1/4	M3 - M6
2	2,1/4,9	1/4-5/16	M6 - M8
3	3,1/6,5	5/16-7/16	M8 - M11
4	4,8/8,8	7/16-9/16	M11 - M14
5	6,2/11	9/16-3/4	M14 - M18

Code	Nº piezas	P.V.P. unid. €	
<b>122330</b>	5	<b>11,50</b>	1

Se suministra en blister

## Extractor regulable de 2 patas

ACERO  
CR-V

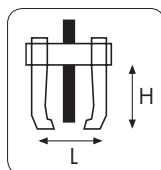

**Para cambiar y extraer ruedas, engranajes, rodamientos a bolas, poleas, etc.**

• Patas forjadas en una pieza para su utilización en trabajos de gran exigencia

Code	H mm	L máx. mm	L mín mm	P.V.P. unid. €	
<b>122300</b>	100	85	15	<b>59,34</b>	1
<b>122305</b>	100	125	15	<b>65,04</b>	1
<b>122310</b>	150	160	20	<b>108,88</b>	1
<b>122315</b>	150	200	20	<b>175,00</b>	1

## Extractor reversible de 2 patas

ACERO  
CR-V



• Extractor autocentrante  
• Terminación satinado mate, husillo pavonado

Code	Ø mm	P.V.P. unid. €	
<b>122350</b>	75	<b>21,00</b>	1
<b>122355</b>	150	<b>36,50</b>	1
<b>122360</b>	200	<b>59,90</b>	1

## Extractor múltiple de 2 patas

ACERO  
CR-V



**3 LONGITUDES DE PATA:  
100 / 200 / 250 mm**



**Para utilizar como extractor interno y externo**

### CAPACIDAD Ø MM

Utilización	mín	máx
Interna	80	180
Externa	25	130

### COMPOSICION

- Soporte forjado para patas de 175 mm  
- Husillo central M12 x 150 mm  
- 2 patas forjadas de 100 mm  
- 2 patas forjadas de 200 mm  
- 2 patas forjadas de 250 mm

Code	P.V.P. unid. €	
<b>122365</b>	<b>120,00</b>	1

## Patas de recambio

ACERO  
CR-V



Válido para 122365/ 122390/ 122395

**Nuevo**

• Extremo de las patas en Acero Cr-V

Code	L mm	P.V.P. unid. €	
<b>122210</b>	100	<b>12,00</b>	1
<b>122212</b>	150	<b>16,00</b>	1
<b>122214</b>	200	<b>20,00</b>	1

**Extractor reversible de 3 patas**

ACERO  
CR-V



- Extractor autocentrante
- Terminación satinado mate, husillo pavonado

Code	Ø mm	P.V.P. unid. €	
<b>122375</b>	75	<b>28,38</b>	1
<b>122380</b>	150	<b>50,80</b>	1
<b>122385</b>	200	<b>89,00</b>	1

**Extractor múltiple de 3 patas**

ACERO  
CR-V



**3 LONGITUDES DE PATA:  
100 / 200 / 250 mm**



**CAPACIDAD Ø MM**

Utilización	min	máx
Interna	80	180
Externa	25	130

**COMPOSICION**

- Soporte forjado para patas de 175 mm
- Husillo central M12 x 150 mm
- 3 patas forjadas de 100 mm
- 3 patas forjadas de 200 mm
- 3 patas forjadas de 250 mm

**Para utilizar como extractor interno y externo**

- Extremo de las patas en Acero Cr-V
- Patas de recambio disponibles

Code	P.V.P. unid. €	
<b>122390</b>	<b>154,22</b>	1

**Juego de extractor de 2 y 3 patas**

**3 LONGITUDES DE PATA:  
100 / 200 / 250 mm**

**6 EXTRACTORES EN 1**



**COMPOSICION**

- Soporte forjado para extractor 2 patas
- Soporte forjado para extractor 3 patas
- Husillo central M12 x 150 mm
- 3 patas forjadas de 100 mm
- 3 patas forjadas de 200 mm
- 3 patas forjadas de 250 mm

- Extremo de las patas en Acero Cr-V
- Patas de recambio disponibles

Code	P.V.P. unid. €	
<b>122395</b>	<b>187,83</b>	1

Mismas características que 122365 y 122390

## Juego de separadores de guillotina

ACERO  
CR-V



Para la extracción de  
rodamientos, cajas de cambio,  
poleas y volantes

### COMPOSICION

1 Guillotina de 30 x 50 mm  
1 Guillotina de 50 x 75 mm

• Separadores en Acero Cr-V

Code	P.V.P. unid. €	
<b>122200</b>	<b>94,25</b>	1

## Separador de guillotina

ACERO  
CR-V



Code	Ø mín mm	Ø máx mm	P.V.P. unid. €	
<b>122204</b>	75	105	<b>38,86</b>	1
<b>122206</b>	100	150	<b>99,00</b>	1

## Extractor universal de rótulas

ACERO  
CR-V



Code	A mín / máx	B mín / máx	P.V.P. unid. €	
<b>122220</b>	12 / 50	18 / 22	<b>12,75</b>	1

## Extractor de rótulas

ACERO  
CR-V



Code	A mín / máx	B mm	P.V.P. unid. €	
<b>122225</b>	12 / 50	20	<b>22,10</b>	1

## Extractor de rótulas

ACERO  
CR-V



Code	A mín / máx	B mm	P.V.P. unid. €	
<b>122230</b>	60 / 80	20	<b>28,73</b>	1

**Alicate multifunción en bolsa de nylon**

**ACERO INOX**

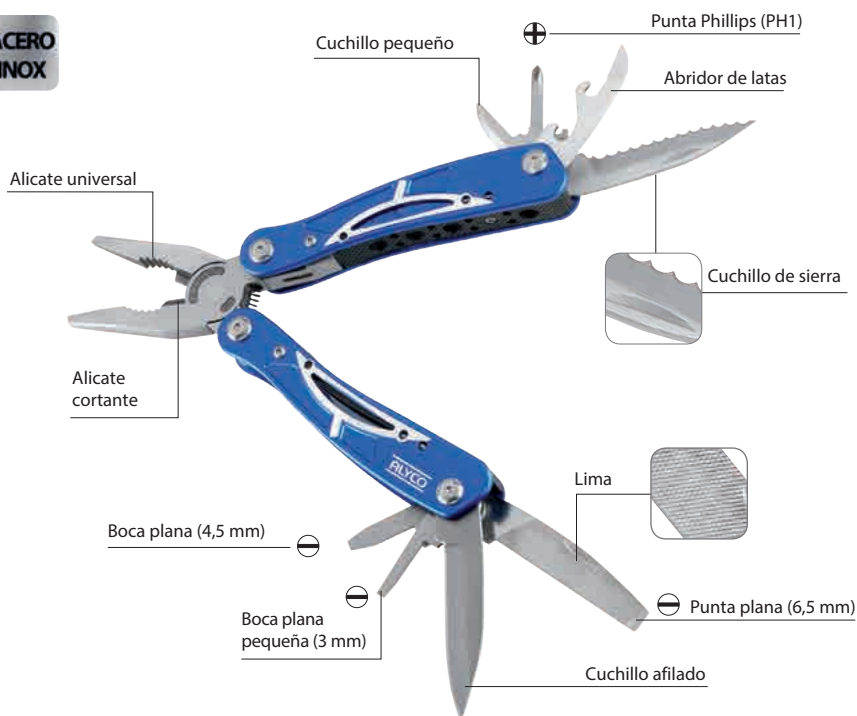

Alicate cerrado



Alicate abierto

- Mangos fabricados en Aluminio anodizado
- Se suministra con bolsa de nylon individual

Code	L abierto mm	P.V.P. unid. €	
<b>101260</b>	160	<b>17,00</b>	6

**Se suministra en blister y expositor**

**Kit de alicate multifunción y navaja en bolsa de nylon**

**ACERO INOX**



**CARACTERISTICAS NAVAJA:**

- Hoja fabricada en Acero inoxidable
- Hoja abatible sobre el mango
- Mango de Aluminio anodizado
- Con clip metálico en parte posterior
- Con filo de corte liso



**COMPOSICION**

- 101260 - Alicata multifunción
- Navaja con mango de Aluminio
- Bolsa de Nylon

Code	Nº Piezas	P.V.P. unid. €	
<b>101265</b>	3	<b>21,00</b>	6

**Se suministra en blister y expositor**

**Mini-alicate multifunción**

**ACERO INOX**



**FUNCIONES**

- Alicata universal
- Alicata bocas planas
- Boca plana 4 mm
- Lima
- Alicata cortacables
- Cuchillo de sierra
- Punta Phillips (PH1)
- Cuchillo pequeño
- Abridor de latas con boca plana (3 mm)

Code	L mm abierto	L mm cerrado	P.V.P. unid. €	
<b>101267</b>	110	72	<b>10,79</b>	6

**Se suministra en blister y expositor**

## Remachadora alta potencia de 2 manos

30% MENOS ESFUERZO



INCLUYE 4 BOCAS

## Juego de remachadora

INCLUYE 4 BOCAS, REMACHES Y ARANDELAS



Medida de caja: 325x155x55 mm

## Remachadora de 2 manos

INCLUYE 4 BOCAS  
3,2-4,0-4,8-6,4 MM



## Accesorios de remachadora de 2 manos



183113



183112

### COMPOSICION BOCAS

#### 183105 PARA REMACHES

- Ø 2'4 mm - 3/32"
- Ø 3'2 mm - 1/8"
- Ø 4'0 mm - 5/32"
- Ø 4'8 mm - 3/16"



#### 183115 PARA REMACHES

- Ø 3'2 mm - 1/8"
- Ø 4'0 mm - 5/32"
- Ø 4'8 mm - 3/16"
- Ø 6'4 mm - 1/4"



- Cuerpo fabricado en Aluminio
- Mangos ergonómicos bimateriales
- Incluye llave para cambiar las bocas
- Incluye 4 bocas de diferentes tamaños
- Con botella de plástico recogedora de remaches

### Utilizable con remaches inoxidables

Code	L mm	P.V.P. unid. €	
<b>183105</b>	300	<b>35,77</b>	1
<b>183115</b>	325	<b>49,40</b>	1

### COMPOSICION

- 1 remachadora con cuatro bocas: 2,4 - 3,2 - 4,0 - 4,8 mm
- 80 remaches:
  - 20 de 2,4 mm
  - 20 de 3,2 mm
  - 20 de 4,0 mm
  - 20 de 4,8 mm
- 20 arandelas:
  - 5 de 2,4 mm
  - 5 de 3,2 mm
  - 5 de 4,0 mm
  - 5 de 4,8 mm

- Cuerpo fabricado en aluminio
- Palanca móvil forjada
- Mango ergonómico
- Cierre de seguridad
- Bocas fabricadas en Acero

### Utilizable con remaches inoxidables

Code	L mm	P.V.P. unid. €	
<b>183100</b>	250	<b>31,89</b>	1

### Se suministra en caja de plástico

- Cuerpo fabricado en aluminio
- Mangos tubulares fabricados en Acero
- Mangos ergonómicos fabricados en goma blanda
- Bocas fabricadas en Acero
- Cierre de seguridad
- Incluye llave para cambio de bocas
- Bote de plástico para los remaches utilizados

### Utilizable con remaches inoxidables

Code	L mm	P.V.P. unid. €	
<b>183110</b>	450	<b>60,23</b>	1

Code		P.V.P. unid. €	
<b>183113</b>	<b>BOTE DE REMACHES</b>	<b>4,00</b>	1
<b>183112</b>	<b>JUEGO DE BOCAS</b>	<b>8,00</b>	1

**Remachadora extensible**

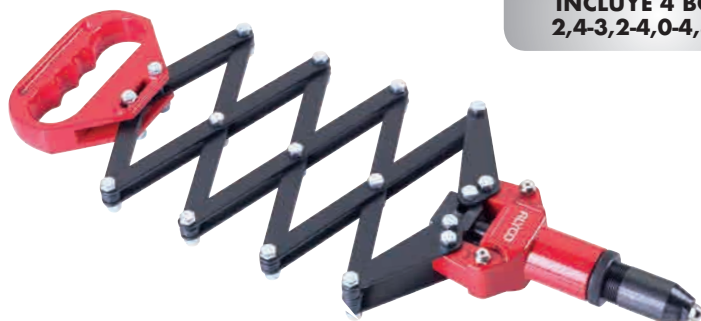

**INCLUYE 4 BOCAS**  
2,4-3,2-4,0-4,8 MM

- Cuerpo fabricado en aluminio
- Corredera con 4 remaches en Acero
- Mango ergonómico de Aluminio
- Bocas fabricadas en Acero

**Utilizable con remaches inoxidables**

Code	L mm mín. máx.	P.V.P. unid. €	
<b>183130</b>	320 850	<b>74,55</b>	1

**COMPOSICION**

1 remachadora para tuercas  
4 bocas para tuercas M3, M4, M5, M6  
40 tuercas: 10 - M3 / 10 - M4 / 10 - M5 / 10-M6

- Cuerpo fabricado en aluminio
- Mangos ergonómicos recubiertos de PVC
- Cierre de seguridad

**Utilizable con remaches inoxidables**

Code	L mm	P.V.P. unid. €	
<b>183125</b>	250	<b>48,88</b>	1

**Juego de remachadora para tuercas**



Medida caja: 325 x 155 x 55 mm

**Remachadora para tuercas de 2 manos**



**INCLUYE 4 BOCAS PARA**  
**TUERCAS M5, M6, M8, M10**

- Cuerpo fabricado en aluminio
- Mangos tubulares fabricados en Acero
- Empuñaduras ergonómicas en goma blanda

**Utilizable con remaches inoxidables**

Code	L mm	P.V.P. unid. €	
<b>183120</b>	450	<b>80,58</b>	1

**Boca de recambio**

**PARA 183125**



Code	Ø M	L mm	P.V.P. unid. €	
<b>183126</b>	M3	115	<b>7,00</b>	1
<b>183127</b>	M4	115	<b>7,00</b>	1
<b>183128</b>	M5	115	<b>7,00</b>	1
<b>183129</b>	M6	115	<b>7,00</b>	1

**PARA 183120**



Code	Ø M	L mm	P.V.P. unid. €	
<b>183121</b>	M5	70	<b>6,00</b>	1
<b>183122</b>	M6	70	<b>6,00</b>	1
<b>183123</b>	M8	70	<b>6,00</b>	1
<b>183124</b>	M10	70	<b>6,00</b>	1

## Llave de fleje para filtros



### Para extracción de filtros de aceite

Code	Ø Filtro	L mm	P.V.P. unid. €	
<b>198852</b>	65-110	240	<b>22,50</b>	6
<b>198857</b>	110-155	280	<b>23,00</b>	6

Se suministra en blister

### REPUESTO DE FLEJE

Code	Ø Filtro	P.V.P. unid. €	
<b>198851</b>	65-110	<b>2,90</b>	6
<b>198856</b>	110-155	<b>3,40</b>	6

Válido para 198852, 198857, 198850, 198855

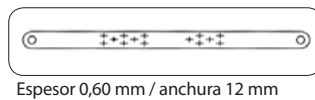

## Llave de fleje para filtros



### Para extracción de filtros de aceite

- Tornillo moleteado de Ø 40 mm
- Cuerpo de aluminio
- Terminación aluminio pintado rugoso
- Fleje de acero de repuesto (ver encima)

Code	Ø Filtro	L mm	P.V.P. unid. €	
<b>198850</b>	65-110	215	<b>11,00</b>	6
<b>198855</b>	110-155	260	<b>13,00</b>	6

Se suministra en blister

## Llave para filtros de 3 patas

ACERO CR-V



PARA FILTROS 63-120MM

PARA DE 3/8"-1/2"

PATA REDONDA Ø 10 MM

• Incluye adaptador de 1/2" H x 3/8" M

Code	Medida mm	P.V.P. unid. €	
<b>122255</b>	80x80x100	<b>19,00</b>	1

Se suministra en blister

## Llave para filtros de 3 patas

ACERO CR-V



PARA FILTROS 63-102MM

PATA PLANA 13 X 4 MM

Code	Medida mm	P.V.P. unid. €	
<b>122250</b>	80x80x47	<b>11,00</b>	1



**Soldador eléctrico**

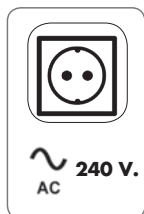

Puntas de recambio

**Bomba desoldadora**



**Pistola termosellante**

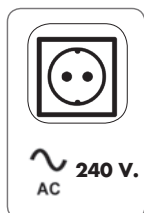

Incluye 2 barras de cola de 11,2x200mm



Incluye pie metálico

**Barras de cola**

**Color Translúcido**



Medida: 11,2x200mm  
Peso: 20 gr.

**Empleo en trabajos de electrónica**

• Punta del soldador niquelada para mayor eficiencia

Code	Potencia W	Ø punta mm	P.V.P. unid. €	
<b>190580</b>	30	4	<b>12,59</b>	1
<b>190590</b>	60	6	<b>14,53</b>	1
<b>190596</b>	80	8	<b>19,55</b>	1

**PUNTAS DE RECAMBIO**

<b>190581</b>	para code 190580	<b>1,90</b>	1
<b>190591</b>	para code 190590	<b>2,10</b>	1
<b>190597</b>	para code 190596	<b>2,50</b>	1

Se suministra en blister

**INSTRUCCIONES DE USO**

Succión del estaño líquido presionando con el dedo

Code	Dimensión mm	P.V.P. unid. €	
<b>190595</b>	200x20	<b>7,00</b>	1

Se suministra en blister

**INSTRUCCIONES DE USO**

- Introducir una barra de cola en el alojamiento de entrada
- Precalear entre 3 -5 minutos
- Presionar el gatillo y aplicar la cola

**UTILIZACION:**

- Madera
- Plástico
- Metal ligero
- Cartón
- Cerámica
- Tela

- Gatillo dispensador con control de flujo
- Boquilla antigoteo

Code	P.V.P. unid. €	
<b>198892</b>	<b>9,30</b>	6

- En bolsa de plástico con colgador
- Cada bolsa incluye 10 barras de cola

Code	Nº piezas	P.V.P. bolsa €	
<b>198895</b>	10	<b>5,00</b>	20

## Aplicador sellante de alta potencia

RATIO FUERZA  
**18:1**  
ANTIGOTEO

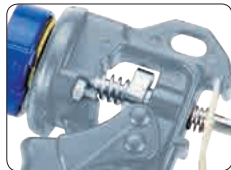

PARA  
CARTUCHOS  
DE 310 ML

Leva reforzada de 9 mm de espesor

### Empleo con productos de ALTA densidad

- Pistola de fricción de varilla cilíndrica
- Tuerca de fricción de Acero
- Mango reforzado en Aluminio de alta calidad

Code	L mm	D mm	P.V.P. unid. €	
<b>198807</b>	225	50	<b>15,00</b>	6

## Aplicador sellante reforzado

RATIO FUERZA  
**12:1**  
ANTIGOTEO



PARA  
CARTUCHOS  
DE 310 ML

### Empleo con productos de media densidad

- Pistola de fricción de varilla cilíndrica
- Tuerca de fricción de Acero
- Mango reforzado en Aluminio de alta calidad

Code	L mm	D mm	P.V.P. unid. €	
<b>198805</b>	250	50	<b>6,60</b>	12

## Aplicador para mortero de alta potencia

RATIO FUERZA  
**24:1**  
ANTIGOTEO

PARA CARTUCHOS  
DE 310, 400 Y 600 ML



Tuerca de aluminio

Varilla perforada de Ø 7,8 mm

Placa interior metálica de 3,5 mm

Mango de aluminio reforzado

Leva reforzada de 9 mm de espesor

### Empleo con productos de ALTA densidad

Code	L mm	D mm	P.V.P. unid. €	
<b>198818</b>	380	50	<b>18,50</b>	2

Boquillas de recambio a continuación

## Aplicador para mortero

RATIO FUERZA  
**12:1**

PARA  
CARTUCHOS  
DE 310 ML



198815

PARA CARTUCHOS  
DE 310, 400 Y 600 ML



198810

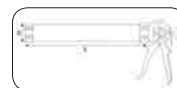

- Cuerpo tubular fabricado en Aluminio
- Incluye boquilla de plástico (disponibles recambios)

### Empleo con productos de media densidad



198816  
Boquillas de recambio

Code	L mm	D mm	P.V.P. unid. €	
<b>198810</b>	250	50	<b>9,50</b>	2
<b>198815</b>	380	50	<b>12,00</b>	2
BOQUILLAS DE RECAMBIO				
<b>198816</b>	Para 198810/815/818		<b>1,00</b>	12

**Aplicador para poliuretano**

**PUNTA DE ACERO  
INOXIDABLE**

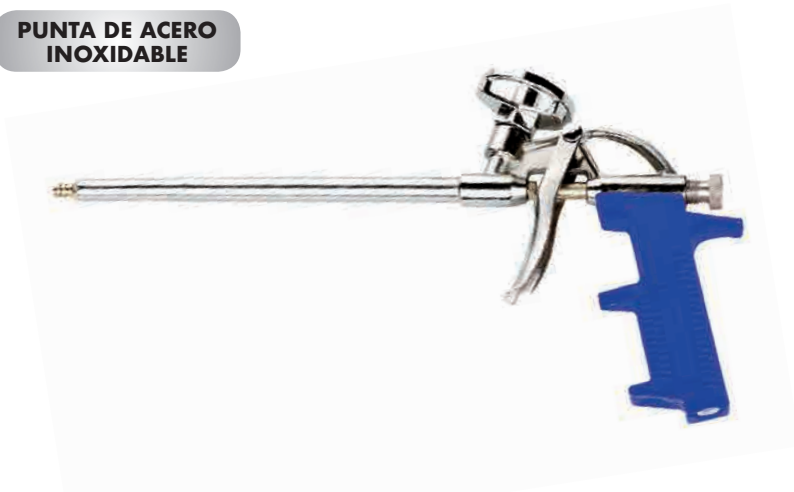

**Para aplicación de espuma de poliuretano**

- Cuerpo del aplicador de zinc
- Mango de plástico duro con forma ergonómica
- Se suministra con 2 protectores para la punta

Code	L mm	P.V.P. unid. €	
<b>198820</b>	350	<b>19,00</b>	2

**Aplicador para poliuretano teflonado**

**PUNTA DE ACERO  
INOXIDABLE**



**VALVULA RECUBIERTA DE TEFLON**

**Para aplicación de espuma de poliuretano**

- Cuerpo reforzado de aluminio
- Varilla interior y válvula teflonadas
- Tornillo de regulación de espuma ergonómico
- Se suministra con 2 protectores para la punta

Code	L mm	P.V.P. unid. €	
<b>198821</b>	350	<b>25,00</b>	2

**Varilla mezcladora**



**Para batir pinturas, barnices, etc.**

- Varilla hexagonal y fleje fabricados en Acero
- Presentación pintado
- Se suministra con colgador de goma

Code	Ø cabeza mm	L mm	Ø mango mm	P.V.P. unid. €	
<b>198826</b>	60	400	8	<b>2,28</b>	6
<b>198828</b>	80	400	8	<b>2,46</b>	6
<b>198830</b>	100	600	10	<b>3,90</b>	6
<b>198832</b>	120	600	14	<b>5,65</b>	6

**Varilla mezcladora reforzada**

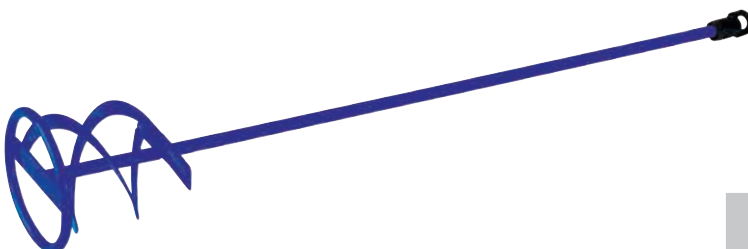

**Para batir morteros y materiales muy viscosos**

- Varilla hexagonal y fleje fabricados en Acero
- Presentación pintado
- Se suministra con colgador de goma

Code	Ø cabeza mm	L mm	Conexión mango	P.V.P. unid. €	
<b>198835</b>	100	600	M14	<b>11,00</b>	6

## Bomba de engrase a palanca

PRESION MAXIMA



500 BAR



CAPACIDAD

CARTUCHO	GRANEL
400 cc	500 cc

- Cuerpo cromado
- Palanca con empuñadura ergonómica
- Con tornillo para purgado

### COMPOSICION

- 1 Racor rígido de 150 mm / 6"
- 1 Racor flexible de 300 mm / 12" (198861)
- 2 Boquillas hidráulicas (198863)

Code	L mm	P.V.P. unid. €	
198860	400	17,80	1

### ACCESORIOS

Code	L mm	P.V.P. unid. €	
198861	300	3,50	1
198863	38	1,60	1



198861  
Racor flexible + boquilla



198863  
Boquilla hidráulica



## Inyector de aceite



Para vaciar y rellenar cualquier líquido no corrosivo

### UTILIZACION:

Para transmisiones, diferenciales, cajas de cambio, cárteres...

- Incluye manguera flexible de 300 mm

Code	L mm	P.V.P. unid. €	
198865	400	12,44	1

En caja de cartón individual

## Bomba manual de transvase

PARA BIDONES  
60-200 L

ENTREGA 14 L/MIN



EXTENSIBLE

457 mm  
890 mm

Para trasvasar todo tipo de líquidos no corrosivos

- Conexión a bidón M2"G
- Fabricado en Acero y Aluminio

Code	L mm	P.V.P. unid. €	
198885	457/890	32,74	1

**Bidón metálico**



198875



198876



198870

- Homologado Norma UN, para transporte de hidrocarburos
- Fabricado en chapa de Acero de 0,8 mm
- Cierre especial anti-fugas
- Se suministra con boquilla flexible

Code	L	Medida mm	P.V.P. unid. €	
<b>198870</b>	10	300x130x405	<b>28,66</b>	1
<b>198875</b>	20	360x170x470	<b>33,66</b>	1
ACCESORIOS				
<b>198876</b>	Boquilla flexible		<b>7,34</b>	1

**Aceitera metálica**



198880

198882

- Se suministra con 2 racores:  
1 racor flexible de 120 mm y 1 racor rígido de 120 mm
- Fabricado en chapa de Acero de 0,8 mm

Code	Capacidad cc	Ø mm	P.V.P. unid. €	
<b>198880</b>	300	70	<b>4,90</b>	1
<b>198882</b>	500	80	<b>5,60</b>	1

**Alicate Sacabocados de alta potencia**

**6 DIAMETROS DE BOCA:  
2, 2'5, 3, 3'5, 4, 4'5 MM**

**Empleo en perforación  
en cuero, textil y plástico**



- Cuerpo pintado para evitar la oxidación
- Mangos ergonómicos con protector plástico
- Tambor giratorio con 6 diámetros de punzones
- Articulación al perforar que reduce el esfuerzo
- Muelle de apertura y palanca de cierre

Code	L mm	P.V.P. unid. €	
<b>111445</b>	250	<b>15,30</b>	1

Se suministra en blister

**Tensor para abrazaderas**



**INSTRUCCIONES DE USO**



1. Colocar la abrazadera
2. Atar la abrazadera
3. Cortar la abrazadera

- Presión del tensado de la abrazadera regulable
- Tensa y corta abrazaderas entre 2'2 y 4'8 mm

Code	Medida mm	P.V.P. unid. €	
<b>108395</b>	160x130	<b>30,70</b>	1



## 15 Herramienta Antichispa



Maceta de Cobre 285



Maceta de Latón 285



Alicate Al-Br 286



Llave fija Al-Br 287



Llave de golpe Al-Br 288



Maceta Al-Br 289



Cuña Al-Br 289



Juego vasos Al-Br 290



Espátula Al-Br 291



Tenaza Cu-Be 292



Llave combinada Cu-Be 293



Llave de golpe Cu-Be 294



Martillo de bola Cu-Be 295



Cortafrios Cu-Be 295



Rasqueta Cu-Be 297



Pala Cu-Be 297

CONSULTAR DISPONIBILIDAD DE CUALQUIER OTRA HERRAMIENTA ANTICHISPA

**HERRAMIENTAS ANTICHISPA**



Nuestra gama de herramientas antichispa ha sido concebida para su uso en entornos potencialmente explosivos, en los cuales el uso de las herramientas de acero no son recomendables por su tendencia a generar chispas que pueden provocar incendios o incluso explosiones. Las herramientas fabricadas con materiales no ferrosos reducen el riesgo de chispas inflamables, además de tener una serie de características especiales de seguridad antimagnética y resistencia a la corrosión.

**ZONAS ATEX**



**Zonas EX.** La directiva 1999/92/CE define las zonas y la seguridad de las personas trabajando en zonas con peligro de explosión. La presencia de gases, líquidos o polvo, sobre todo en industrias petroquímicas, minas o industrias similares producen esos ambientes potencialmente explosivos.

GASES VAPORES	Zona 0	Atmosfera con mezcla de aire y sustancias inflamables de manera frecuente		<b>Cu-Be</b>
	Zona 1	Atmosfera con mezcla de aire y sustancias inflamables de manera ocasional	<b>Al-Br</b>	<b>Cu-Be</b>
	Zona 2	Atmosfera con mezcla de aire y sustancias inflamables posible, pero en cortos periodos	<b>Al-Br</b>	<b>Cu-Be</b>
POLVO	Zona 20	Atmosfera con nube de polvo combustible de manera frecuente, continua o durante largos periodos		<b>Cu-Be</b>
	Zona 21	Atmosfera con nube de polvo combustible de manera ocasional	<b>Al-Br</b>	<b>Cu-Be</b>
	Zona 22	Atmosfera con con nube de polvo combustible, pero en cortos periodos	<b>Al-Br</b>	<b>Cu-Be</b>

**GARANTIA**



Nuestras herramientas antichispa están fabricadas siguiendo las normas internacionales de seguridad en procesos certificados por los institutos BAM y FM. Nuestras herramientas antichispa siguen las normas internacionales de dimensiones, capacidad de corte y dureza.

**INSTRUCCIONES DE USO**



Al carecer de la dureza de las herramientas convencionales, deben ser utilizadas con especial cuidado, sobre todo en uso y temperatura de exposicion. Solo serán sustituidas en caso de que no superen la dureza minima (Al-Br 30Hrc, Cu-Be 40HRc). No usar herramientas con mas de 65% de contenido en cobre en contacto con acetileno, por su capacidad explosiva.

**Maceta octogonal de Cobre**



- Dureza inferior al Al-Br y Cu-Be
- Desgaste importante durante el uso

**Maceta octogonal de Latón**



Code	Peso gr	Material	P.V.P. unid. €
<b>129120</b>	900	Cobre	<b>94,00</b>
<b>129121</b>	1350	Cobre	<b>130,00</b>
<b>129122</b>	1800	Cobre	<b>170,00</b>
<b>129123</b>	4500	Cobre	<b>390,00</b>
<b>129124</b>	7200	Cobre	<b>565,00</b>
<b>129125</b>	9000	Cobre	<b>681,00</b>

Code	Peso gr	Material	P.V.P. unid. €
<b>129020</b>	900	Latón	<b>79,00</b>
<b>129021</b>	1350	Latón	<b>105,00</b>
<b>129022</b>	1800	Latón	<b>140,00</b>
<b>129023</b>	4500	Latón	<b>349,00</b>
<b>129024</b>	7200	Latón	<b>430,00</b>
<b>129025</b>	9000	Latón	<b>598,00</b>

# Herramienta antichispa

**ALUMINIO**  
**BRONCE**

- Dureza aprox. 25-30 HRC (221-291 Brinell)
- Límite elástico 450-500 N/mm<sup>2</sup>
- Resistencia a la tracción 800 N/mm<sup>2</sup>
- Contenido en aluminio 10-12 %
- Contenido en níquel 4-6 %

## Alicate universal

Al-Br



Code	L mm	L "	P.V.P. unid. €
<b>127010</b>	160	6	<b>104,00</b>
<b>127012</b>	200	8	<b>121,00</b>

## Alicate de puntas semirredondas

Al-Br



Code	L mm	L "	P.V.P. unid. €
<b>127015</b>	160	6	<b>100,00</b>
<b>127016</b>	200	8	<b>112,00</b>

## Alicate de corte diagonal

Al-Br



Code	L mm	L "	P.V.P. unid. €
<b>127018</b>	160	6	<b>101,00</b>
<b>127019</b>	200	8	<b>108,00</b>

## Tenaza pico de loro

Al-Br



Code	L mm	L "	P.V.P. unid. €
<b>127030</b>	250	10	<b>169,00</b>
<b>127031</b>	300	12	<b>199,00</b>

## Destornillador boca plana

Al-Br



Code	Ø mm	mm	P.V.P. unid. €
<b>127310</b>	3,0	75	<b>18,00</b>
<b>127311</b>	5,0	100	<b>23,00</b>
<b>127312</b>	6,0	150	<b>29,00</b>
<b>127313</b>	8,0	200	<b>44,00</b>

## Destornillador boca Phillips

Al-Br



Code	Ø	mm	P.V.P. unid. €
<b>127316</b>	PH1	100	<b>21,00</b>
<b>127317</b>	PH2	150	<b>25,00</b>
<b>127318</b>	PH3	200	<b>37,00</b>



**Llave fija de 2 bocas**

Al-Br



Code	mm	P.V.P. unid. €
127100	6x7	18,00
127101	8x9	19,00
127102	10x11	22,00
127103	12x13	29,00
127104	14x15	38,00
127105	16x18	45,00
127106	17x19	47,00
127107	20x22	66,00
127108	21x23	71,00
127109	24x27	108,00
127110	25x28	117,00
127111	27x29	125,00
127112	30x32	139,00
127113	34x36	153,00
127114	41x46	207,00

**Llave de estrella acodada**

Al-Br



Code	mm	P.V.P. unid. €
127180	6x7	18,50
127181	8x9	20,00
127182	10x11	22,00
127183	12x13	27,00
127184	14x15	33,00
127185	16x18	43,00
127186	17x19	47,00
127187	20x22	57,00
127188	21x23	62,00
127189	25x28	96,00
127190	27x29	121,00
127191	30x32	134,00

**Llave combinada**

Al-Br



Code	mm	P.V.P. unid. €
127130	8	28,00
127131	9	30,50
127132	10	34,50
127133	11	39,50
127134	12	40,50
127135	13	42,00
127136	14	44,00
127137	15	47,00
127138	16	49,50
127139	17	50,50
127140	18	53,00
127141	19	54,00
127142	20	59,00

Code	mm	P.V.P. unid. €
127143	21	66,00
127144	22	70,50
127145	23	77,00
127146	24	83,00
127147	25	95,00
127148	26	107,50
127149	27	118,00
127150	28	127,00
127151	29	135,00
127152	30	141,00
127153	31	149,00
127154	32	153,00

**CONSULTAR DISPONIBILIDAD DE CUALQUIER OTRA HERRAMIENTA ANTICHISPA**

# Herramienta antichispa

## Llave fija de golpe

Al-Br



Code	mm	P.V.P. unid. €
127200	17	43,00
127201	19	46,00
127202	22	49,00
127203	24	54,00
127204	27	66,00
127205	30	79,00
127206	32	94,00
127207	36	109,00
127208	41	133,00
127209	46	169,00
127210	50	186,00
127211	55	201,00
127212	60	266,00
127213	65	339,00
127214	70	398,00
127215	75	464,00
127216	80	573,00

## Llave de estrella plana de golpe

Al-Br



Code	mm	P.V.P. unid. €
127230	17	48,00
127231	19	53,00
127232	22	55,00
127233	24	63,00
127234	27	76,00
127235	30	88,00
127236	32	96,00
127237	36	109,00
127238	41	143,00
127239	46	158,00
127240	50	189,00
127241	52	234,00
127242	55	239,00
127243	60	249,00
127244	65	289,00
127245	70	333,00
127246	75	381,00
127247	80	415,00
127248	90	591,00
127249	100	828,00

## Llave ajustable

Al-Br



Code	L mm	Ø "	P.V.P. unid. €
127160	200	24	103,00
127161	250	30	136,00
127162	300	36	168,00
127163	375	46	249,00

## Llave Stillson para tubo

Al-Br



Code	L mm	Ø "	P.V.P. unid. €
127170	250	30	175,00
127171	350	50	280,00
127172	450	60	395,00
127173	600	75	581,00

## Llave de carraca de andamio

Al-Br



Code	mm	P.V.P. unid. €
127199	19x22	494,00

**Maceta octogonal**

Al-Br



Code	Peso gr	P.V.P. unid. €
<b>127412</b>	1000	<b>119,00</b>
<b>127413</b>	1500	<b>173,00</b>
<b>127414</b>	2000	<b>199,00</b>
<b>127415</b>	2500	<b>247,00</b>
<b>127416</b>	3000	<b>293,00</b>
<b>127417</b>	4500	<b>443,00</b>
<b>127418</b>	5000	<b>499,00</b>
<b>127419</b>	8000	<b>897,00</b>
<b>127420</b>	9900	<b>1.044,00</b>

**Martillo de mecánico**

Al-Br



Code	Peso gr	P.V.P. unid. €
<b>127400</b>	500	<b>77,00</b>
<b>127401</b>	1000	<b>139,00</b>
<b>127402</b>	1500	<b>198,00</b>
<b>127403</b>	2000	<b>249,00</b>

**Martillo de bocas de nylon**

Al-Br



Code	Peso gr	P.V.P. unid. €
<b>127425</b>	800	<b>120,00</b>

**Martillo de bola**

Al-Br



Code	Peso gr	P.V.P. unid. €
<b>127406</b>	450	<b>58,00</b>
<b>127407</b>	680	<b>88,00</b>
<b>127408</b>	910	<b>104,00</b>
<b>127409</b>	1130	<b>129,00</b>

**Cuña**

Al-Br



Code	LxA mm	H mm	P.V.P. unid. €
<b>127284</b>	100x50	10-0	<b>26,00</b>
<b>127285</b>	135x50	18-0	<b>64,00</b>
<b>127286</b>	150x40	8-0	<b>27,00</b>
<b>127287</b>	150x25	8-0	<b>18,00</b>
<b>127288</b>	150x25	13-0	<b>30,00</b>
<b>127289</b>	150x50	13-0	<b>56,00</b>
<b>127290</b>	180x13	6-0	<b>26,00</b>
<b>127291</b>	180x32	13-0	<b>42,00</b>
<b>127292</b>	180x50	19-0	<b>97,00</b>
<b>127293</b>	200x20	30-0	<b>69,00</b>
<b>127294</b>	200x30	30-0	<b>104,00</b>
<b>127295</b>	200x40	40-0	<b>179,00</b>
<b>127296</b>	200x50	12-0	<b>69,00</b>
<b>127297</b>	230x40	20-0	<b>105,00</b>
<b>127298</b>	250x40	30-0	<b>169,00</b>
<b>127299</b>	300x50	40-0	<b>297,50</b>

**Cortafríos**

Al-Br



Code	AxL mm	P.V.P. unid. €
<b>127325</b>	22x150	<b>53,00</b>
<b>127326</b>	22x200	<b>59,00</b>
<b>127327</b>	24x250	<b>94,00</b>

# Herramienta antichispa

## Juego de llaves de vaso de 1/2"

Al-Br



### COMPOSICION

18 Vasos 10, 11, 12, 13, 14, 15, 17, 18, 19, 20, 21, 22, 23, 24, 27, 30, 32 mm	2 Alargaderas 125, 250 mm
1 Carraca 250 mm	1 Berbiqui 390 mm
1 Junta universal 75 mm	1 Mango en T 250 mm

1/2

Code	Nº Piezas	P.V.P. unid. €
<b>127500</b>	24	<b>2.338,00</b>

## Juego de llaves de vaso de 3/4"

Al-Br



### COMPOSICION

11 Vasos 21, 24, 27, 30, 32, 34, 36, 38, 41, 46, 50 mm	1 Alargadera 200 mm
1 Carraca 320 mm	1 Mango en T 400 mm

3/4

Code	Nº Piezas	P.V.P. unid. €
<b>127501</b>	14	<b>3.048,00</b>

## Llave de carraca

Al-Br



Code		P.V.P. unid. €
<b>127502</b>	1/2"	<b>179,00</b>
<b>127503</b>	3/4"	<b>351,00</b>

CONSULTAR DISPONIBILIDAD DE CUALQUIER OTRA HERRAMIENTA ANTICHISPA

**Llave macho hexagonal**

Al-Br



Code	mm	P.V.P. unid. €
<b>127270</b>	2	<b>26,00</b>
<b>127271</b>	3	<b>27,00</b>
<b>127272</b>	4	<b>28,00</b>
<b>127273</b>	5	<b>29,50</b>
<b>127274</b>	6	<b>30,50</b>
<b>127275</b>	7	<b>34,00</b>
<b>127276</b>	8	<b>36,00</b>
<b>127277</b>	9	<b>39,00</b>
<b>127278</b>	10	<b>40,00</b>
<b>127279</b>	12	<b>48,00</b>
<b>127280</b>	14	<b>63,00</b>
<b>127281</b>	17	<b>78,50</b>
<b>127282</b>	19	<b>86,00</b>

**Espátula**

Al-Br



Code	AxL mm	P.V.P. unid. €
<b>127350</b>	25x200	<b>44,00</b>
<b>127351</b>	30x200	<b>47,00</b>
<b>127352</b>	40x200	<b>48,00</b>
<b>127353</b>	50x200	<b>63,00</b>
<b>127354</b>	60x200	<b>73,00</b>

**Espátula flexible**

Al-Br



Code	AxL mm	P.V.P. unid. €
<b>127355</b>	75x200	<b>75,00</b>
<b>127356</b>	80x200	<b>83,00</b>
<b>127357</b>	100x200	<b>88,00</b>

**Rasqueta hoja larga**

Al-Br



Code	L mm	P.V.P. unid. €
<b>127361</b>	75	<b>120,00</b>
<b>127362</b>	100	<b>144,00</b>
<b>127363</b>	150	<b>229,00</b>

**Rasqueta**

Al-Br



Code	L mm	P.V.P. unid. €
<b>127360</b>	270	<b>89,00</b>

**Pala redonda**

Al-Br



Code	L mm	P.V.P. unid. €
<b>127600</b>	20x240x990	<b>236,00</b>

# Herramienta antichispa

**COBRE**  
**BERILIO**

- Dureza aprox. 35-40 HRC (283-365 Brinell)
- Límite elástico 840-880 N/mm<sup>2</sup>
- Resistencia a la tracción 1250 N/mm<sup>2</sup>
- Contenido en Berilio 1,8-2 %
- Contenido en Ni+Co 0,2-1,2 %

## Alicate universal

Cu-Be



Code	L mm	L "	P.V.P. unid. €
<b>128010</b>	160	6	<b>166,00</b>
<b>128012</b>	200	8	<b>199,00</b>

## Alicate de puntas semirredondas

Cu-Be



Code	L mm	L "	P.V.P. unid. €
<b>128015</b>	160	6	<b>159,00</b>
<b>128016</b>	200	8	<b>179,00</b>

## Alicate de corte diagonal

Cu-Be



Code	L mm	L "	P.V.P. unid. €
<b>128018</b>	160	6	<b>163,00</b>
<b>128019</b>	200	8	<b>177,00</b>

## Tenaza pico de loro

Cu-Be



Code	L mm	L "	P.V.P. unid. €
<b>128030</b>	250	10	<b>231,00</b>
<b>128031</b>	300	12	<b>298,00</b>

## Destornillador boca plana

Cu-Be



Code	Ø mm	↔ mm	P.V.P. unid. €
<b>128310</b>	3,0	75	<b>28,00</b>
<b>128311</b>	5,0	100	<b>37,00</b>
<b>128312</b>	6,0	150	<b>45,00</b>
<b>128313</b>	8,0	200	<b>65,00</b>

## Destornillador boca Phillips

Cu-Be



Code	⊕	↔ mm	P.V.P. unid. €
<b>128316</b>	PH1	100	<b>33,00</b>
<b>128317</b>	PH2	150	<b>42,00</b>
<b>128318</b>	PH3	200	<b>69,00</b>

**Llave fija de 2 bocas**

Cu-Be



Code	mm	P.V.P. unid. €
<b>128100</b>	6x7	<b>27,00</b>
<b>128101</b>	8x9	<b>28,00</b>
<b>128102</b>	10x11	<b>34,50</b>
<b>128103</b>	12x13	<b>44,00</b>
<b>128104</b>	14x15	<b>55,00</b>
<b>128105</b>	16x18	<b>65,00</b>
<b>128106</b>	17x19	<b>69,00</b>
<b>128107</b>	20x22	<b>101,00</b>
<b>128108</b>	21x23	<b>107,00</b>
<b>128109</b>	24x27	<b>161,00</b>
<b>128110</b>	25x28	<b>172,00</b>
<b>128111</b>	27x29	<b>188,00</b>
<b>128112</b>	30x32	<b>219,00</b>
<b>128113</b>	34x36	<b>230,00</b>
<b>128114</b>	41x46	<b>379,00</b>

**Llave de estrella acodada**

Cu-Be



Code	mm	P.V.P. unid. €
<b>128180</b>	6x7	<b>39,00</b>
<b>128181</b>	8x9	<b>43,00</b>
<b>128182</b>	10x11	<b>53,00</b>
<b>128183</b>	12x13	<b>63,00</b>
<b>128184</b>	14x15	<b>74,00</b>
<b>128185</b>	16x18	<b>83,00</b>
<b>128186</b>	17x19	<b>91,00</b>
<b>128187</b>	20x22	<b>115,00</b>
<b>128188</b>	21x23	<b>122,00</b>
<b>128189</b>	25x28	<b>169,00</b>
<b>128190</b>	27x29	<b>199,00</b>
<b>128191</b>	30x32	<b>229,00</b>

**Llave combinada**

Cu-Be



Code	mm	P.V.P. unid. €
<b>128130</b>	8	<b>49,00</b>
<b>128131</b>	9	<b>55,00</b>
<b>128132</b>	10	<b>61,00</b>
<b>128133</b>	11	<b>64,00</b>
<b>128134</b>	12	<b>71,00</b>
<b>128135</b>	13	<b>76,00</b>
<b>128136</b>	14	<b>79,00</b>
<b>128137</b>	15	<b>80,00</b>
<b>128138</b>	16	<b>87,00</b>
<b>128139</b>	17	<b>96,00</b>
<b>128140</b>	18	<b>99,00</b>
<b>128141</b>	19	<b>101,00</b>
<b>128142</b>	20	<b>109,00</b>

Code	mm	P.V.P. unid. €
<b>128143</b>	21	<b>121,00</b>
<b>128144</b>	22	<b>128,00</b>
<b>128145</b>	23	<b>134,00</b>
<b>128146</b>	24	<b>146,00</b>
<b>128147</b>	25	<b>161,00</b>
<b>128148</b>	26	<b>171,00</b>
<b>128149</b>	27	<b>179,00</b>
<b>128150</b>	28	<b>189,00</b>
<b>128151</b>	29	<b>190,00</b>
<b>128152</b>	30	<b>216,00</b>
<b>128153</b>	31	<b>229,00</b>
<b>128154</b>	32	<b>249,00</b>

**CONSULTAR DISPONIBILIDAD DE CUALQUIER OTRA HERRAMIENTA ANTICHISPA**

# Herramienta antichispa

## Llave fija de golpe

Cu-Be



Code	mm	P.V.P. unid. €
128200	17	79,00
128201	19	84,00
128202	22	88,00
128203	24	99,00
128204	27	119,00
128205	30	139,00
128206	32	158,00
128207	36	196,00
128208	41	238,00
128209	46	283,00
128210	50	313,00
128211	55	385,00
128212	60	449,00
128213	65	569,00
128214	70	643,00
128215	75	723,00
128216	80	901,00

## Llave de estrella plana de golpe

Cu-Be



Code	mm	P.V.P. unid. €
128230	17	79,00
128231	19	86,00
128232	22	91,00
128233	24	103,00
128234	27	119,00
128235	30	138,00
128236	32	154,00
128237	36	184,00
128238	41	271,00
128239	46	296,00
128240	50	349,00
128241	52	435,00
128242	55	439,00
128243	60	465,00
128244	65	480,00
128245	70	569,00
128246	75	618,00
128247	80	676,00
128248	90	996,00
128249	100	1284,00

## Llave ajustable

Cu-Be



Code	L mm	Ø "	P.V.P. unid. €
128160	200	24	153,00
128161	250	30	189,00
128162	300	36	226,00
128163	375	46	339,00

## Llave Stillson para tubo

Cu-Be



Code	L mm	Ø "	P.V.P. unid. €
128170	250	30	239,00
128171	350	50	388,00
128172	450	60	589,00
128173	600	75	835,00

## Llave de carraca de andamio

Cu-Be



Code	mm	P.V.P. unid. €
128199	19x22	690,00



**Maceta octogonal**

Cu-Be



Code	Peso gr	P.V.P. unid. €
<b>128412</b>	1000	<b>225,00</b>
<b>128413</b>	1500	<b>289,00</b>
<b>128414</b>	2000	<b>347,00</b>
<b>128415</b>	2500	<b>434,00</b>
<b>128416</b>	3000	<b>534,00</b>
<b>128417</b>	4500	<b>696,00</b>
<b>128418</b>	5000	<b>891,00</b>
<b>128419</b>	8000	<b>1490,00</b>
<b>128420</b>	9900	<b>1890,00</b>

**Martillo de mecánico**

Cu-Be



Code	Peso gr	P.V.P. unid. €
<b>128400</b>	500	<b>101,00</b>
<b>128401</b>	1000	<b>186,00</b>
<b>128402</b>	1500	<b>296,00</b>
<b>128403</b>	2000	<b>389,00</b>

**Martillo de bocas de nylon**

Cu-Be



Code	Peso gr	P.V.P. unid. €
<b>128425</b>	800	<b>176,00</b>

**Martillo de bola**

Cu-Be



Code	Peso gr	P.V.P. unid. €
<b>128406</b>	450	<b>131,00</b>
<b>128407</b>	680	<b>155,00</b>
<b>128408</b>	910	<b>189,00</b>
<b>128409</b>	1130	<b>226,00</b>

**Cuña**

Cu-Be



Code	LxA mm	H mm	P.V.P. unid. €
<b>128284</b>	100x50	10-0	<b>54,00</b>
<b>128285</b>	135x50	18-0	<b>129,00</b>
<b>128286</b>	150x40	8-0	<b>43,00</b>
<b>128287</b>	150x25	8-0	<b>36,00</b>
<b>128288</b>	150x25	13-0	<b>54,00</b>
<b>128289</b>	150x50	13-0	<b>97,00</b>
<b>128290</b>	180x13	6-0	<b>53,00</b>
<b>128291</b>	180x32	13-0	<b>67,00</b>
<b>128292</b>	180x50	19-0	<b>149,00</b>
<b>128293</b>	200x20	30-0	<b>123,00</b>
<b>128294</b>	200x30	30-0	<b>176,00</b>
<b>128295</b>	200x40	40-0	<b>234,00</b>
<b>128296</b>	200x50	12-0	<b>115,00</b>
<b>128297</b>	230x40	20-0	<b>171,00</b>
<b>128298</b>	250x40	30-0	<b>256,00</b>
<b>128299</b>	300x50	40-0	<b>459,00</b>

**Cortafríos**

Cu-Be



Code	AxL mm	P.V.P. unid. €
<b>128325</b>	22x150	<b>74,00</b>
<b>128326</b>	22x200	<b>95,00</b>
<b>128327</b>	24x250	<b>139,00</b>

# Herramienta antichispa

## Juego de llaves de vaso de 1/2"

Cu-Be



### COMPOSICION

18 Vasos 10, 11, 12, 13, 14, 15, 17, 18, 19, 20, 21, 22, 23, 24, 27, 30, 32 mm	2 Alargaderas 125, 250 mm
1 Carraca 250 mm	1 Berbiqui 390 mm
1 Junta universal 75 mm	1 Mango en T 250 mm

1/2

Code	Nº Piezas	P.V.P. unid. €
<b>128500</b>	24	<b>3.499,00</b>

## Juego de llaves de vaso de 3/4"

Cu-Be



### COMPOSICION

11 Vasos 21, 24, 27, 30, 32, 34, 36, 38, 41, 46, 50 mm	1 Alargadera 200 mm
1 Carraca 320 mm	1 Mango en T 400 mm

3/4

Code	Nº Piezas	P.V.P. unid. €
<b>128501</b>	14	<b>3.875,00</b>

## Llave de carraca

Cu-Be



Code		P.V.P. unid. €
<b>128502</b>	1/2"	<b>269,00</b>
<b>128503</b>	3/4"	<b>485,00</b>

CONSULTAR DISPONIBILIDAD DE CUALQUIER OTRA HERRAMIENTA ANTICHISPA

**Llave macho hexagonal**

Cu-Be



Code	mm	P.V.P. unid. €
<b>128270</b>	2	<b>49,00</b>
<b>128271</b>	3	<b>53,00</b>
<b>128272</b>	4	<b>55,00</b>
<b>128273</b>	5	<b>57,50</b>
<b>128274</b>	6	<b>60,50</b>
<b>128275</b>	7	<b>64,00</b>
<b>128276</b>	8	<b>69,00</b>
<b>128277</b>	9	<b>76,00</b>
<b>128278</b>	10	<b>98,00</b>
<b>128279</b>	12	<b>114,00</b>
<b>128280</b>	14	<b>129,00</b>
<b>128281</b>	17	<b>149,00</b>
<b>128282</b>	19	<b>171,00</b>

**Espátula**

Cu-Be



Code	AxL mm	P.V.P. unid. €
<b>128350</b>	25x200	<b>82,00</b>
<b>128351</b>	30x200	<b>86,00</b>
<b>128352</b>	40x200	<b>94,00</b>
<b>128353</b>	50x200	<b>99,00</b>
<b>128354</b>	60x200	<b>108,00</b>

**Espátula flexible**

Cu-Be



Code	AxL mm	P.V.P. unid. €
<b>128355</b>	75x200	<b>145,00</b>
<b>128356</b>	80x200	<b>165,00</b>
<b>128357</b>	100x200	<b>175,00</b>

**Rasqueta hoja larga**

Cu-Be



Code	L mm	P.V.P. unid. €
<b>128361</b>	75	<b>144,00</b>
<b>128362</b>	100	<b>169,00</b>
<b>128363</b>	150	<b>276,00</b>

**Rasqueta**

Cu-Be



Code	L mm	P.V.P. unid. €
<b>128360</b>	270	<b>118,00</b>

**Pala redonda**

Cu-Be



Code	L mm	P.V.P. unid. €
<b>128600</b>	20x240x990	<b>359,00</b>

# Expositores

## Expositor mural

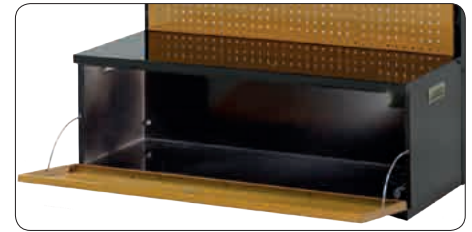

Cajón inferior con cerradura

- Incluye fluorescente para el cabezal
- Cajón inferior de carga

EXPOSITOR MURAL		
Code	Tamaño mm	P.V.P. unid. €
<b>113503</b>	1000x450x2280	<b>370,72</b>

Incluye 30 ganchos code 113504

## Ganchos para expositor



GANCHO SIMPLE		
Code	Tamaño mm	P.V.P. unid. €
<b>113504</b>	200x5	<b>1,72</b>



GANCHO PARA ALICATES		
Code	Tamaño mm	P.V.P. unid. €
<b>113536</b>	200x6	<b>7,42</b>

- Válido para todos los ganchos
- Fabricado en chapa de 1 mm de grosor
- Pie de apoyo de 250 mm de profundidad

Code	Medida mm	P.V.P. unid. €
<b>113534</b>	350x750	<b>112,69</b>

## Expositor multiherramienta



















# NOTAS

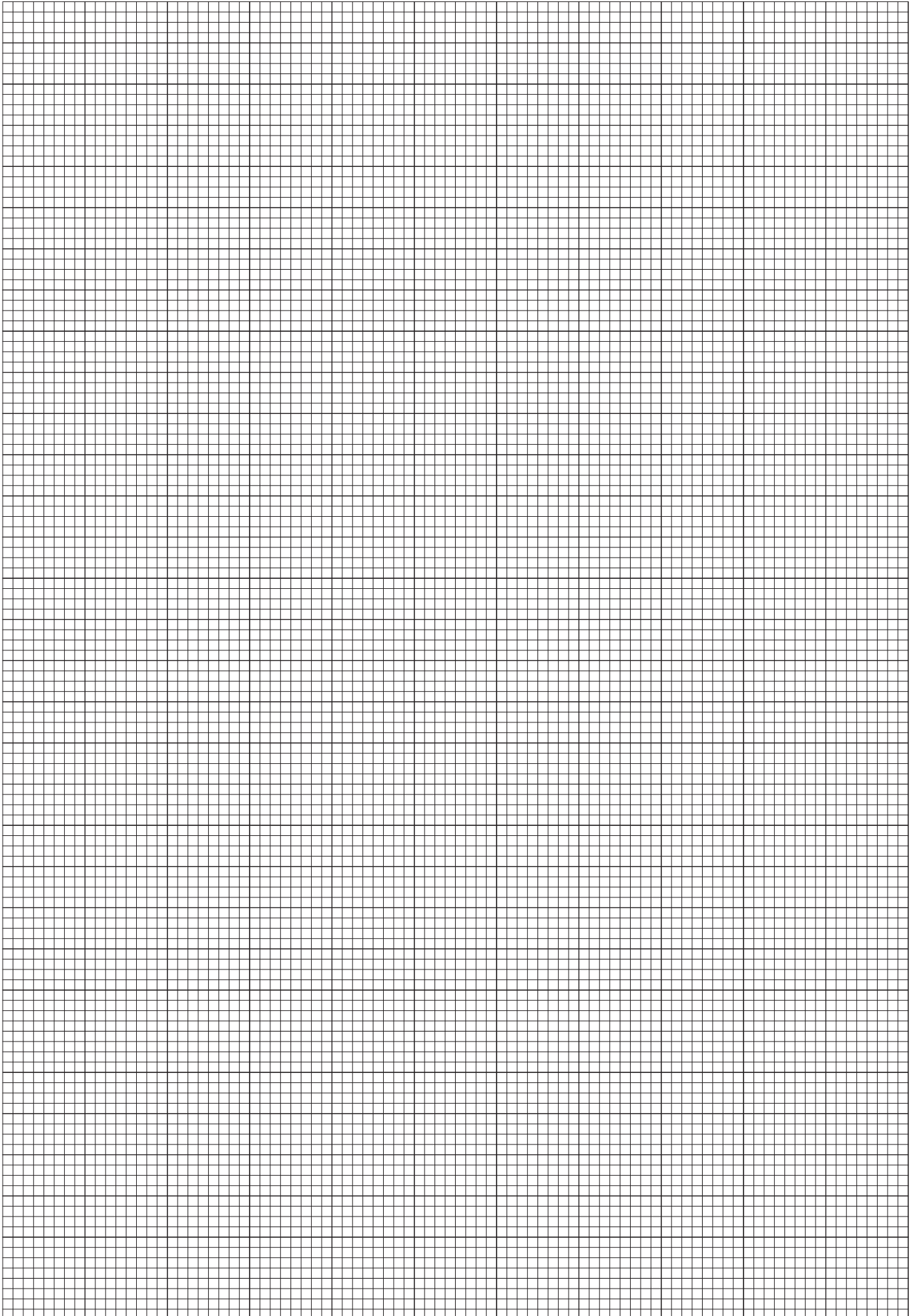

**NOTAS**

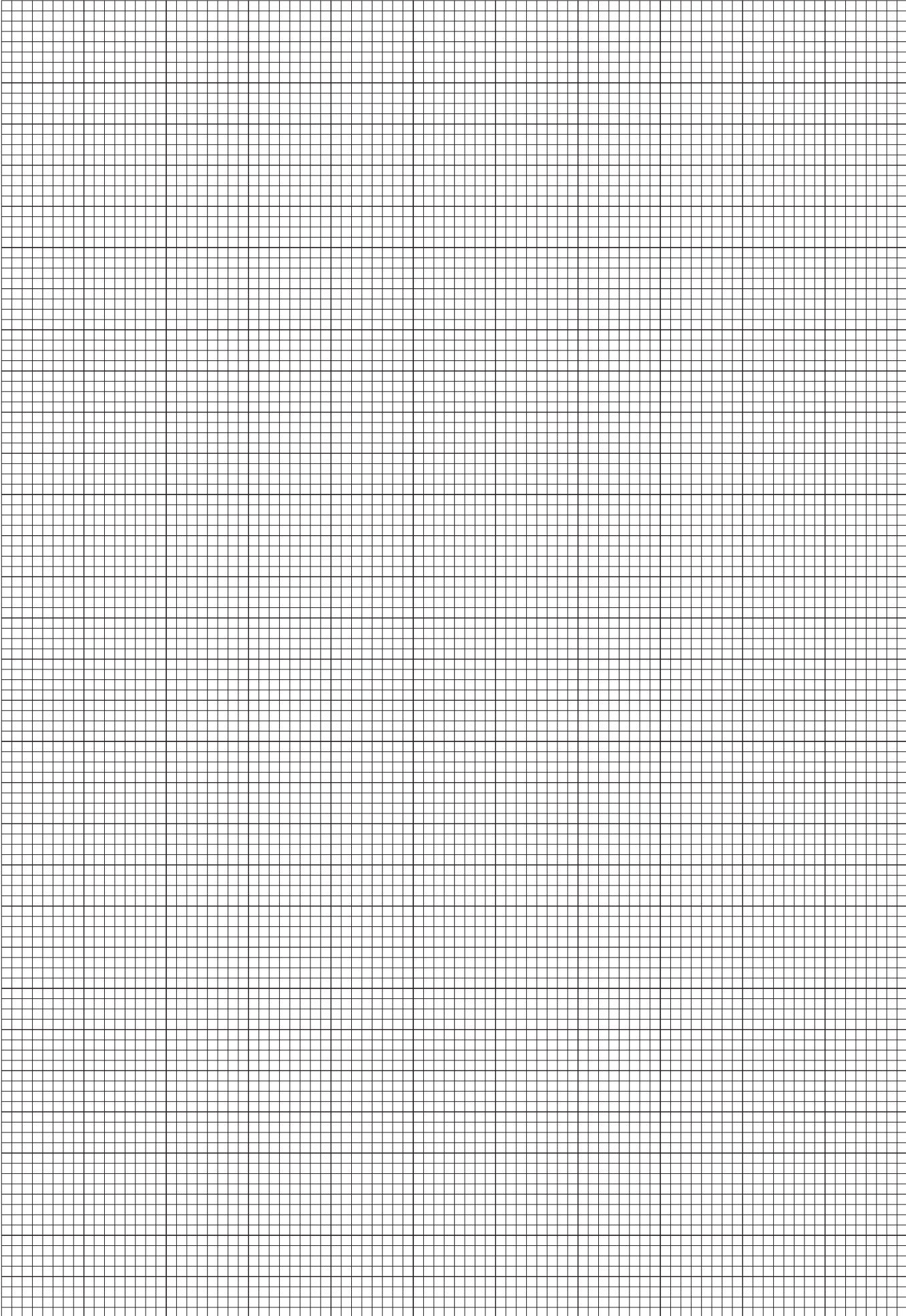

# WWW.ALYCOTOOLS.COM

Accesible desde la web, un modo fácil y ágil para consultar el catálogo

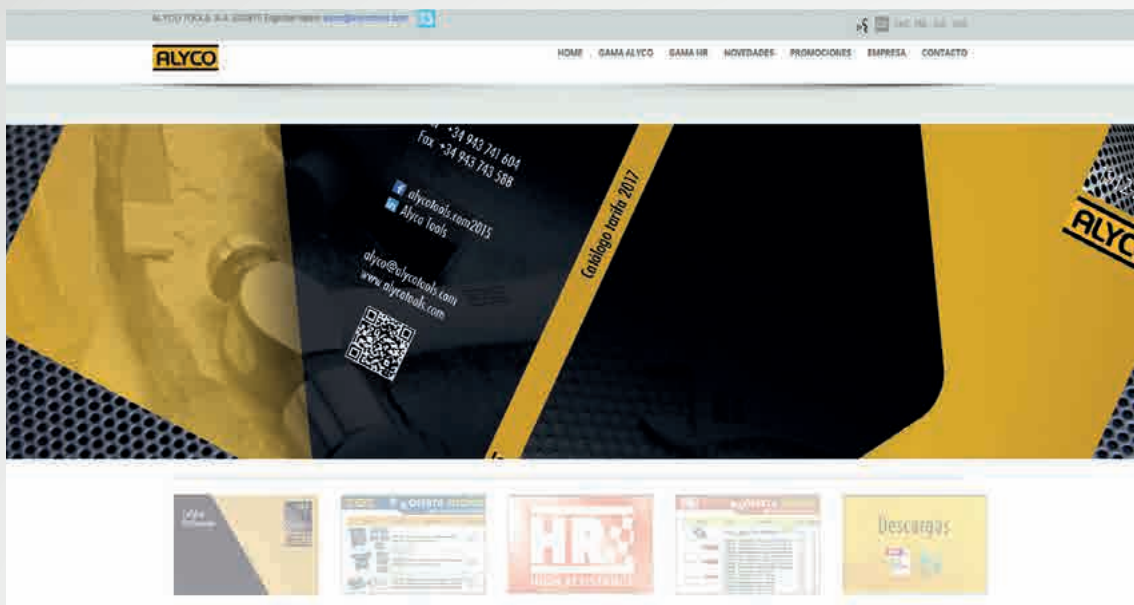

## CATALOGO INTERACTIVO

Accesible desde la web, un modo fácil y ágil para consultar el catálogo

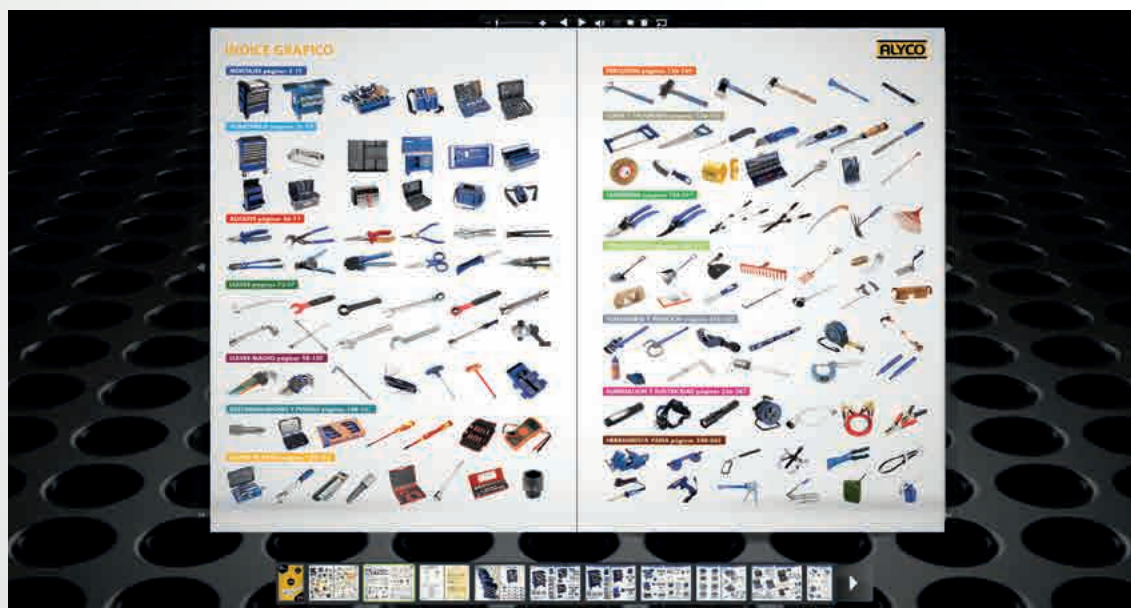

## DESCARGA DE FICHEROS

Accesible desde la web, un modo fácil y ágil para consultar el catálogo



Catálogo completo



Catálogo por familias



Código, descripción, PVP, código de barras, nº página, embalaje.

# DESCARGA DE DOCUMENTOS

Imágenes, certificados, características y manuales de instrucción en [www.raizferretera.com](http://www.raizferretera.com)

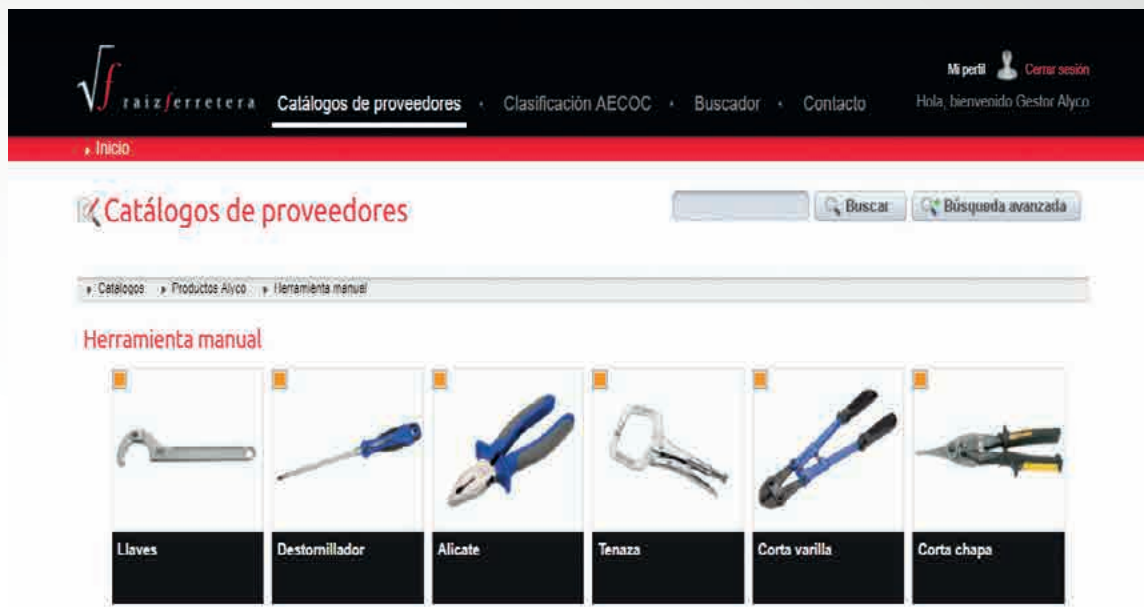

## CONTACTO GENERAL



(34) 943 741 604



(34) 943 743 588



[alyco@alycotools.com](mailto:alyco@alycotools.com)



ALYCOTOOLS



@alycotools.com2015



ALYCO TOOLS



**Respuesta inmediata**



**Comunicación global**



**Servicio internacional**



**Rapidez de respuesta**

# ALYCO NUEVAS INSTALACIONES

Polígono Industrial Itziar, T1 - 20829 Itziar-Deba (Spain)

ENERO 2020

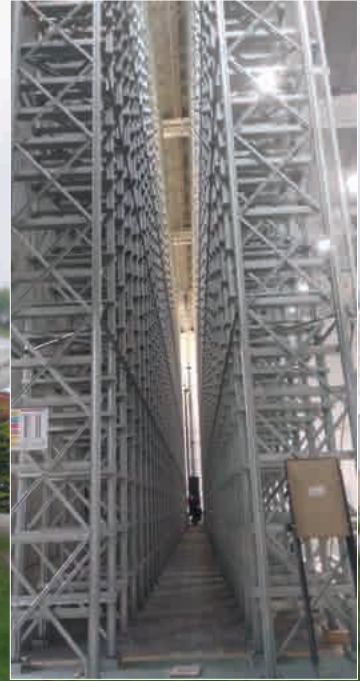





Reino Unido

IRLANDA DEL NORTE

Irlanda

INGLATERRA

GALES

Países Bajos

Bélgica

Luxemburgo

Francia

Suiza

España

Portugal

Marruecos

Túnez

Argelia



**ALYCO**



# OBRA SOCIAL



# ALYCO CON EL DEPORTE





**Polígono Industrial Itziar, T1  
20829 Itziar-Deba (Spain)**

**Tel +34 943 741 604  
Fax +34 943 743 588**

**f alycotools.com2015  
in Alyco Tools**

**alyco@alycotools.com  
www.alycotools.com**

